

Mark	Stone Type	Quantity	Area	
			Imperial	Metric
A1	ST-1	1	1.296 SF	0.120 m ²

Abbreviations
 FE - Finished Edge QME - Quirk Mitre Edge

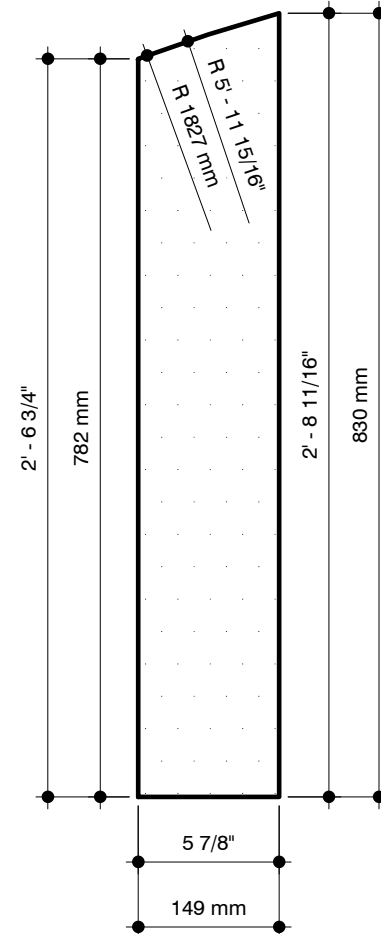

Stone Project Example

6250 Westpark Suite 218 Houston Texas 77057

Date: 02/16/09	Material: Porto Granite	Finish: Polished	Thickness: 2cm	Ticket Number: TA1
----------------	-------------------------	------------------	----------------	---------------------------

Mark	Stone Type	Quantity	Area	
			Imperial	Metric
A2	ST-1	1	1.010 SF	0.094 m ²

Abbreviations
 FE - Finished Edge QME - Quirk Mitre Edge

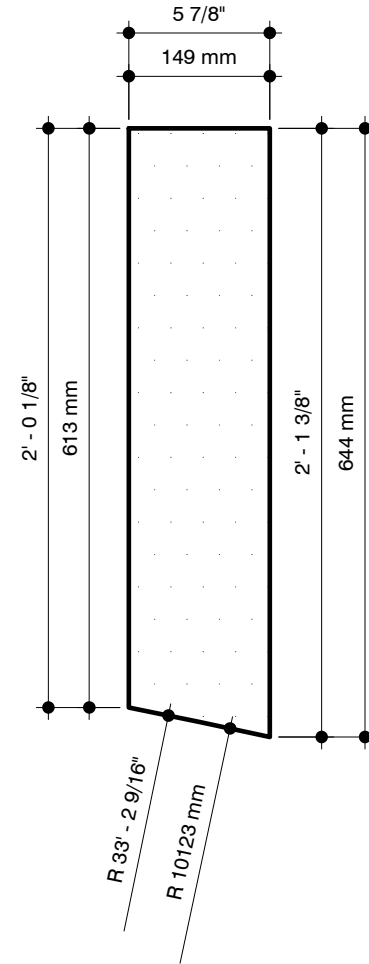

Stone Project Example

6250 Westpark Suite 218 Houston Texas 77057

Date: 02/16/09

Material: Porto Granite

Finish: Polished

Thickness: 2cm

Ticket Number: **TA2**

Mark	Stone Type	Quantity	Area	
			Imperial	Metric
A3	ST-1	1	1.690 SF	0.157 m ²

Abbreviations
 FE - Finished Edge QME - Quirk Mitre Edge

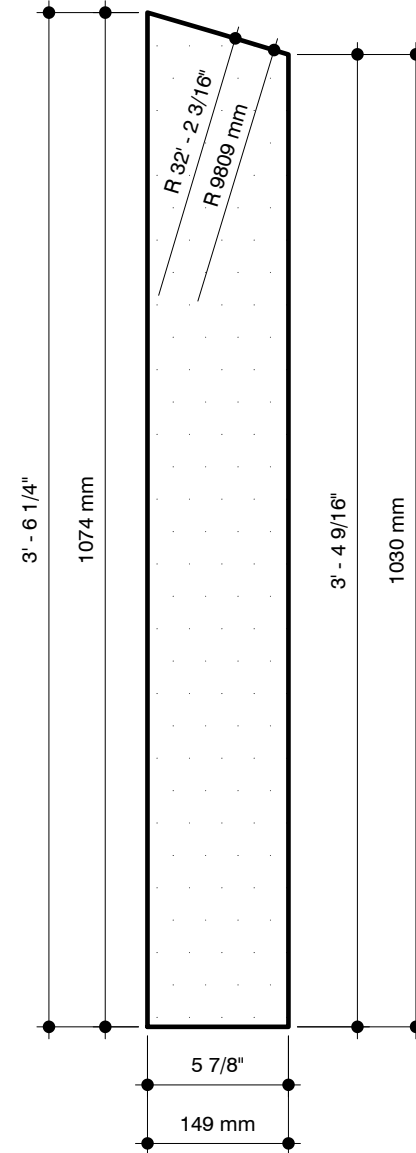

Stone Project Example

6250 Westpark Suite 218 Houston Texas 77057

Date: 02/16/09	Material: Porto Granite	Finish: Polished	Thickness: 2cm	Ticket Number: TA3
----------------	-------------------------	------------------	----------------	---------------------------

Mark	Stone Type	Quantity	Area	
			Imperial	Metric
A4	ST-1	1	1.296 SF	0.120 m ²

Abbreviations
 FE - Finished Edge QME - Quirk Mitre Edge

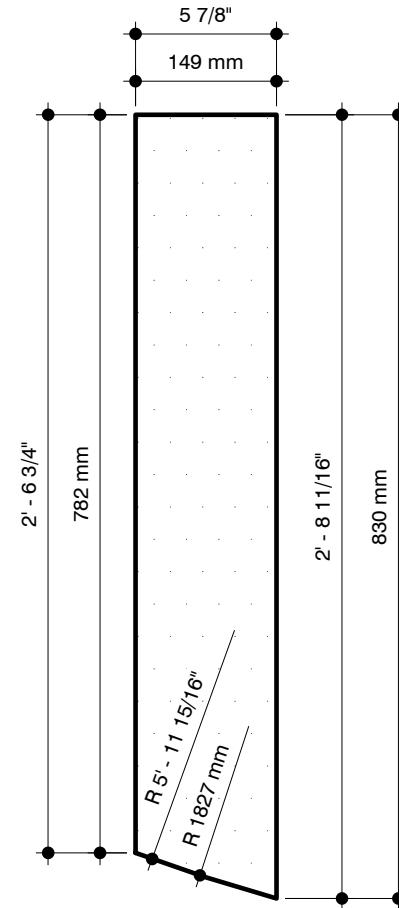

Stone Project Example

6250 Westpark Suite 218 Houston Texas 77057

Date: 02/17/09	Material: Porto Granite	Finish: Polished	Thickness: 2cm	Ticket Number: TA4
----------------	-------------------------	------------------	----------------	---------------------------

Mark	Stone Type	Quantity	Area	
			Imperial	Metric
A7	ST-1	1	7.907 SF	0.735 m ²

Abbreviations
 FE - Finished Edge QME - Quirk Mitre Edge

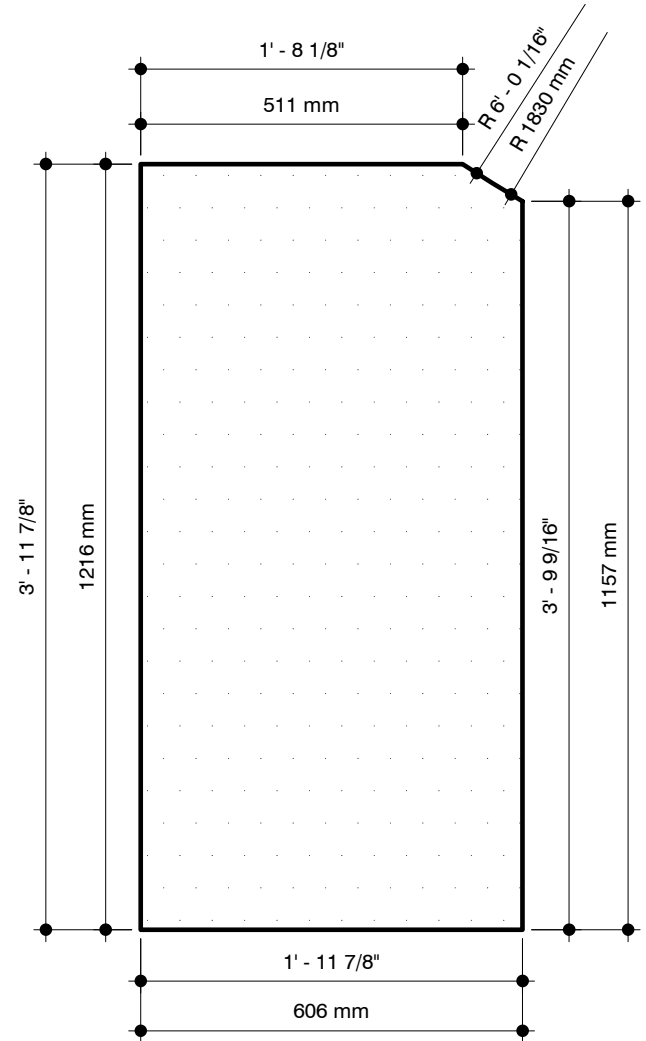

Stone Project Example

6250 Westpark Suite 218 Houston Texas 77057

Date: 02/17/09	Material: Porto Granite	Finish: Polished	Thickness: 2cm	Ticket Number: TA5
----------------	-------------------------	------------------	----------------	---------------------------

Mark	Stone Type	Quantity	Area	
			Imperial	Metric
A8	ST-1	1	7.907 SF	0.735 m ²

Abbreviations
 FE - Finished Edge QME - Quirk Mitre Edge

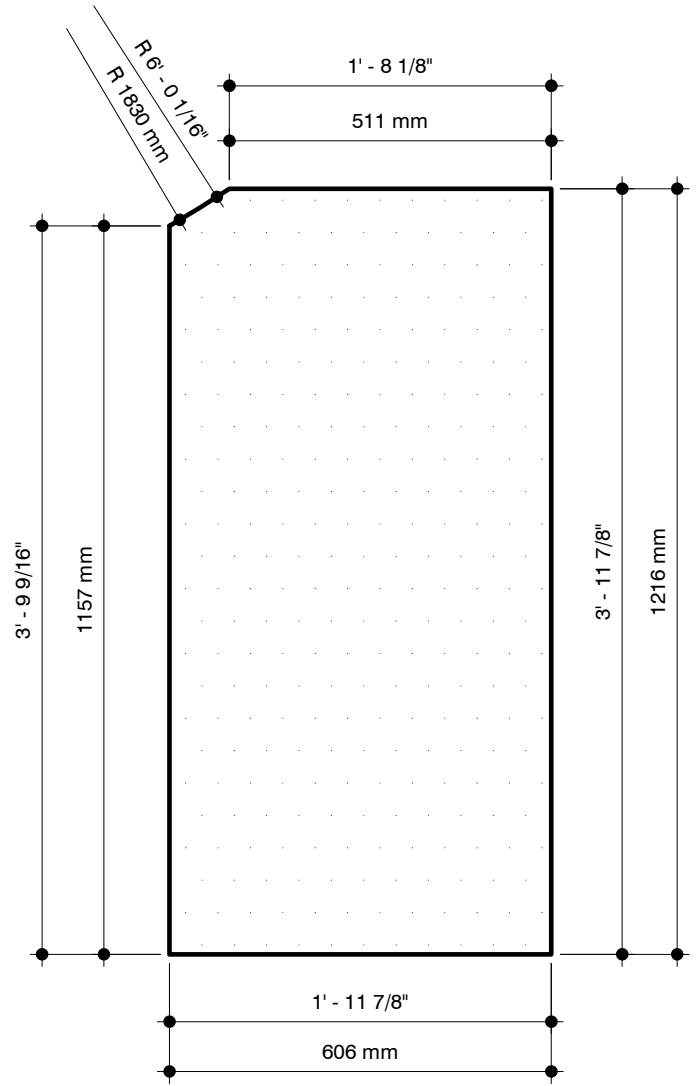

Stone Project Example

6250 Westpark Suite 218 Houston Texas 77057

Date: 02/17/09	Material: Porto Granite	Finish: Polished	Thickness: 2cm	Ticket Number: TA6
----------------	-------------------------	------------------	----------------	---------------------------

Mark	Stone Type	Quantity	Area	
			Imperial	Metric
A13	ST-1	1	6.663 SF	0.619 m ²

Abbreviations
 FE - Finished Edge QME - Quirk Mitre Edge

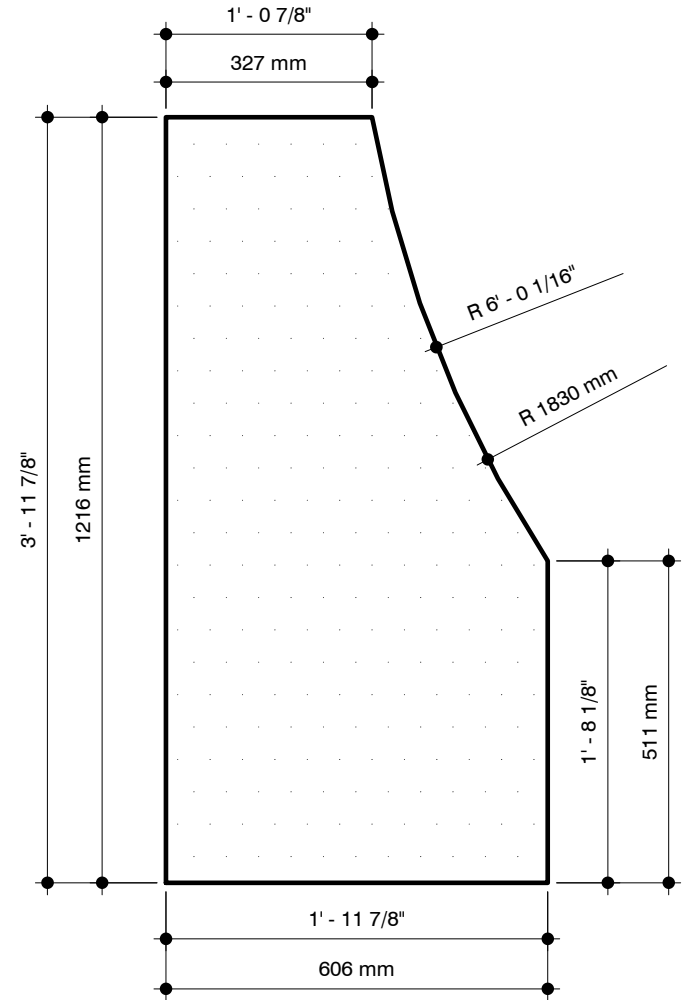

Stone Project Example

6250 Westpark Suite 218 Houston Texas 77057

Date: 02/17/09	Material: Porto Granite	Finish: Polished	Thickness: 2cm	Ticket Number: TA7
----------------	-------------------------	------------------	----------------	---------------------------

Mark	Stone Type	Quantity	Area	
			Imperial	Metric
A18	ST-1	1	6.663 SF	0.619 m ²

Abbreviations
 FE - Finished Edge QME - Quirk Mitre Edge

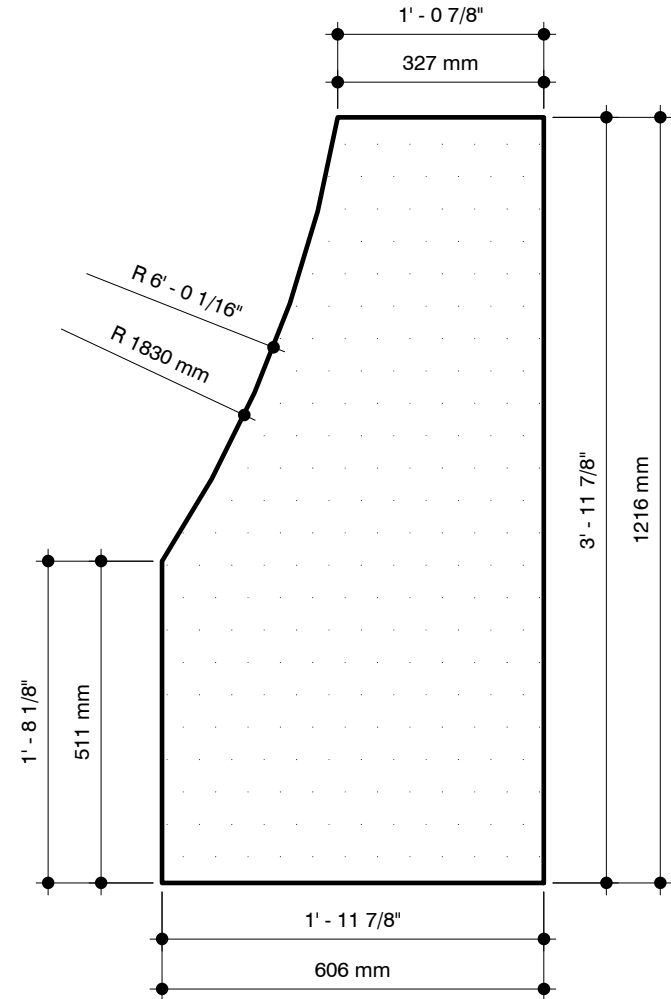

Stone Project Example

6250 Westpark Suite 218 Houston Texas 77057

Date: 02/17/09	Material: Porto Granite	Finish: Polished	Thickness: 2cm	Ticket Number: TAB
----------------	-------------------------	------------------	----------------	---------------------------

Mark	Stone Type	Quantity	Area	
			Imperial	Metric
A21	ST-1	2	2.395 SF	0.222 m ²

Abbreviations
 FE - Finished Edge QME - Quirk Mitre Edge

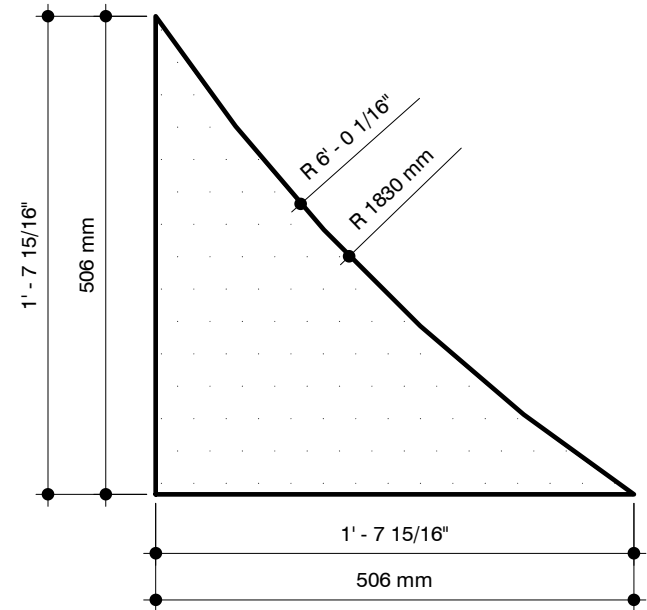

Stone Project Example

6250 Westpark Suite 218 Houston Texas 77057

Date: 02/17/09	Material: Porto Granite	Finish: Polished	Thickness: 2cm	Ticket Number: TA9
----------------	-------------------------	------------------	----------------	---------------------------

Mark	Stone Type	Quantity	Area	
			Imperial	Metric
A30	ST-1	1	7.908 SF	0.735 m ²

Abbreviations
 FE - Finished Edge QME - Quirk Mitre Edge

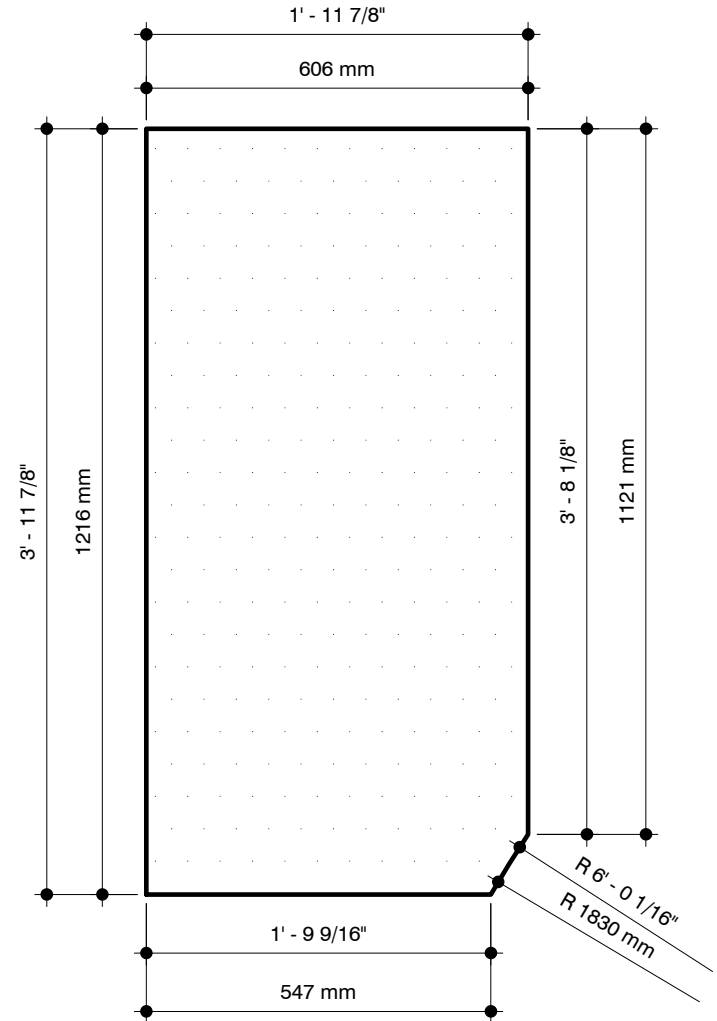

Stone Project Example

6250 Westpark Suite 218 Houston Texas 77057

Date: 02/18/09

Material: Porto Granite

Finish: Polished

Thickness: 2cm

Ticket Number: **TA10**

Mark	Stone Type	Quantity	Area	
			Imperial	Metric
A33	ST-1	1	4.751 SF	0.441 m ²

Abbreviations
 FE - Finished Edge QME - Quirk Mitre Edge

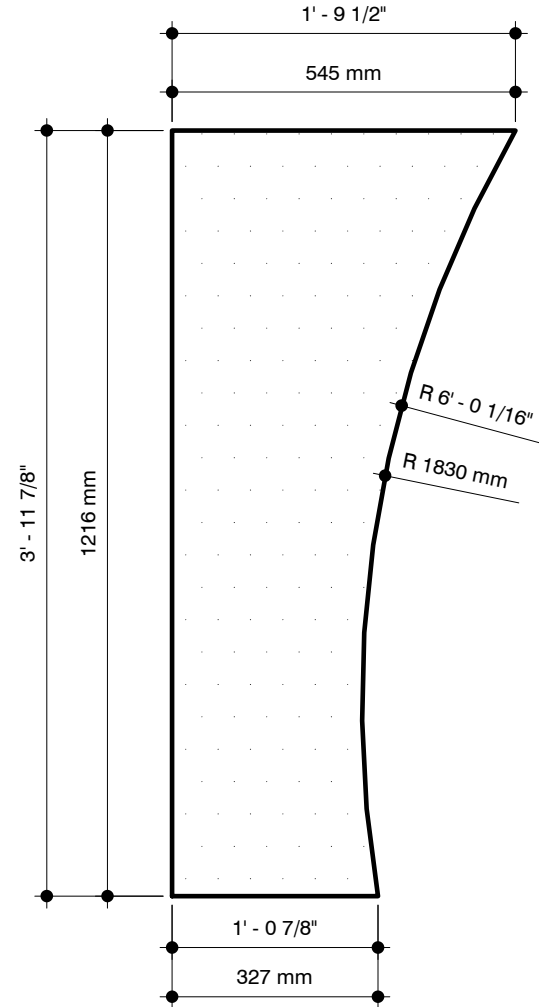

Stone Project Example

6250 Westpark Suite 218 Houston Texas 77057

Date: 02/20/09	Material: Porto Granite	Finish: Polished	Thickness: 2cm	Ticket Number: TA11
----------------	-------------------------	------------------	----------------	----------------------------

Mark	Stone Type	Quantity	Area	
			Imperial	Metric
A36	ST-1	1	4.751 SF	0.441 m ²

×

Abbreviations
 FE - Finished Edge QME - Quirk Mitre Edge

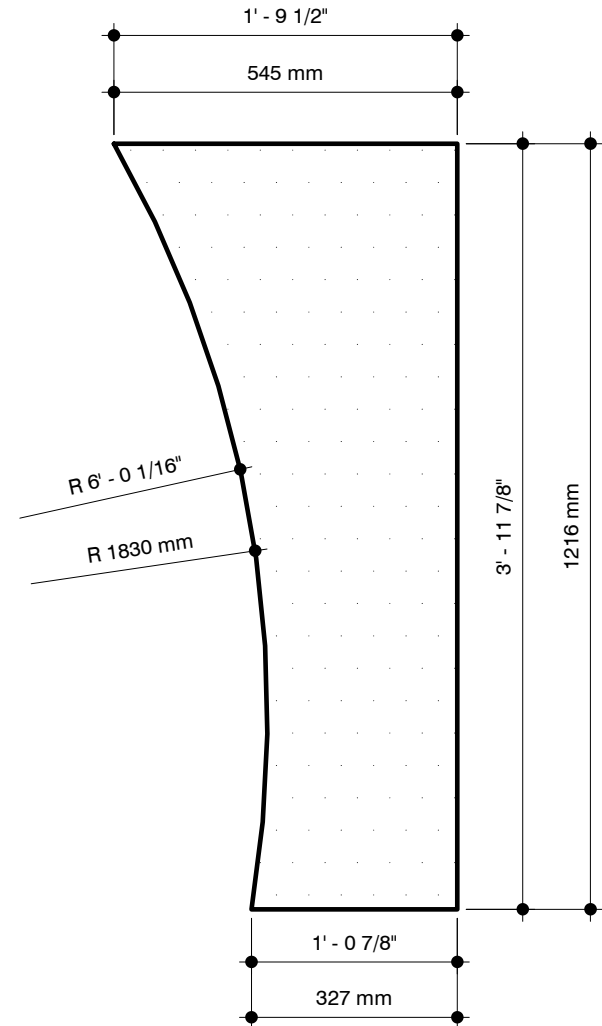

Stone Project Example

6250 Westpark Suite 218 Houston Texas 77057

Date: 02/20/09

Material: Porto Granite

Finish: Polished

Thickness: 2cm

Ticket Number: **TA12**

Mark	Stone Type	Quantity	Area	
			Imperial	Metric
A39	ST-1	1	7.906 SF	0.735 m ²

Abbreviations
 FE - Finished Edge QME - Quirk Mitre Edge

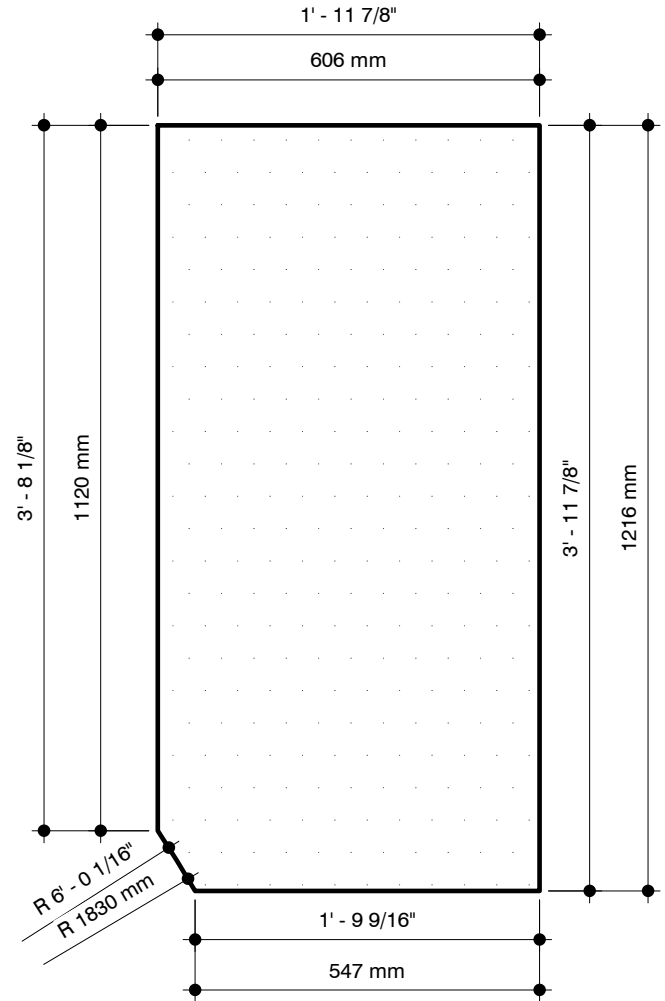

Stone Project Example

6250 Westpark Suite 218 Houston Texas 77057

Date: 02/20/09	Material: Porto Granite	Finish: Polished	Thickness: 2cm	Ticket Number: TA13
----------------	-------------------------	------------------	----------------	----------------------------

Mark	Stone Type	Quantity	Area	
			Imperial	Metric
A42	ST-1	1	5.142 SF	0.478 m ²

Abbreviations
 FE - Finished Edge QME - Quirk Mitre Edge

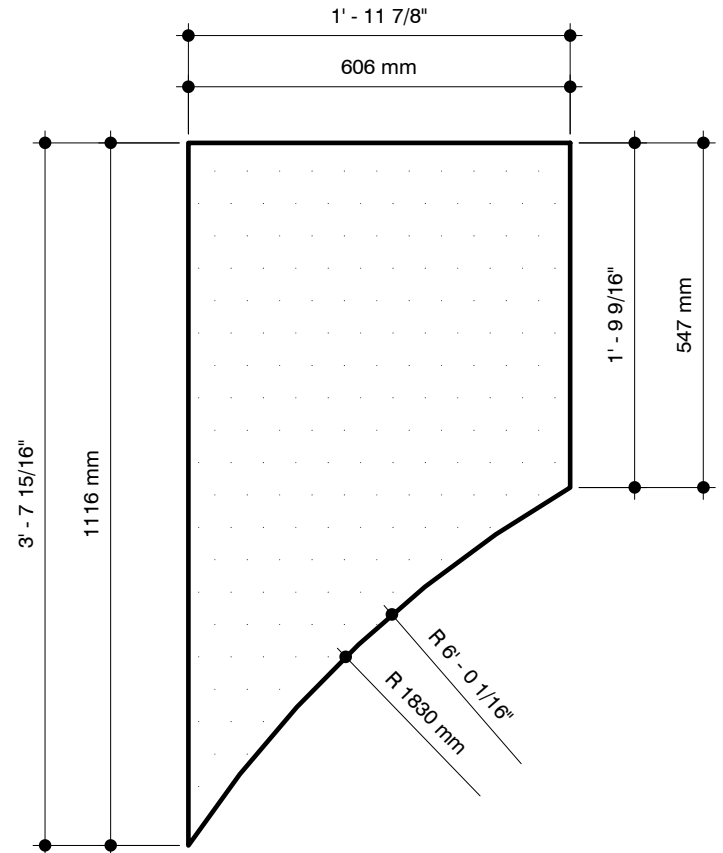

Stone Project Example

6250 Westpark Suite 218 Houston Texas 77057

Date: 02/20/09	Material: Porto Granite	Finish: Polished	Thickness: 2cm	Ticket Number: TA14
----------------	-------------------------	------------------	----------------	----------------------------

Mark	Stone Type	Quantity	Area	
			Imperial	Metric
A43	ST-1	1	5.142 SF	0.478 m ²

Abbreviations
 FE - Finished Edge QME - Quirk Mitre Edge

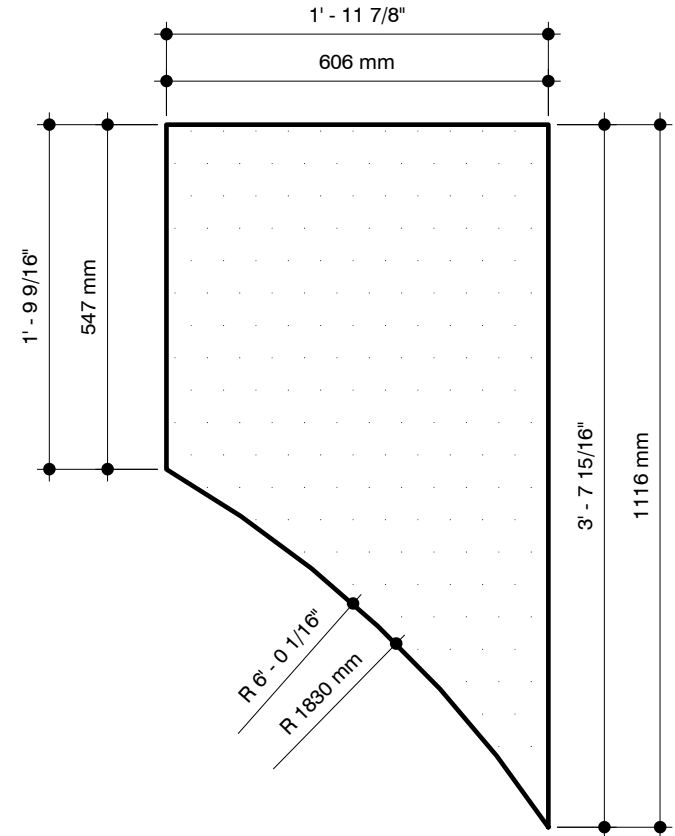

Stone Project Example

6250 Westpark Suite 218 Houston Texas 77057

Date: 02/20/09	Material: Porto Granite	Finish: Polished	Thickness: 2cm	Ticket Number: TA15
----------------	-------------------------	------------------	----------------	----------------------------

Mark	Stone Type	Quantity	Area	
			Imperial	Metric
A44	ST-1	1	2.717 SF	0.252 m ²

Abbreviations
 FE - Finished Edge QME - Quirk Mitre Edge

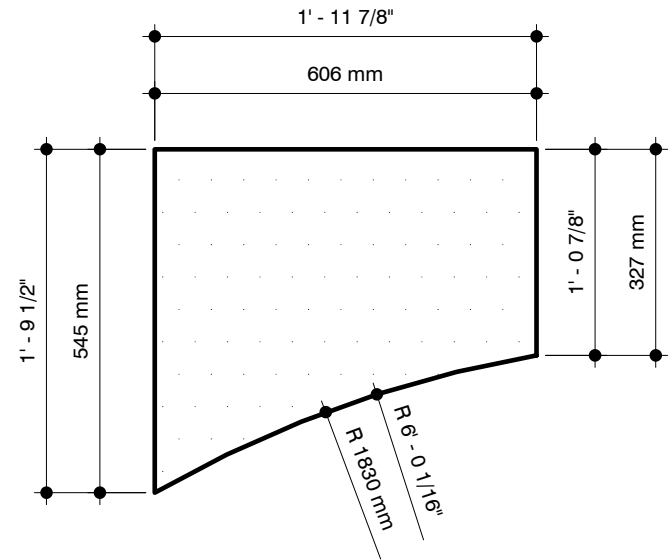

Stone Project Example

6250 Westpark Suite 218 Houston Texas 77057

Date: 02/20/09	Material: Porto Granite	Finish: Polished	Thickness: 2cm	Ticket Number: TA16
----------------	-------------------------	------------------	----------------	----------------------------

Mark	Stone Type	Quantity	Area	
			Imperial	Metric
A45	ST-1	1	2.717 SF	0.252 m ²

Abbreviations
 FE - Finished Edge QME - Quirk Mitre Edge

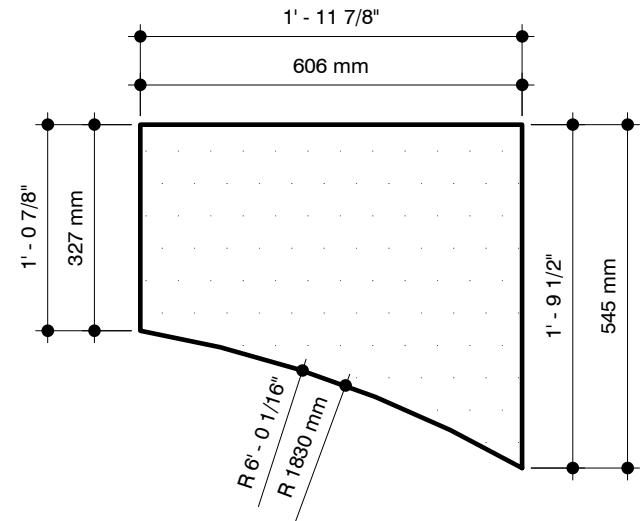

Stone Project Example

6250 Westpark Suite 218 Houston Texas 77057

Date: 02/20/09	Material: Porto Granite	Finish: Polished	Thickness: 2cm	Ticket Number: TA17
----------------	-------------------------	------------------	----------------	----------------------------

Mark	Stone Type	Quantity	Area	
			Imperial	Metric
A46	ST-1	1	2.024 SF	0.188 m ²

Abbreviations
 FE - Finished Edge QME - Quirk Mitre Edge

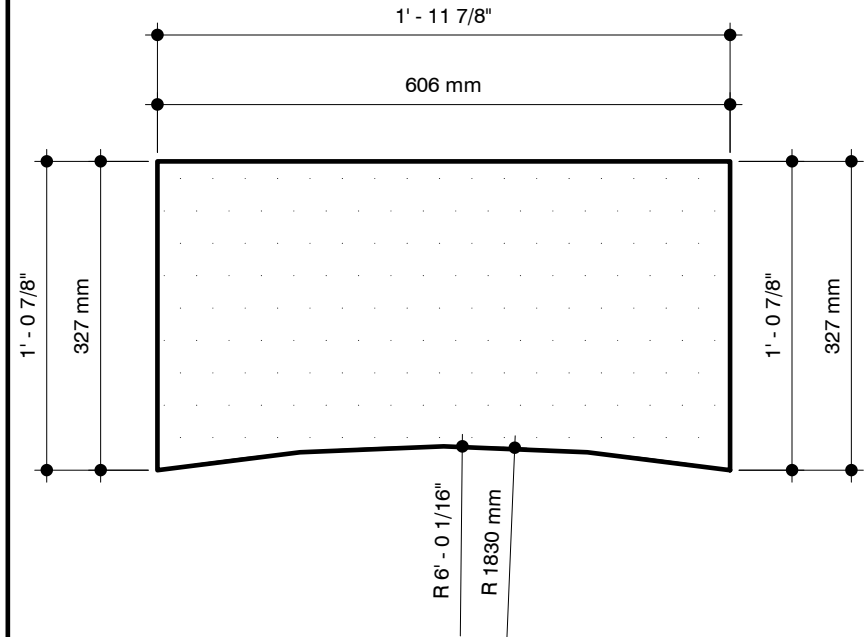

Stone Project Example

6250 Westpark Suite 218 Houston Texas 77057

Date: 02/20/09	Material: Porto Granite	Finish: Polished	Thickness: 2cm	Ticket Number: TA18
----------------	-------------------------	------------------	----------------	----------------------------

Mark	Stone Type	Quantity	Area	
			Imperial	Metric
A93	ST-1	1	6.697 SF	0.622 m ²

Abbreviations
 FE - Finished Edge QME - Quirk Mitre Edge

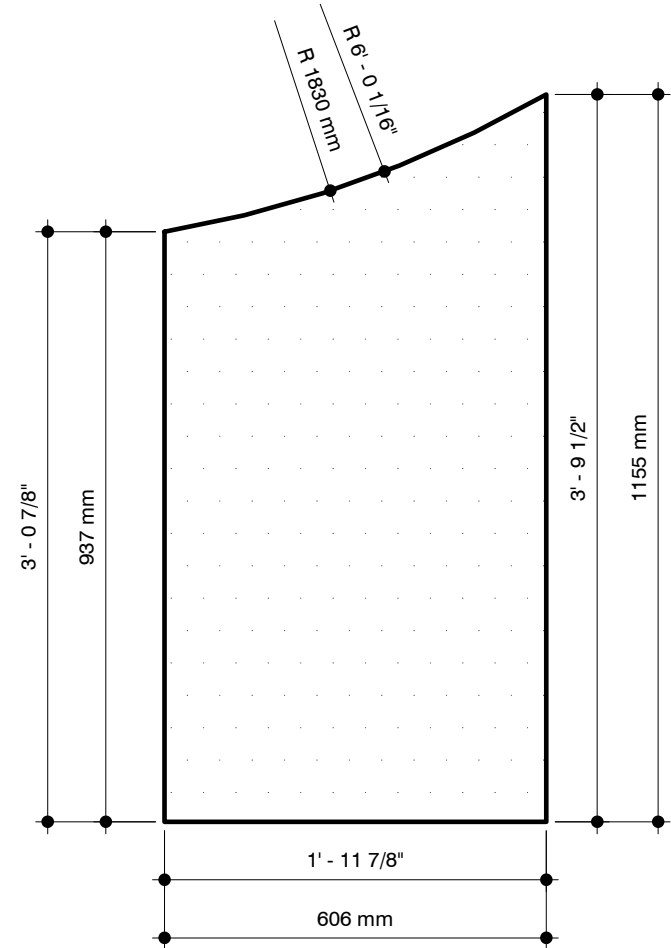

Stone Project Example

6250 Westpark Suite 218 Houston Texas 77057

Date: 02/20/09	Material: Porto Granite	Finish: Polished	Thickness: 2cm	Ticket Number: TA19
----------------	-------------------------	------------------	----------------	----------------------------

Mark	Stone Type	Quantity	Area	
			Imperial	Metric
A94	ST-1	1	6.697 SF	0.622 m ²

Abbreviations
 FE - Finished Edge QME - Quirk Mitre Edge

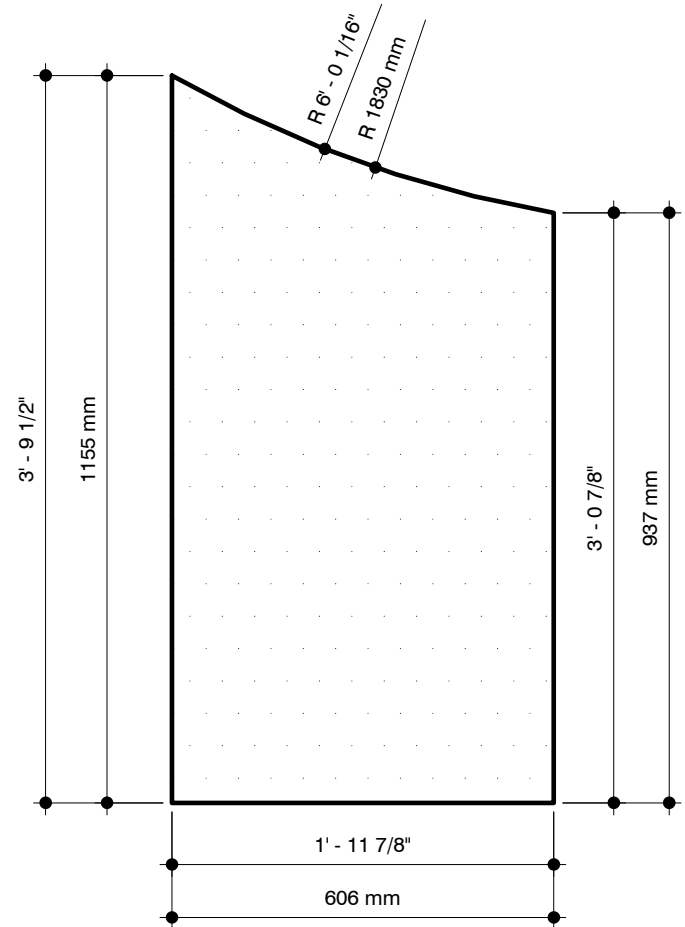

Stone Project Example

6250 Westpark Suite 218 Houston Texas 77057

Date: 02/20/09	Material: Porto Granite	Finish: Polished	Thickness: 2cm	Ticket Number: TA20
----------------	-------------------------	------------------	----------------	----------------------------

Mark	Stone Type	Quantity	Area	
			Imperial	Metric
A95	ST-1	1	6.004 SF	0.558 m ²

Abbreviations
 FE - Finished Edge QME - Quirk Mitre Edge

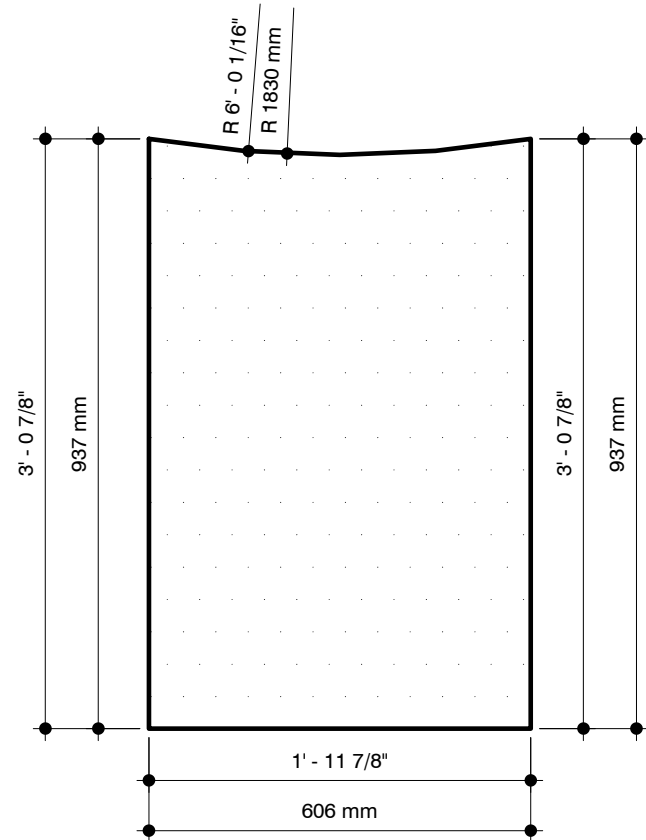

Stone Project Example

6250 Westpark Suite 218 Houston Texas 77057

Date: 02/20/09	Material: Porto Granite	Finish: Polished	Thickness: 2cm	Ticket Number: TA21
----------------	-------------------------	------------------	----------------	----------------------------

Mark	Stone Type	A		B		Quantity	Area	
		Imperial	Metric	Imperial	Metric		Imperial	Metric
A5	ST-1	3' - 11 7/8"	1216 mm	2' - 0 7/8"	632 mm	16	132.321 SF	12.293 m ²
A6	ST-1	3' - 11 7/8"	1216 mm	1' - 11 3/4"	603 mm	1	7.897 SF	0.734 m ²
A9	ST-1	2' - 6 5/16"	770 mm	2' - 0 7/8"	632 mm	22	115.198 SF	10.702 m ²
A10	ST-1	2' - 6 5/16"	770 mm	1' - 11 3/4"	603 mm	2	10.001 SF	0.929 m ²
A11	ST-1	2' - 0 7/8"	632 mm	1' - 3 7/16"	392 mm	3	8.000 SF	0.743 m ²
A14	ST-1	3' - 11 7/8"	1216 mm	2' - 4"	711 mm	1	9.309 SF	0.865 m ²
A15	ST-1	2' - 6 5/16"	770 mm	2' - 4"	711 mm	2	11.788 SF	1.095 m ²
A17	ST-1	2' - 6 5/16"	770 mm	2' - 0 7/8"	632 mm	2	10.477 SF	0.973 m ²
A19	ST-1	2' - 6 5/16"	770 mm	2' - 1 9/16"	650 mm	4	21.534 SF	2.001 m ²
A20	ST-1	3' - 11 7/8"	1216 mm	2' - 1 9/16"	650 mm	2	17.005 SF	1.580 m ²
A22	ST-1	2' - 6 5/16"	770 mm	2' - 1 1/2"	648 mm	2	10.741 SF	0.998 m ²
A23	ST-1	3' - 11 7/8"	1216 mm	2' - 1 1/2"	648 mm	1	8.482 SF	0.788 m ²
A24	ST-1	9 3/4"	248 mm	1' - 3 7/16"	392 mm	2	2.090 SF	0.194 m ²
A25	ST-1	2' - 6 5/16"	770 mm	2' - 1 11/16"	652 mm	8	43.206 SF	4.014 m ²
A26	ST-1	3' - 11 7/8"	1216 mm	2' - 1 11/16"	652 mm	4	34.119 SF	3.170 m ²
A28	ST-1	2' - 6 5/16"	770 mm	2' - 2 3/8"	669 mm	16	88.727 SF	8.243 m ²
A29	ST-1	3' - 11 7/8"	1216 mm	2' - 2 3/8"	669 mm	8	70.067 SF	6.509 m ²
A31	ST-1	2' - 6 5/16"	770 mm	2' - 2 5/16"	668 mm	8	44.258 SF	4.112 m ²
A32	ST-1	3' - 11 7/8"	1216 mm	2' - 2 5/16"	668 mm	4	34.950 SF	3.247 m ²
A34	ST-1	2' - 6 5/16"	770 mm	1' - 11 3/16"	589 mm	4	19.524 SF	1.814 m ²
A35	ST-1	3' - 11 7/8"	1216 mm	1' - 11 3/16"	589 mm	2	15.418 SF	1.432 m ²
A37	ST-1	2' - 6 5/16"	770 mm	1' - 11 7/8"	606 mm	6	30.155 SF	2.801 m ²
A38	ST-1	3' - 11 7/8"	1216 mm	1' - 11 7/8"	606 mm	116	920.763 SF	85.542 m ²
A40	ST-1	1' - 4 7/8"	429 mm	10 1/8"	257 mm	1	1.188 SF	0.110 m ²
A41	ST-1	1' - 11 3/16"	589 mm	10 1/8"	257 mm	1	1.630 SF	0.151 m ²
A47	ST-1	3' - 11 7/8"	1216 mm	1' - 9 5/16"	541 mm	8	56.685 SF	5.266 m ²
A48	ST-1	4' - 5 13/16"	1367 mm	1' - 9 5/16"	541 mm	1	7.964 SF	0.740 m ²
A49	ST-1	4' - 5 13/16"	1367 mm	1' - 11 7/8"	606 mm	13	115.986 SF	10.775 m ²
A50	ST-1	2' - 5 13/16"	757 mm	1' - 9 5/16"	541 mm	1	4.412 SF	0.410 m ²
A51	ST-1	2' - 5 13/16"	757 mm	1' - 11 7/8"	606 mm	13	64.257 SF	5.970 m ²
A52	ST-1	2' - 5 13/16"	757 mm	1' - 9 3/16"	538 mm	1	4.386 SF	0.408 m ²
A53	ST-1	3' - 11 7/8"	1216 mm	1' - 9 3/16"	538 mm	2	14.088 SF	1.309 m ²
A54	ST-1	2' - 2 9/16"	675 mm	1' - 9 3/16"	538 mm	1	3.908 SF	0.363 m ²
A55	ST-1	3' - 8 5/16"	1126 mm	1' - 11 7/8"	606 mm	8	58.776 SF	5.460 m ²
A56	ST-1	4' - 5 13/16"	1367 mm	1' - 9 3/16"	538 mm	1	7.918 SF	0.736 m ²
A57	ST-1	3' - 9 7/8"	1165 mm	1' - 11 7/8"	606 mm	1	7.606 SF	0.707 m ²
A58	ST-1	3' - 11 7/8"	1216 mm	1' - 11 11/16"	602 mm	2	15.751 SF	1.463 m ²
Grand total						290	2030.589 SF	188.648 m ²

Abbreviations
FE - Finished Edge QME - Quirk Mitre Edge

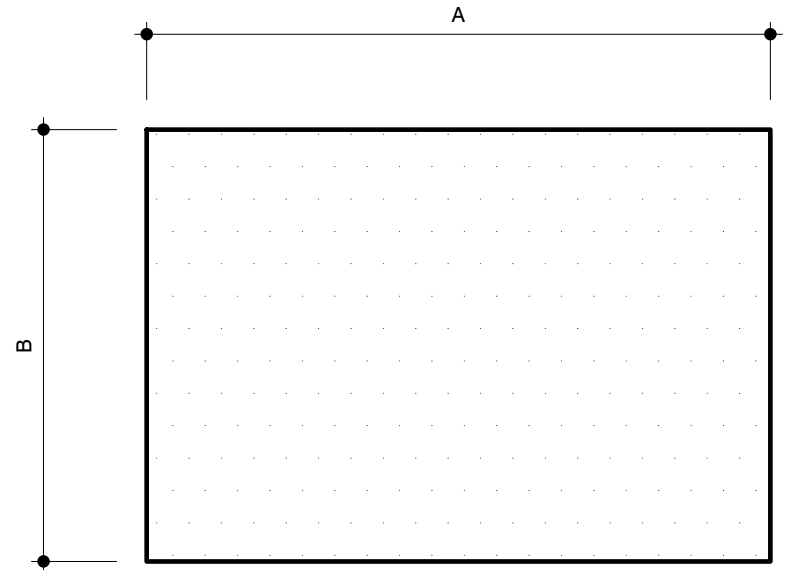

Stone Project Example

6250 Westpark Suite 218 Houston Texas 77057

Date: 02/13/09

Material: Porto Granite

Finish: Polished

Thickness: 2cm

Ticket Number: **TA22**

Mark	Stone Type	A		B		Quantity	Area	
		Imperial	Metric	Imperial	Metric		Imperial	Metric
A59	ST-1	2' - 0 5/8"	625 mm	1' - 11 7/8"	606 mm	12	48.993 SF	4.552 m ²
A60	ST-1	2' - 0 5/8"	625 mm	1' - 11 11/16"	602 mm	2	8.101 SF	0.753 m ²
A61	ST-1	2' - 0 9/16"	624 mm	1' - 11 11/16"	602 mm	2	8.081 SF	0.751 m ²
A62	ST-1	2' - 0 9/16"	624 mm	1' - 11 7/8"	606 mm	12	48.869 SF	4.540 m ²
A63	ST-1	2' - 0 9/16"	624 mm	1' - 8 13/16"	529 mm	8	28.400 SF	2.638 m ²
A64	ST-1	3' - 11 7/8"	1216 mm	1' - 8 13/16"	529 mm	16	110.711 SF	10.285 m ²
A65	ST-1	2' - 0 5/8"	625 mm	1' - 8 13/16"	529 mm	8	28.473 SF	2.645 m ²
A66	ST-1	9 1/4"	235 mm	1' - 8 13/16"	529 mm	8	10.695 SF	0.994 m ²
A67	ST-1	3' - 11 13/16"	1214 mm	1' - 11 3/4"	603 mm	1	7.886 SF	0.733 m ²
A68	ST-1	3' - 11 13/16"	1214 mm	1' - 11 7/8"	606 mm	3	23.782 SF	2.209 m ²
A69	ST-1	3' - 11 7/8"	1216 mm	2' - 6 7/8"	784 mm	4	41.059 SF	3.815 m ²
A70	ST-1	2' - 0 9/16"	624 mm	1' - 11 3/4"	603 mm	1	4.051 SF	0.376 m ²
A71	ST-1	2' - 0 5/8"	625 mm	1' - 11 3/4"	603 mm	1	4.061 SF	0.377 m ²
A72	ST-1	1' - 1 5/16"	338 mm	1' - 11 7/8"	606 mm	1	2.207 SF	0.205 m ²
A73	ST-1	1' - 9 11/16"	551 mm	1' - 11 7/8"	606 mm	2	7.192 SF	0.668 m ²
A74	ST-1	1' - 9 11/16"	551 mm	1' - 11 3/4"	603 mm	1	3.577 SF	0.332 m ²
A76	ST-1	2' - 4 5/16"	719 mm	1' - 11 7/8"	606 mm	12	56.330 SF	5.233 m ²
A77	ST-1	2' - 4 5/16"	719 mm	1' - 11 3/4"	603 mm	1	4.670 SF	0.434 m ²
A79	ST-1	3' - 11 7/8"	1216 mm	1' - 11 3/4"	603 mm	6	47.376 SF	4.401 m ²
A80	ST-1	3' - 11 7/8"	1216 mm	2' - 6"	762 mm	4	39.896 SF	3.706 m ²
A81	ST-1	2' - 8 1/4"	819 mm	1' - 11 7/8"	606 mm	1	5.347 SF	0.497 m ²
A82	ST-1	2' - 11 13/16"	910 mm	1' - 8 13/16"	529 mm	1	5.176 SF	0.481 m ²
A83	ST-1	4' - 1 7/16"	1256 mm	1' - 8 13/16"	529 mm	1	7.145 SF	0.664 m ²
A84	ST-1	2' - 4 5/16"	719 mm	2' - 6 7/8"	784 mm	2	12.141 SF	1.128 m ²
A85	ST-1	2' - 5 9/16"	751 mm	2' - 6 7/8"	784 mm	2	12.677 SF	1.178 m ²
A87	ST-1	2' - 5 9/16"	751 mm	1' - 11 7/8"	606 mm	4	19.606 SF	1.821 m ²
A88	ST-1	2' - 10 1/16"	865 mm	1' - 11 7/8"	606 mm	8	45.180 SF	4.197 m ²
A89	ST-1	2' - 10 1/16"	865 mm	1' - 11 3/4"	603 mm	1	5.618 SF	0.522 m ²
A90	ST-1	3' - 11 3/4"	1213 mm	1' - 11 3/4"	603 mm	2	15.751 SF	1.463 m ²
A91	ST-1	3' - 11 3/4"	1213 mm	1' - 11 7/8"	606 mm	6	47.501 SF	4.413 m ²
A92	ST-1	2' - 0 7/8"	632 mm	1' - 3 7/16"	392 mm	1	2.667 SF	0.248 m ²
A96	ST-1	3' - 11 7/8"	1216 mm	9 3/4"	248 mm	2	6.483 SF	0.602 m ²
Grand total						136	719.703 SF	66.863 m ²

Abbreviations
FE - Finished Edge QME - Quirk Mitre Edge

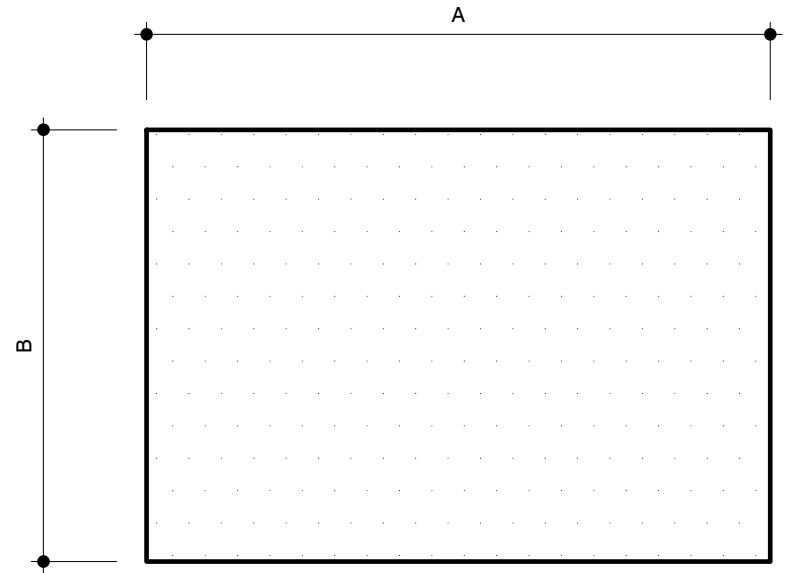

Stone Project Example

6250 Westpark Suite 218 Houston Texas 77057

Date: 02/19/09

Material: Porto Granite

Finish: Polished

Thickness: 2cm

Ticket Number: **TA23**

Mark	Stone Type	Quantity	Area	
			Imperial	Metric
B1	ST-2	1	1.625 SF	0.151 m ²

Abbreviations
 FE - Finished Edge QME - Quirk Mitre Edge

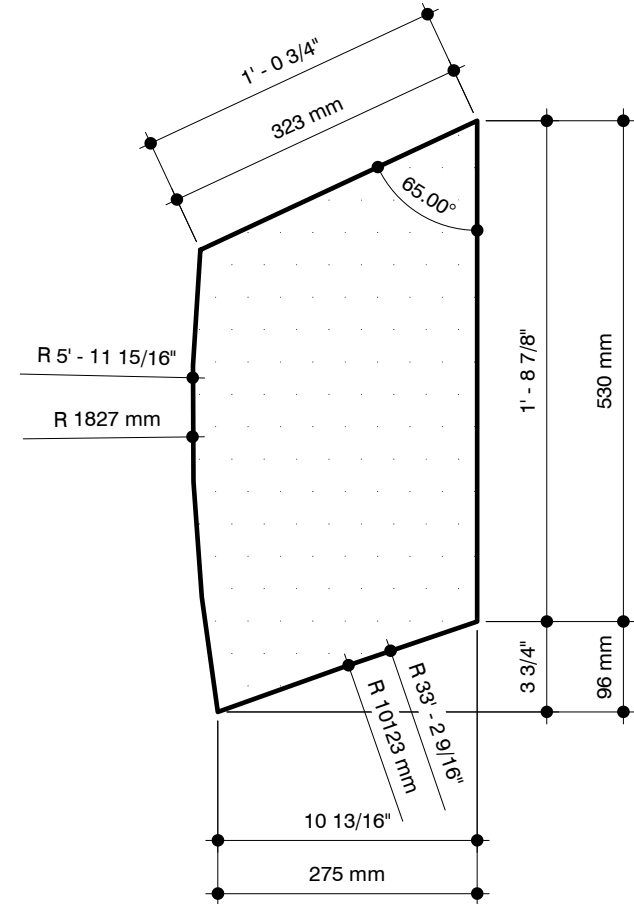

Stone Project Example

6250 Westpark Suite 218 Houston Texas 77057

Date: 02/20/09	Material: Tan Brown Granite	Finish: Polished	Thickness: 2cm	Ticket Number: TB1
----------------	-----------------------------	------------------	----------------	---------------------------

Mark	Stone Type	Quantity	Area	
			Imperial	Metric
B2	ST-2	1	1.794 SF	0.167 m ²

Abbreviations
 FE - Finished Edge QME - Quirk Mitre Edge

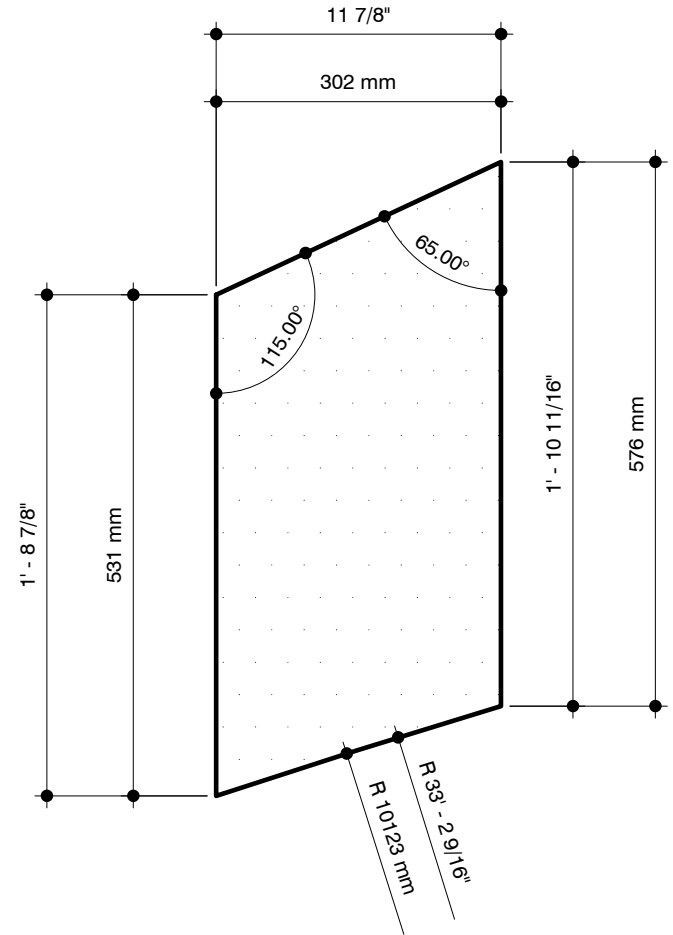

Stone Project Example

6250 Westpark Suite 218 Houston Texas 77057

Date: 02/20/09	Material: Tan Brown Granite	Finish: Polished	Thickness: 2cm	Ticket Number: TB2
----------------	-----------------------------	------------------	----------------	---------------------------

Mark	Stone Type	Quantity	Area	
			Imperial	Metric
B3	ST-2	1	1.730 SF	0.161 m ²

Abbreviations
 FE - Finished Edge QME - Quirk Mitre Edge

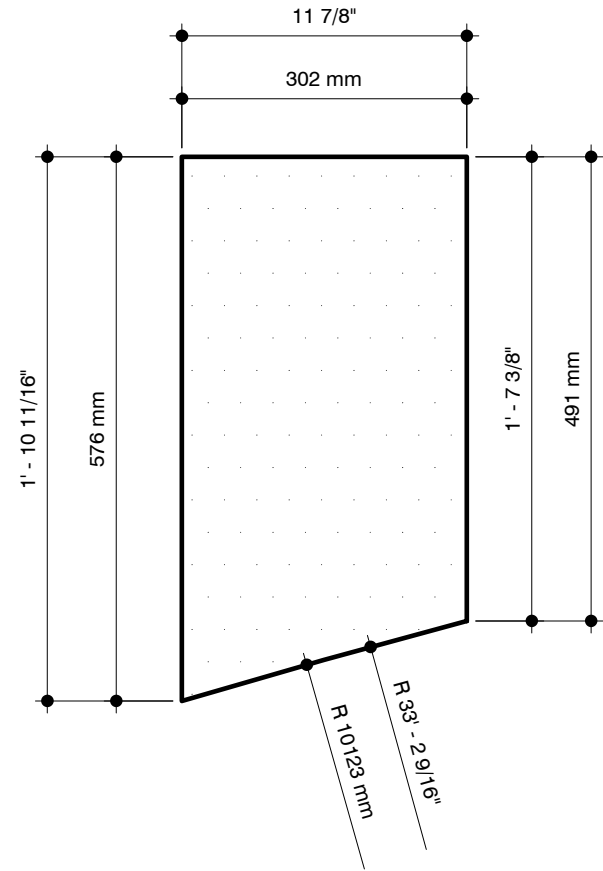

Stone Project Example

6250 Westpark Suite 218 Houston Texas 77057

Date: 02/20/09	Material: Tan Brown Granite	Finish: Polished	Thickness: 2cm	Ticket Number: TB3
----------------	-----------------------------	------------------	----------------	---------------------------

Mark	Stone Type	Quantity	Area	
			Imperial	Metric
B4	ST-2	1	0.176 SF	0.016 m ²

Abbreviations
 FE - Finished Edge QME - Quirk Mitre Edge

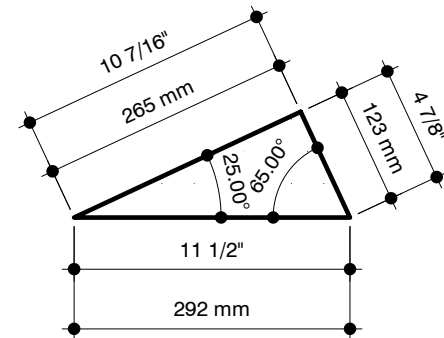

Stone Project Example

6250 Westpark Suite 218 Houston Texas 77057

Date: 02/20/09	Material: Tan Brown Granite	Finish: Polished	Thickness: 2cm	Ticket Number: TB4
----------------	-----------------------------	------------------	----------------	---------------------------

Mark	Stone Type	Quantity	Area	
			Imperial	Metric
B5	ST-2	1	0.513 SF	0.048 m ²

Abbreviations
 FE - Finished Edge QME - Quirk Mitre Edge

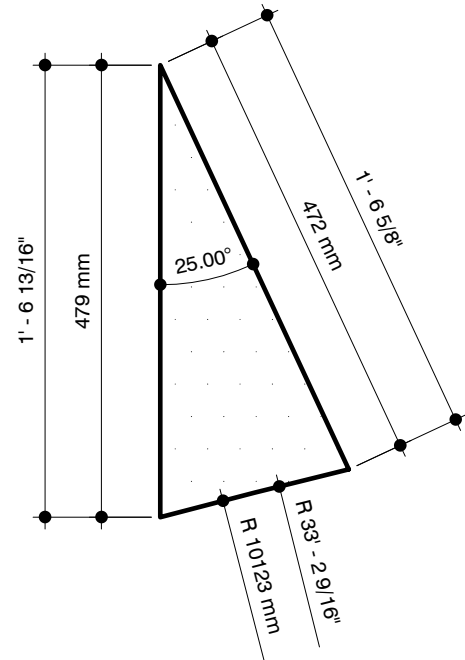

Stone Project Example

6250 Westpark Suite 218 Houston Texas 77057

Date: 02/20/09

Material: Tan Brown Granite

Finish: Polished

Thickness: 2cm

Ticket Number: **TB5**

Mark	Stone Type	Quantity	Area	
			Imperial	Metric
B6	ST-2	1	0.463 SF	0.043 m ²

Abbreviations
 FE - Finished Edge QME - Quirk Mitre Edge

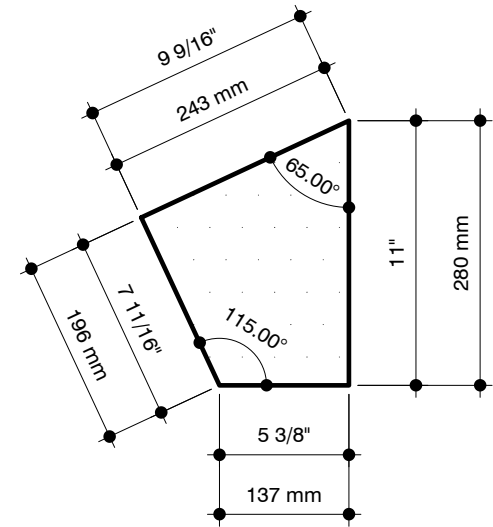

Stone Project Example

6250 Westpark Suite 218 Houston Texas 77057

Date: 02/20/09	Material: Tan Brown Granite	Finish: Polished	Thickness: 2cm	Ticket Number: TB6
----------------	-----------------------------	------------------	----------------	---------------------------

Mark	Stone Type	Quantity	Area	
			Imperial	Metric
B7	ST-2	1	1.143 SF	0.106 m ²

Abbreviations
 FE - Finished Edge QME - Quirk Mitre Edge

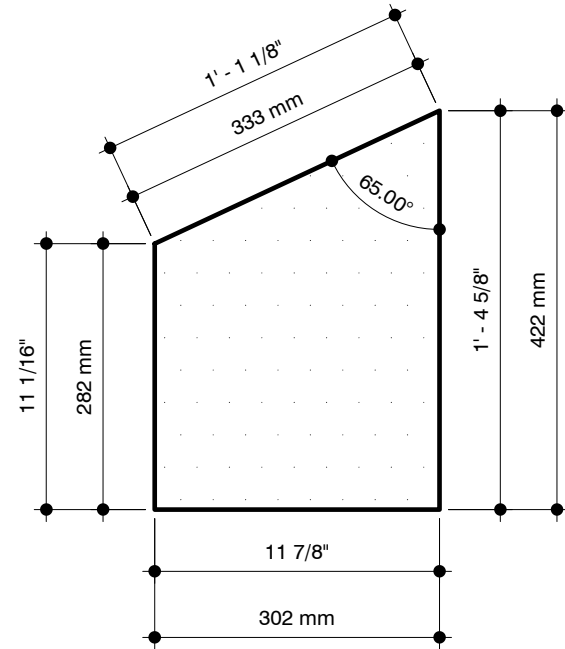

Stone Project Example

6250 Westpark Suite 218 Houston Texas 77057

Date: 02/20/09	Material: Tan Brown Granite	Finish: Polished	Thickness: 2cm	Ticket Number: TB7
----------------	-----------------------------	------------------	----------------	---------------------------

Mark	Stone Type	Quantity	Area	
			Imperial	Metric
B8	ST-2	1	1.604 SF	0.149 m ²

Abbreviations
 FE - Finished Edge QME - Quirk Mitre Edge

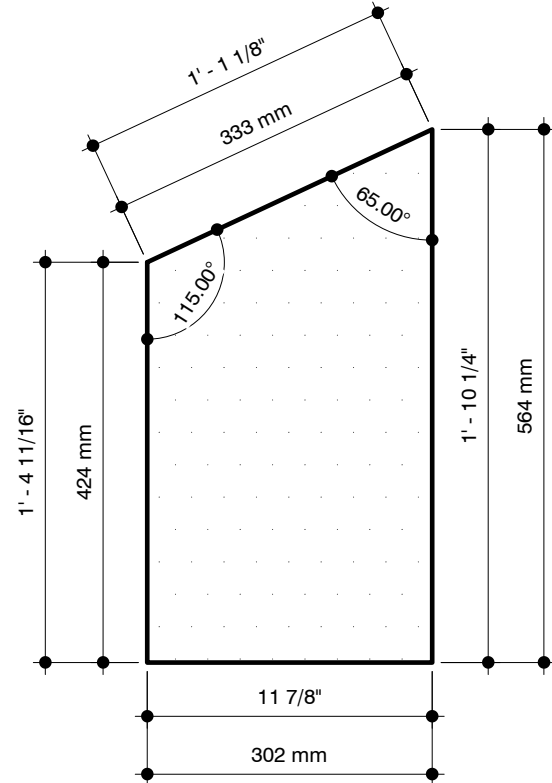

Stone Project Example

6250 Westpark Suite 218 Houston Texas 77057

Date: 02/22/09	Material: Tan Brown Granite	Finish: Polished	Thickness: 2cm	Ticket Number: TB8
----------------	-----------------------------	------------------	----------------	---------------------------

Mark	Stone Type	Quantity	Area	
			Imperial	Metric
B9	ST-2	1	2.066 SF	0.192 m ²

Abbreviations
 FE - Finished Edge QME - Quirk Mitre Edge

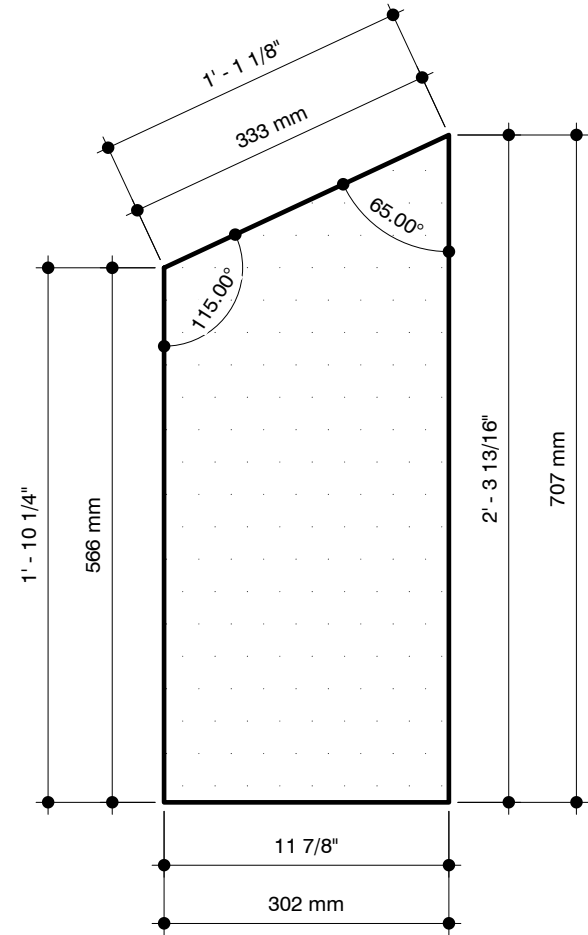

Stone Project Example

6250 Westpark Suite 218 Houston Texas 77057

Date: 02/22/09	Material: Tan Brown Granite	Finish: Polished	Thickness: 2cm	Ticket Number: TB9
----------------	-----------------------------	------------------	----------------	---------------------------

Mark	Stone Type	Quantity	Area	
			Imperial	Metric
B10	ST-2	1	2.527 SF	0.235 m ²

Abbreviations
 FE - Finished Edge QME - Quirk Mitre Edge

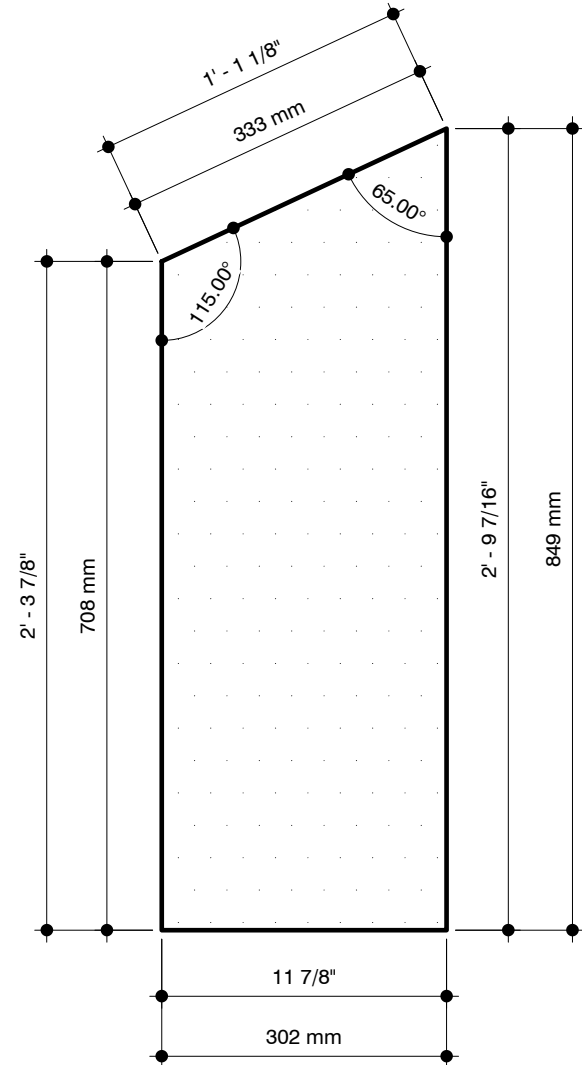

Stone Project Example

6250 Westpark Suite 218 Houston Texas 77057

Date: 02/22/09	Material: Tan Brown Granite	Finish: Polished	Thickness: 2cm	Ticket Number: TB10
----------------	-----------------------------	------------------	----------------	----------------------------

Mark	Stone Type	Quantity	Area	
			Imperial	Metric
B11	ST-2	1	2.989 SF	0.278 m ²

Abbreviations
 FE - Finished Edge QME - Quirk Mitre Edge

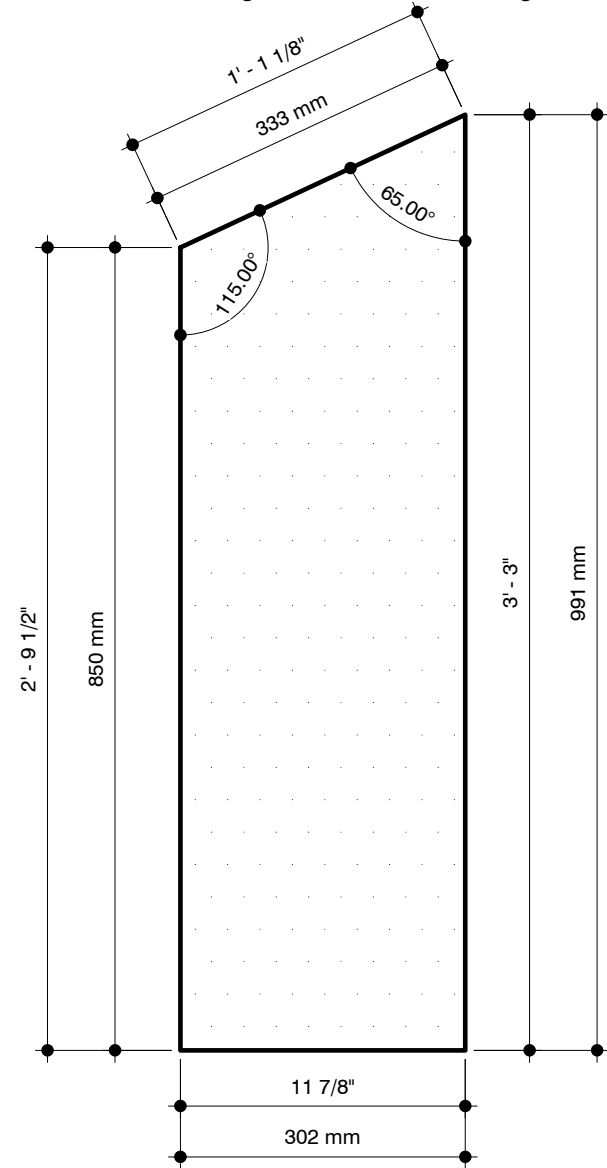

Stone Project Example

6250 Westpark Suite 218 Houston Texas 77057

Date: 02/22/09	Material: Tan Brown Granite	Finish: Polished	Thickness: 2cm	Ticket Number: TB11
----------------	-----------------------------	------------------	----------------	----------------------------

Mark	Stone Type	Quantity	Area	
			Imperial	Metric
B12	ST-2	1	3.230 SF	0.300 m ²

Abbreviations
 FE - Finished Edge QME - Quirk Mitre Edge

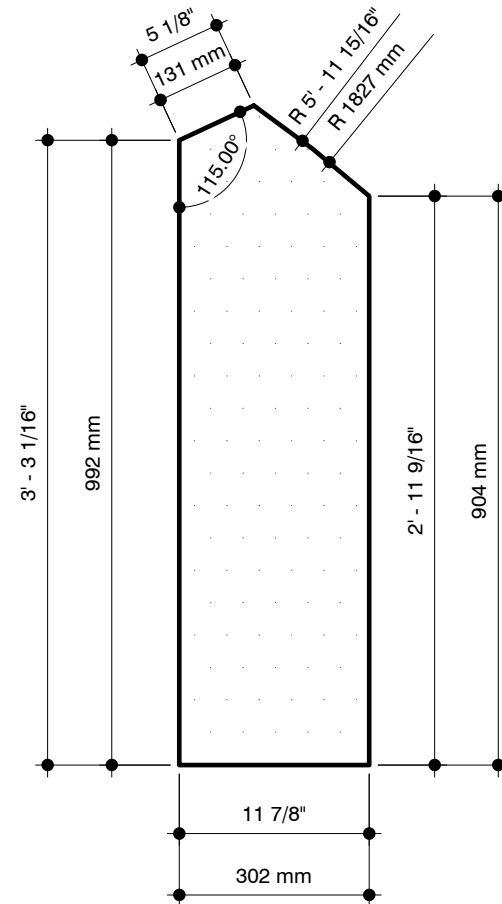

Stone Project Example +

6250 Westpark Suite 218 Houston Texas 77057

Date: 02/22/09	Material: Tan Brown Granite	Finish: Polished	Thickness: 2cm	Ticket Number: TB12
----------------	-----------------------------	------------------	----------------	----------------------------

Mark	Stone Type	Quantity	Area	
			Imperial	Metric
B13	ST-2	1	2.406 SF	0.224 m ²

Abbreviations
 FE - Finished Edge QME - Quirk Mitre Edge

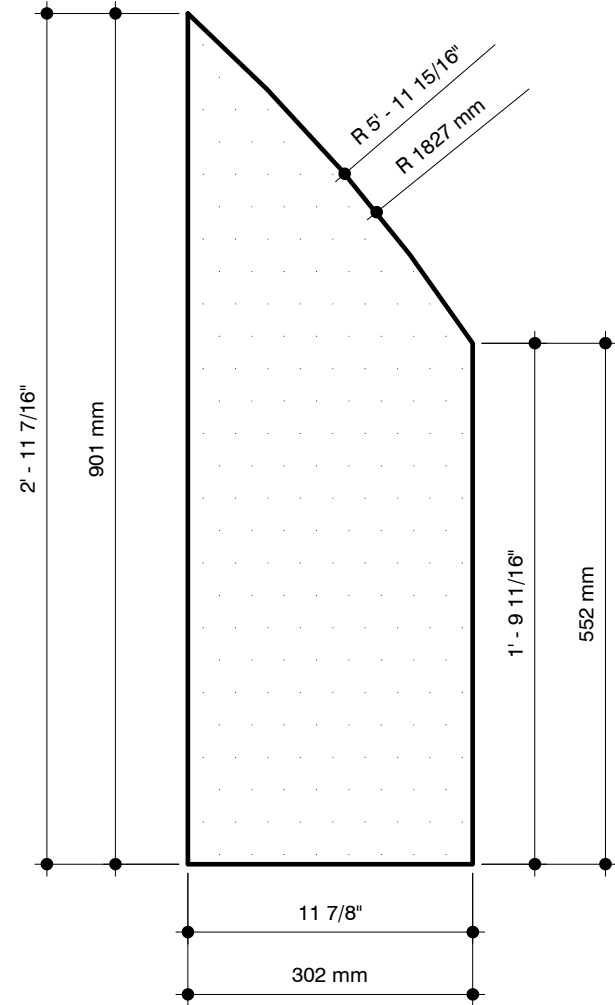

Stone Project Example

6250 Westpark Suite 218 Houston Texas 77057

Date: 02/22/09

Material: Tan Brown Granite

Finish: Polished

Thickness: 2cm

Ticket Number: **TB13**

Mark	Stone Type	Quantity	Area	
			Imperial	Metric
B14	ST-2	1	0.821 SF	0.076 m ²

Abbreviations
 FE - Finished Edge QME - Quirk Mitre Edge

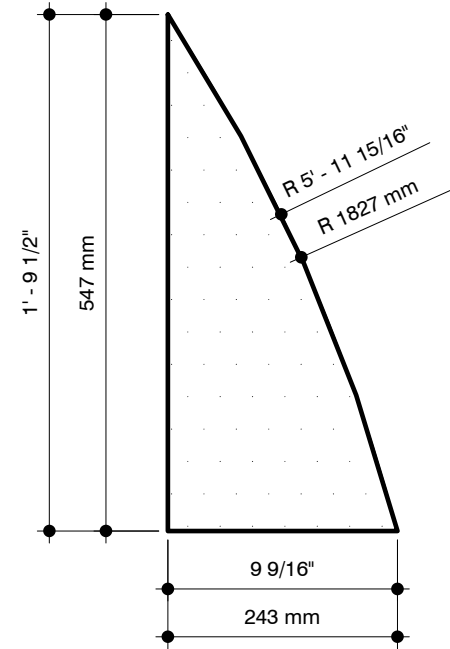

+

Stone Project Example

6250 Westpark Suite 218 Houston Texas 77057

Date: 02/22/09

Material: Tan Brown Granite

Finish: Polished

Thickness: 2cm

Ticket Number: **TB14**

Mark	Stone Type	Quantity	Area	
			Imperial	Metric
B15	ST-2	1	0.439 SF	0.041 m ²

Abbreviations
 FE - Finished Edge QME - Quirk Mitre Edge

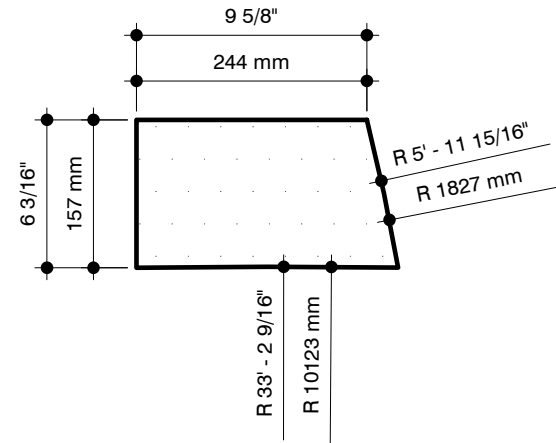

×

Stone Project Example

6250 Westpark Suite 218 Houston Texas 77057

Date: 02/22/09	Material: Tan Brown Granite	Finish: Polished	Thickness: 2cm	Ticket Number: TB15
----------------	-----------------------------	------------------	----------------	----------------------------

Mark	Stone Type	Quantity	Area	
			Imperial	Metric
B16	ST-2	1	0.521 SF	0.048 m ²

Abbreviations
 FE - Finished Edge QME - Quirk Mitre Edge

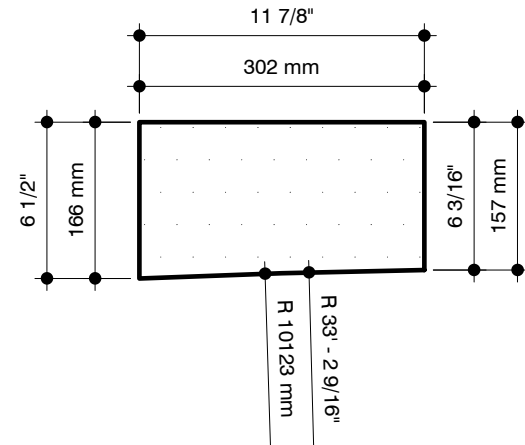

Stone Project Example

6250 Westpark Suite 218 Houston Texas 77057

Date: 02/22/09	Material: Tan Brown Granite	Finish: Polished	Thickness: 2cm	Ticket Number: TB16
----------------	-----------------------------	------------------	----------------	----------------------------

Mark	Stone Type	Quantity	Area	
			Imperial	Metric
B17	ST-2	1	0.565 SF	0.052 m ²

Abbreviations
 FE - Finished Edge QME - Quirk Mitre Edge

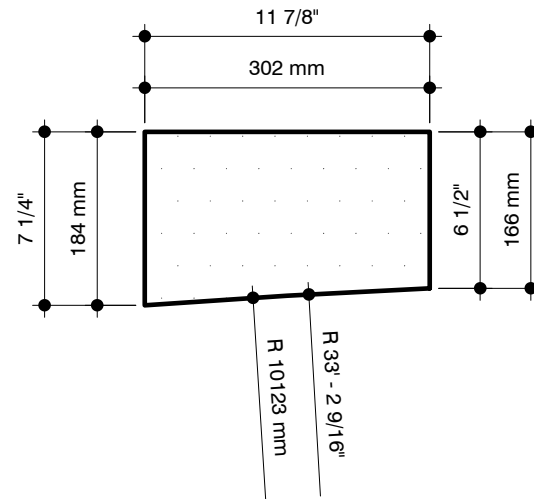

Stone Project Example

6250 Westpark Suite 218 Houston Texas 77057

Date: 02/22/09	Material: Tan Brown Granite	Finish: Polished	Thickness: 2cm	Ticket Number: TB17
----------------	-----------------------------	------------------	----------------	----------------------------

Mark	Stone Type	Quantity	Area	
			Imperial	Metric
B18	ST-2	1	0.639 SF	0.059 m ²

Abbreviations
 FE - Finished Edge QME - Quirk Mitre Edge

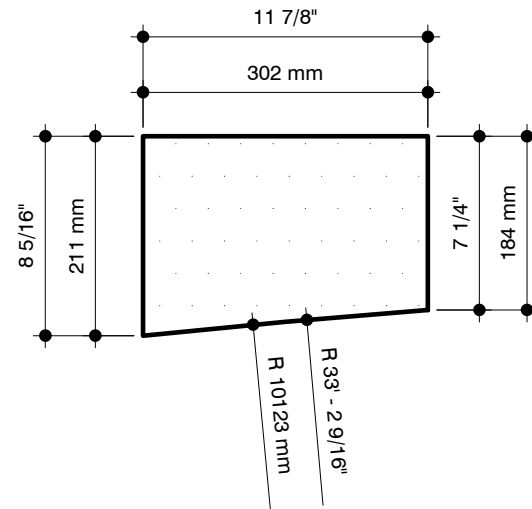

Stone Project Example

6250 Westpark Suite 218 Houston Texas 77057

Date: 02/22/09	Material: Tan Brown Granite	Finish: Polished	Thickness: 2cm	Ticket Number: TB18
----------------	-----------------------------	------------------	----------------	----------------------------

Mark	Stone Type	Quantity	Area	
			Imperial	Metric
B19	ST-2	1	0.743 SF	0.069 m ²

Abbreviations
 FE - Finished Edge QME - Quirk Mitre Edge

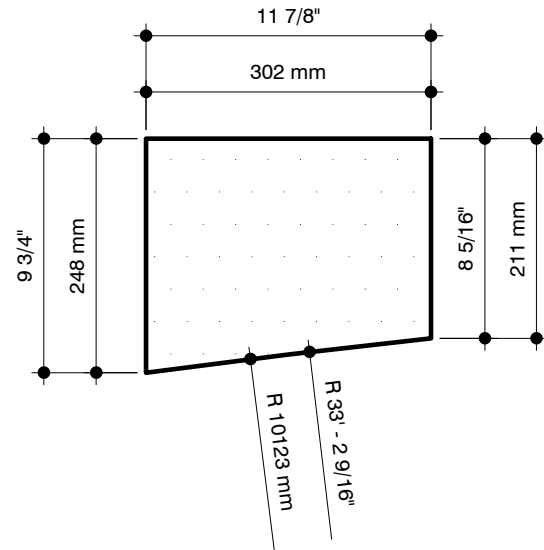

Stone Project Example

6250 Westpark Suite 218 Houston Texas 77057

Date: 02/22/09	Material: Tan Brown Granite	Finish: Polished	Thickness: 2cm	Ticket Number: TB19
----------------	-----------------------------	------------------	----------------	----------------------------

Mark	Stone Type	Quantity	Area	
			Imperial	Metric
B20	ST-2	1	0.878 SF	0.082 m ²

Abbreviations
 FE - Finished Edge QME - Quirk Mitre Edge

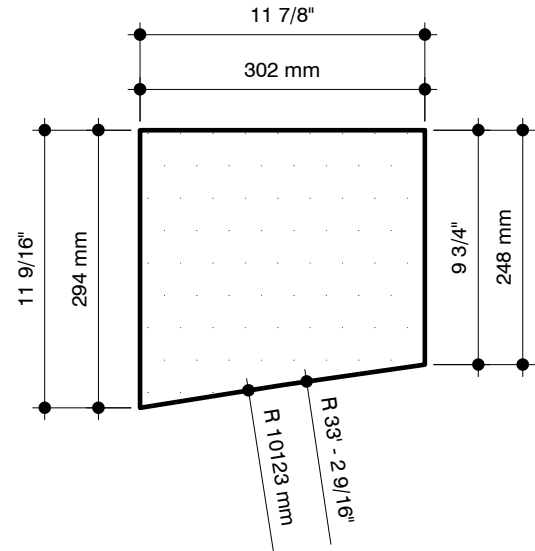

Stone Project Example

6250 Westpark Suite 218 Houston Texas 77057

Date: 02/22/09	Material: Tan Brown Granite	Finish: Polished	Thickness: 2cm	Ticket Number: TB20
----------------	-----------------------------	------------------	----------------	----------------------------

Mark	Stone Type	Quantity	Area	
			Imperial	Metric
B21	ST-2	1	1.043 SF	0.097 m ²

Abbreviations
 FE - Finished Edge QME - Quirk Mitre Edge

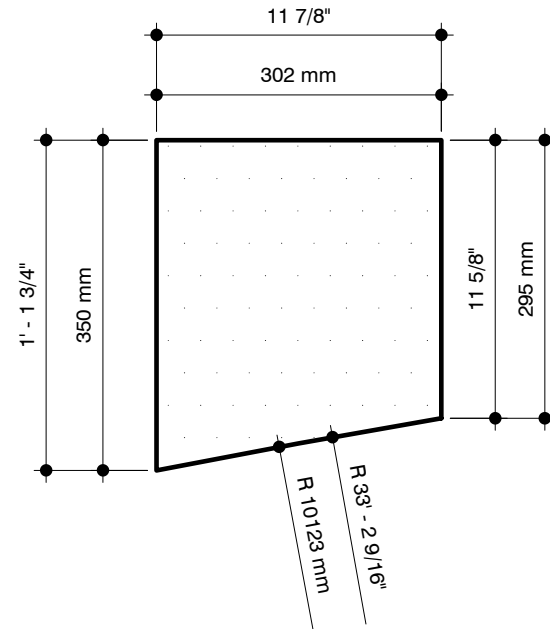

Stone Project Example

6250 Westpark Suite 218 Houston Texas 77057

Date: 02/22/09	Material: Tan Brown Granite	Finish: Polished	Thickness: 2cm	Ticket Number: TB21
----------------	-----------------------------	------------------	----------------	----------------------------

Mark	Stone Type	Quantity	Area	
			Imperial	Metric
B22	ST-2	1	1.209 SF	0.112 m ²

Abbreviations
 FE - Finished Edge QME - Quirk Mitre Edge

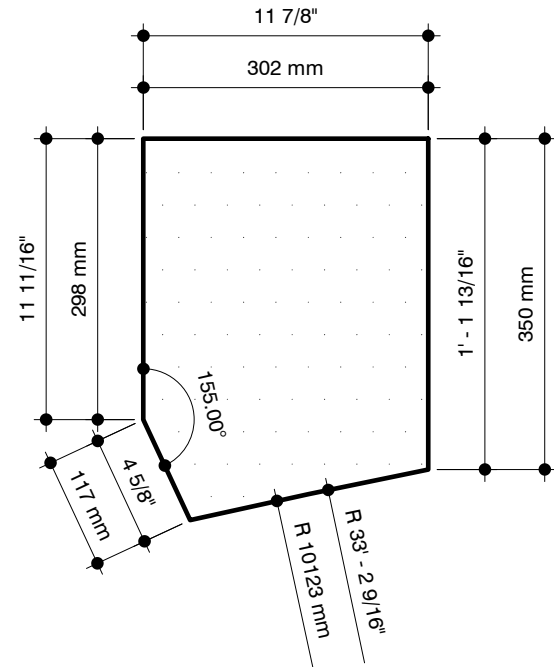

Stone Project Example

6250 Westpark Suite 218 Houston Texas 77057

Date: 02/22/09	Material: Tan Brown Granite	Finish: Polished	Thickness: 2cm	Ticket Number: TB22
----------------	-----------------------------	------------------	----------------	----------------------------

Mark	Stone Type	Quantity	Area	
			Imperial	Metric
B23	ST-2	1	0.212 SF	0.020 m ²

Abbreviations
 FE - Finished Edge QME - Quirk Mitre Edge

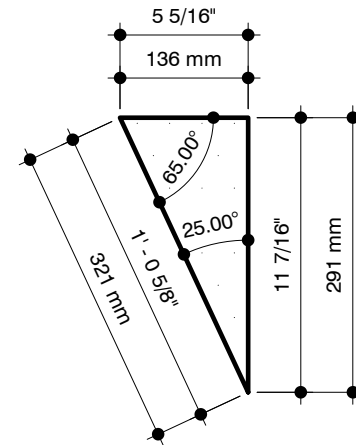

Stone Project Example

6250 Westpark Suite 218 Houston Texas 77057

Date: 02/22/09	Material: Tan Brown Granite	Finish: Polished	Thickness: 2cm	Ticket Number: TB23
----------------	-----------------------------	------------------	----------------	----------------------------

Mark	Stone Type	Quantity	Area	
			Imperial	Metric
B24	ST-2	1	0.646 SF	0.060 m ²

Abbreviations
 FE - Finished Edge QME - Quirk Mitre Edge

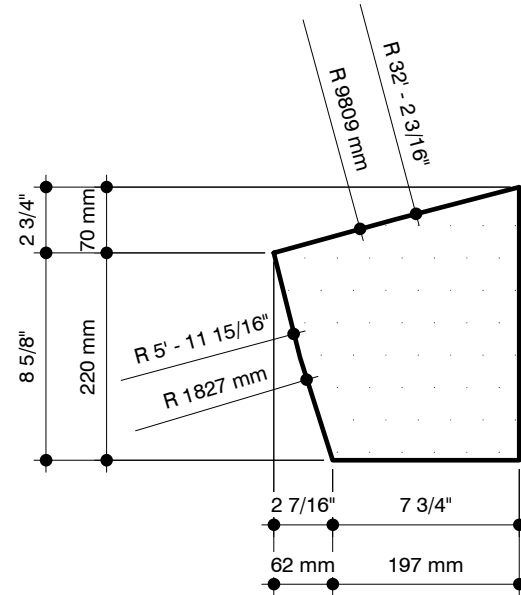

Stone Project Example

6250 Westpark Suite 218 Houston Texas 77057

Date: 02/22/09	Material: Tan Brown Granite	Finish: Polished	Thickness: 2cm	Ticket Number: TB24
----------------	-----------------------------	------------------	----------------	----------------------------

Mark	Stone Type	Quantity	Area	
			Imperial	Metric
B25	ST-2	1	1.060 SF	0.099 m ²

Abbreviations
 FE - Finished Edge QME - Quirk Mitre Edge

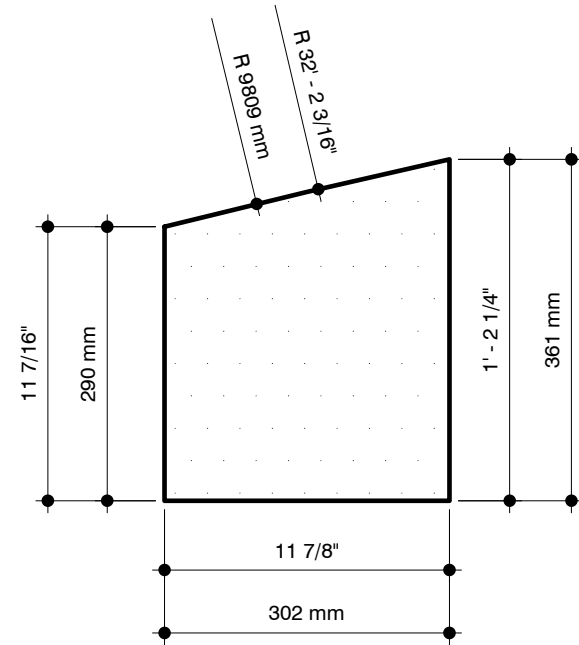

Stone Project Example

6250 Westpark Suite 218 Houston Texas 77057

Date: 02/22/09	Material: Tan Brown Granite	Finish: Polished	Thickness: 2cm	Ticket Number: TB25
----------------	-----------------------------	------------------	----------------	----------------------------

Mark	Stone Type	Quantity	Area	
			Imperial	Metric
B26	ST-2	1	1.278 SF	0.119 m ²

Abbreviations
 FE - Finished Edge QME - Quirk Mitre Edge

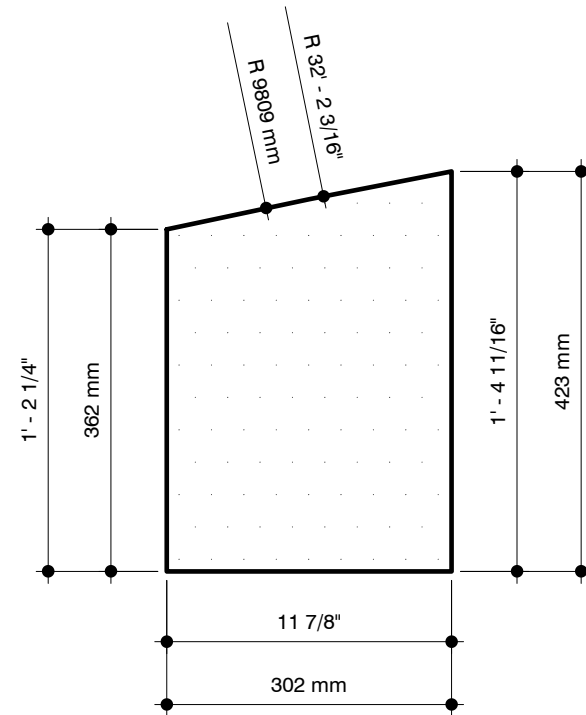

Stone Project Example

6250 Westpark Suite 218 Houston Texas 77057

Date: 02/22/09	Material: Tan Brown Granite	Finish: Polished	Thickness: 2cm	Ticket Number: TB26
----------------	-----------------------------	------------------	----------------	----------------------------

Mark	Stone Type	Quantity	Area	
			Imperial	Metric
B27	ST-2	1	1.451 SF	0.135 m ²

Abbreviations
 FE - Finished Edge QME - Quirk Mitre Edge

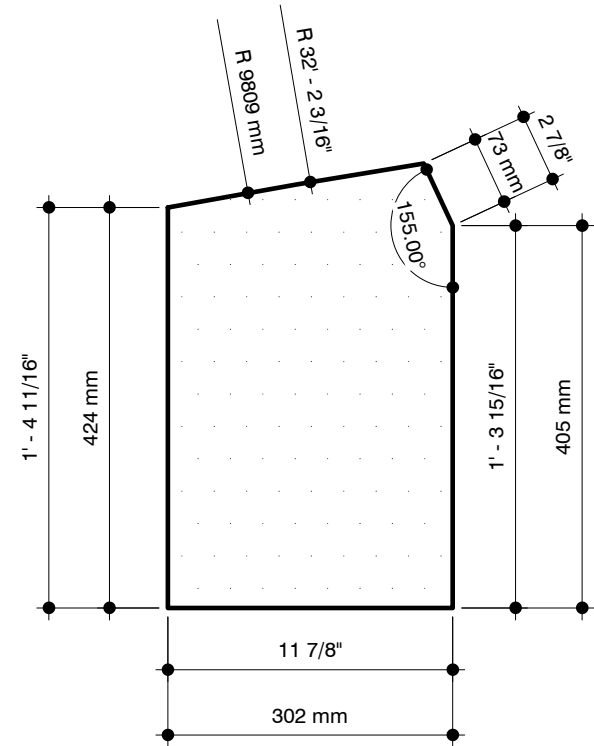

Stone Project Example

6250 Westpark Suite 218 Houston Texas 77057

Date: 02/22/09

Material: Tan Brown Granite

Finish: Polished

Thickness: 2cm

Ticket Number: **TB27**

Mark	Stone Type	Quantity	Area	
			Imperial	Metric
B28	ST-2	1	0.397 SF	0.037 m ²

Abbreviations
 FE - Finished Edge QME - Quirk Mitre Edge

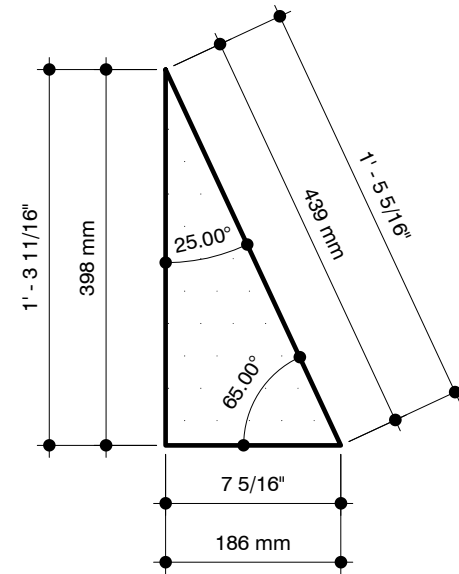

Stone Project Example

6250 Westpark Suite 218 Houston Texas 77057

Date: 02/22/09

Material: Tan Brown Granite

Finish: Polished

Thickness: 2cm

Ticket Number: **TB28**

Mark	Stone Type	Quantity	Area	
			Imperial	Metric
B29	ST-2	1	0.376 SF	0.035 m ²

Abbreviations
 FE - Finished Edge QME - Quirk Mitre Edge

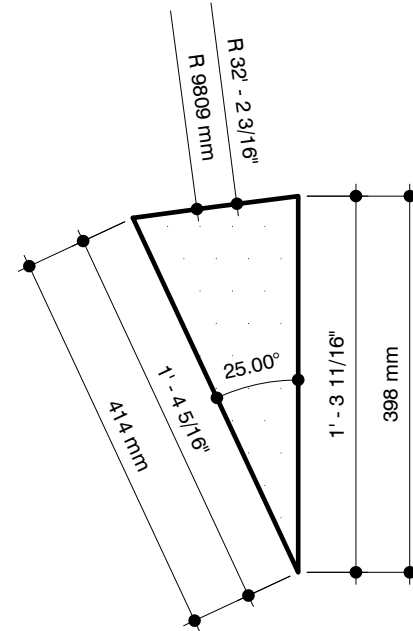

Stone Project Example

6250 Westpark Suite 218 Houston Texas 77057

Date: 02/22/09	Material: Tan Brown Granite	Finish: Polished	Thickness: 2cm	Ticket Number: TB29
----------------	-----------------------------	------------------	----------------	----------------------------

Mark	Stone Type	Quantity	Area	
			Imperial	Metric
B30	ST-2	1	1.705 SF	0.158 m ²

Abbreviations
 FE - Finished Edge QME - Quirk Mitre Edge

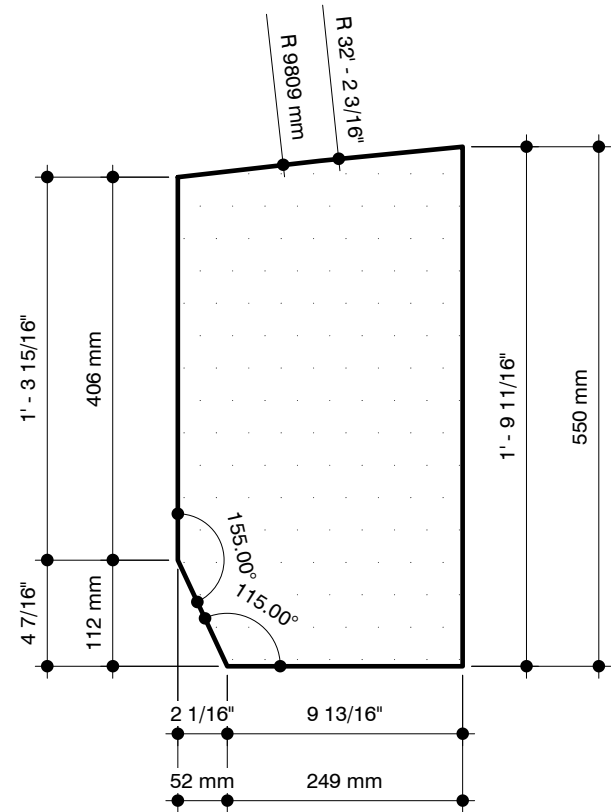

Stone Project Example

6250 Westpark Suite 218 Houston Texas 77057

Date: 02/22/09

Material: Tan Brown Granite

Finish: Polished

Thickness: 2cm

Ticket Number: **TB30**

Mark	Stone Type	Quantity	Area	
			Imperial	Metric
B31	ST-2	1	1.826 SF	0.170 m ²

Abbreviations
 FE - Finished Edge QME - Quirk Mitre Edge

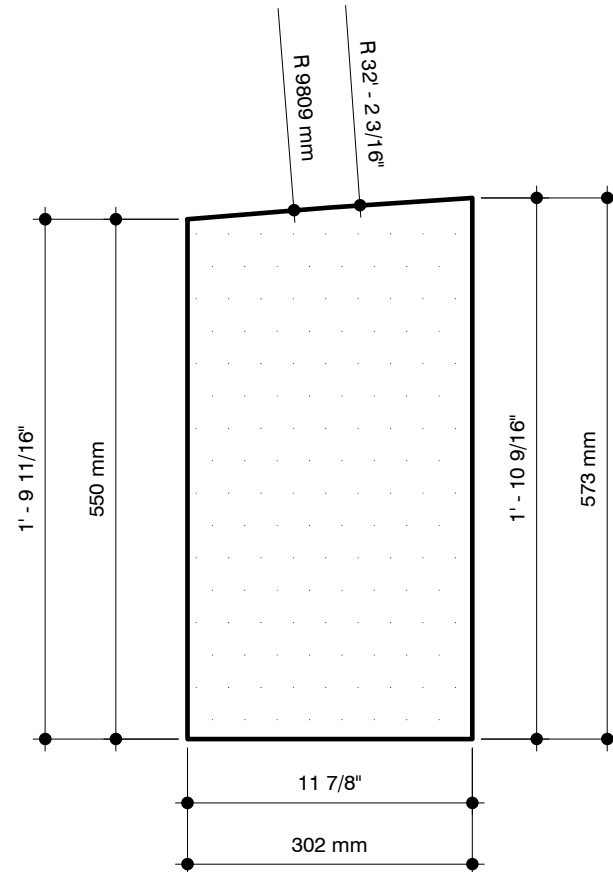

Stone Project Example

6250 Westpark Suite 218 Houston Texas 77057

Date: 02/22/09	Material: Tan Brown Granite	Finish: Polished	Thickness: 2cm	Ticket Number: TB31
----------------	-----------------------------	------------------	----------------	----------------------------

Mark	Stone Type	Quantity	Area	
			Imperial	Metric
B32	ST-2	1	1.885 SF	0.175 m ²

Abbreviations
 FE - Finished Edge QME - Quirk Mitre Edge

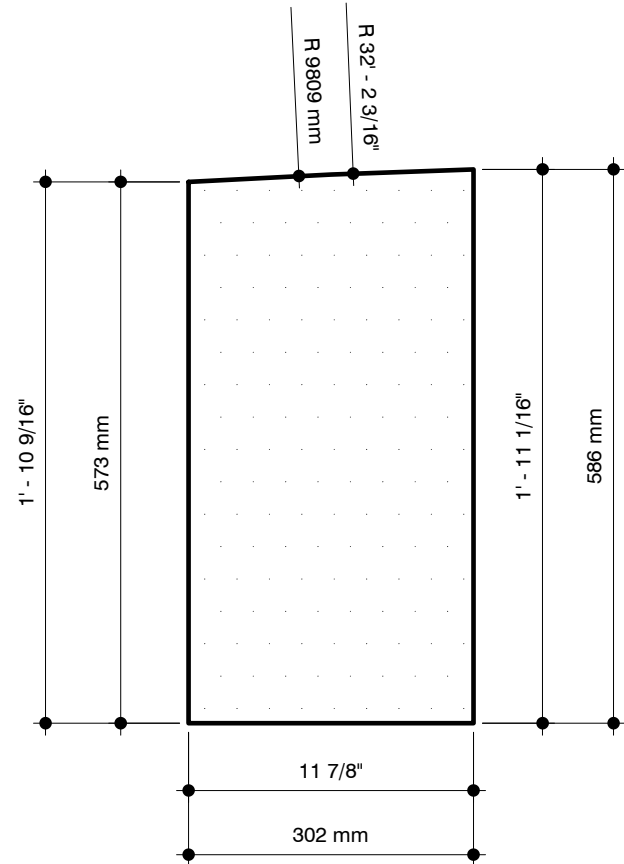

Stone Project Example

6250 Westpark Suite 218 Houston Texas 77057

Date: 02/22/09	Material: Tan Brown Granite	Finish: Polished	Thickness: 2cm	Ticket Number: TB32
----------------	-----------------------------	------------------	----------------	----------------------------

Mark	Stone Type	Quantity	Area	
			Imperial	Metric
B33	ST-2	1	1.912 SF	0.178 m ²

Abbreviations
 FE - Finished Edge QME - Quirk Mitre Edge

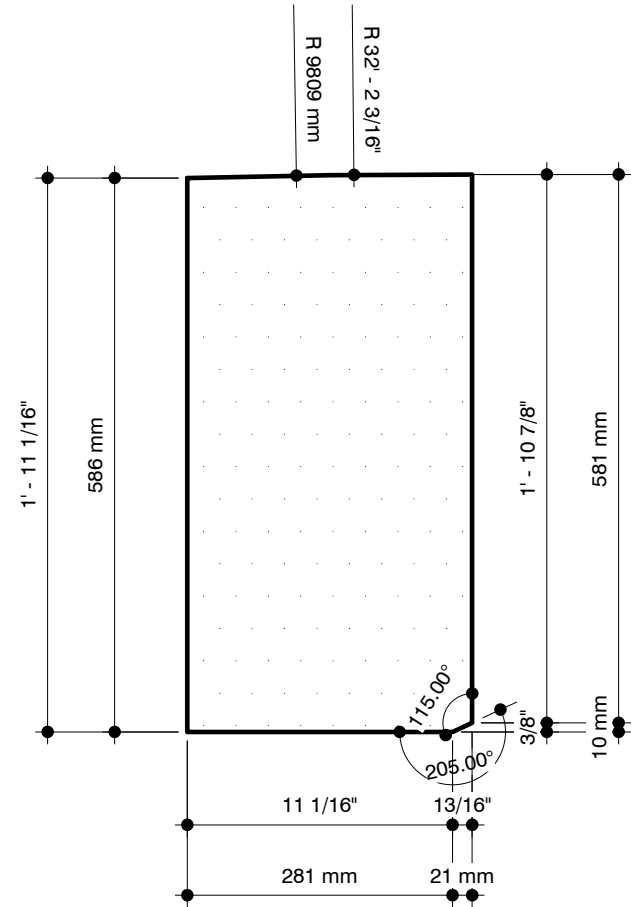

Stone Project Example

6250 Westpark Suite 218 Houston Texas 77057

Date: 02/22/09

Material: Tan Brown Granite

Finish: Polished

Thickness: 2cm

Ticket Number: **TB33**

Mark	Stone Type	Quantity	Area	
			Imperial	Metric
B34	ST-2	1	1.645 SF	0.153 m ²

Abbreviations
 FE - Finished Edge QME - Quirk Mitre Edge

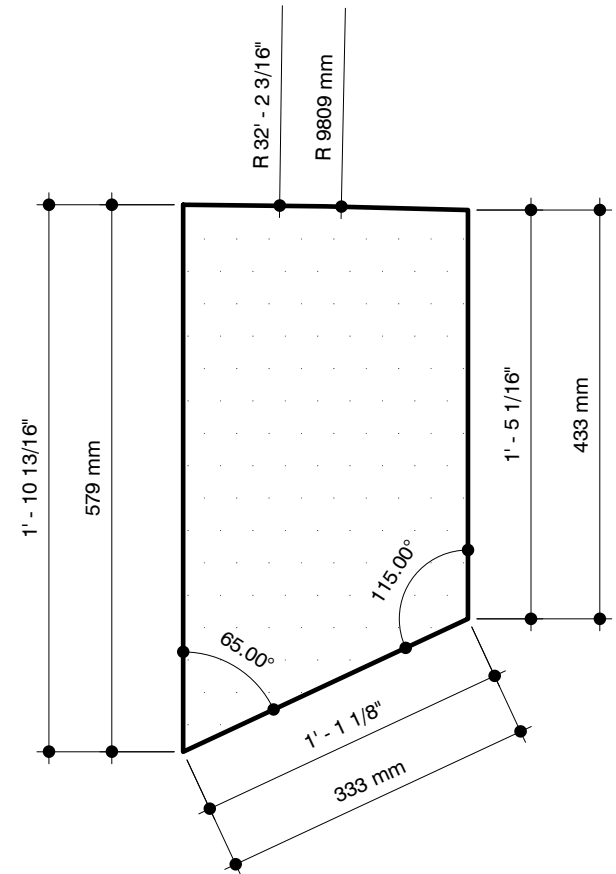

Stone Project Example

6250 Westpark Suite 218 Houston Texas 77057

Date: 02/22/09	Material: Tan Brown Granite	Finish: Polished	Thickness: 2cm	Ticket Number: TB34
----------------	-----------------------------	------------------	----------------	----------------------------

Mark	Stone Type	Quantity	Area	
			Imperial	Metric
B35	ST-2	1	1.150 SF	0.107 m ²

Abbreviations
 FE - Finished Edge QME - Quirk Mitre Edge

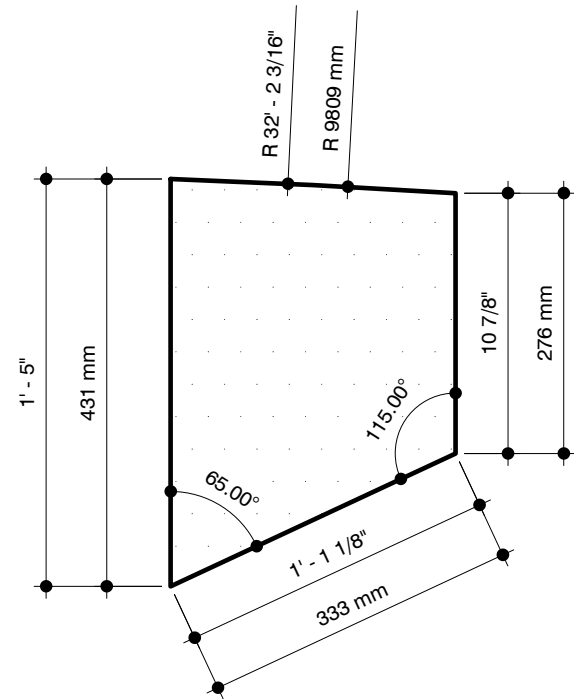

Stone Project Example

6250 Westpark Suite 218 Houston Texas 77057

Date: 02/22/09	Material: Tan Brown Granite	Finish: Polished	Thickness: 2cm	Ticket Number: TB35
----------------	-----------------------------	------------------	----------------	----------------------------

Mark	Stone Type	Quantity	Area	
			Imperial	Metric
B36	ST-2	1	0.619 SF	0.058 m ²

Abbreviations
 FE - Finished Edge QME - Quirk Mitre Edge

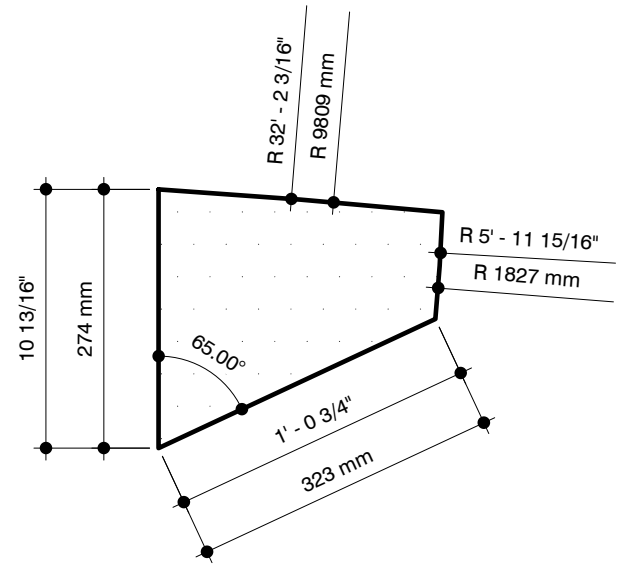

Stone Project Example

6250 Westpark Suite 218 Houston Texas 77057

Date: 02/22/09	Material: Tan Brown Granite	Finish: Polished	Thickness: 2cm	Ticket Number: TB36
----------------	-----------------------------	------------------	----------------	----------------------------

Mark	Stone Type	Quantity	Area	
			Imperial	Metric
B37	ST-2	1	0.648 SF	0.060 m ²

Abbreviations
 FE - Finished Edge QME - Quirk Mitre Edge

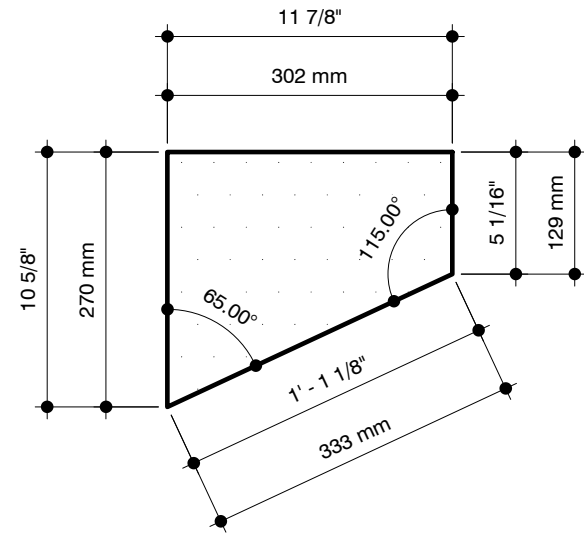

Stone Project Example

6250 Westpark Suite 218 Houston Texas 77057

Date: 02/22/09

Material: Tan Brown Granite

Finish: Polished

Thickness: 2cm

Ticket Number: **TB37**

Mark	Stone Type	Quantity	Area	
			Imperial	Metric
B38	ST-2	1	0.680 SF	0.063 m ²

Abbreviations
 FE - Finished Edge QME - Quirk Mitre Edge

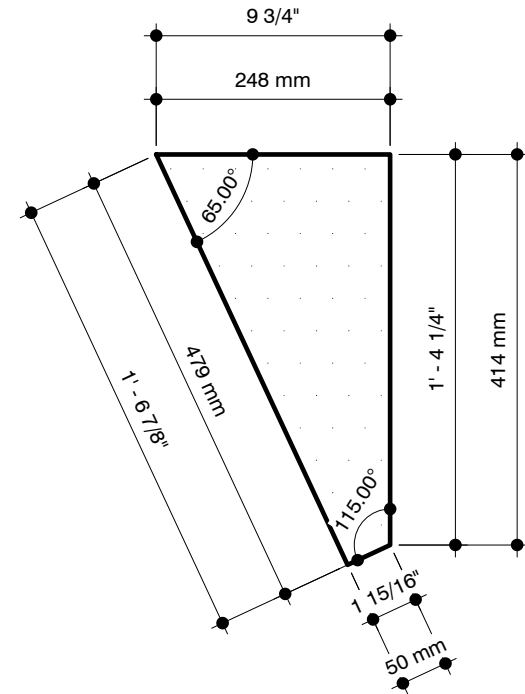

Stone Project Example

6250 Westpark Suite 218 Houston Texas 77057

Date: 02/22/09	Material: Tan Brown Granite	Finish: Polished	Thickness: 2cm	Ticket Number: TB38
----------------	-----------------------------	------------------	----------------	----------------------------

Mark	Stone Type	Quantity	Area	
			Imperial	Metric
B39	ST-2	1	1.881 SF	0.175 m ²

Abbreviations
 FE - Finished Edge QME - Quirk Mitre Edge

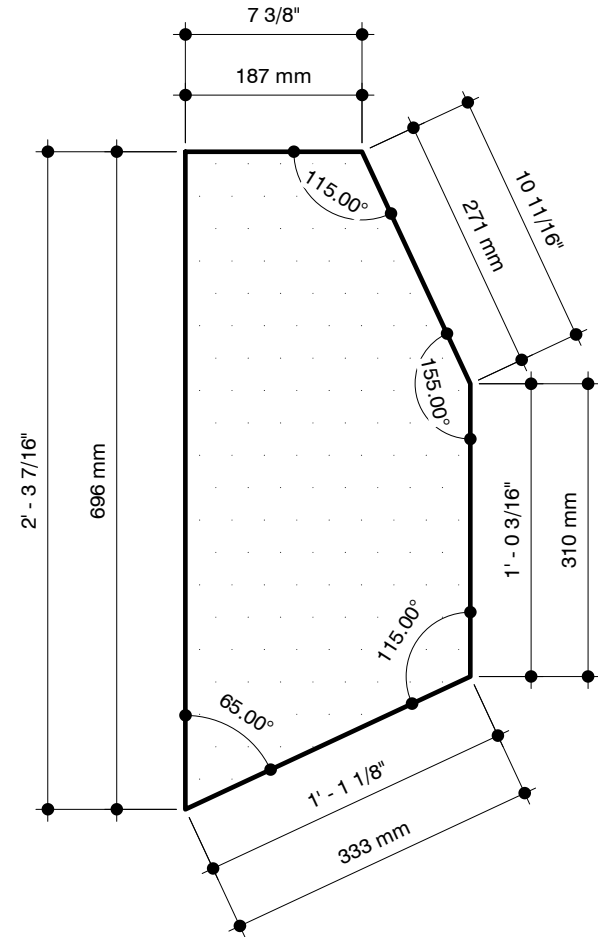

Stone Project Example

6250 Westpark Suite 218 Houston Texas 77057

Date: 02/22/09	Material: Tan Brown Granite	Finish: Polished	Thickness: 2cm	Ticket Number: TB39
----------------	-----------------------------	------------------	----------------	----------------------------

Mark	Stone Type	Quantity	Area	
			Imperial	Metric
B40	ST-2	1	0.459 SF	0.043 m ²

Abbreviations
 FE - Finished Edge QME - Quirk Mitre Edge

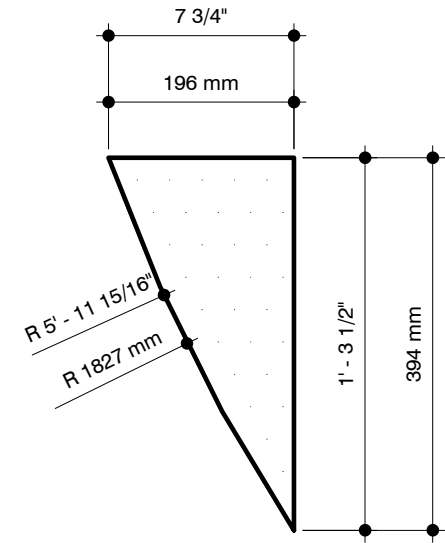

Stone Project Example

6250 Westpark Suite 218 Houston Texas 77057

Date: 02/22/09	Material: Tan Brown Granite	Finish: Polished	Thickness: 2cm	Ticket Number: TB40
----------------	-----------------------------	------------------	----------------	----------------------------

Mark	Stone Type	Quantity	Area	
			Imperial	Metric
B42	ST-2	1	1.911 SF	0.178 m ²

Abbreviations
 FE - Finished Edge QME - Quirk Mitre Edge

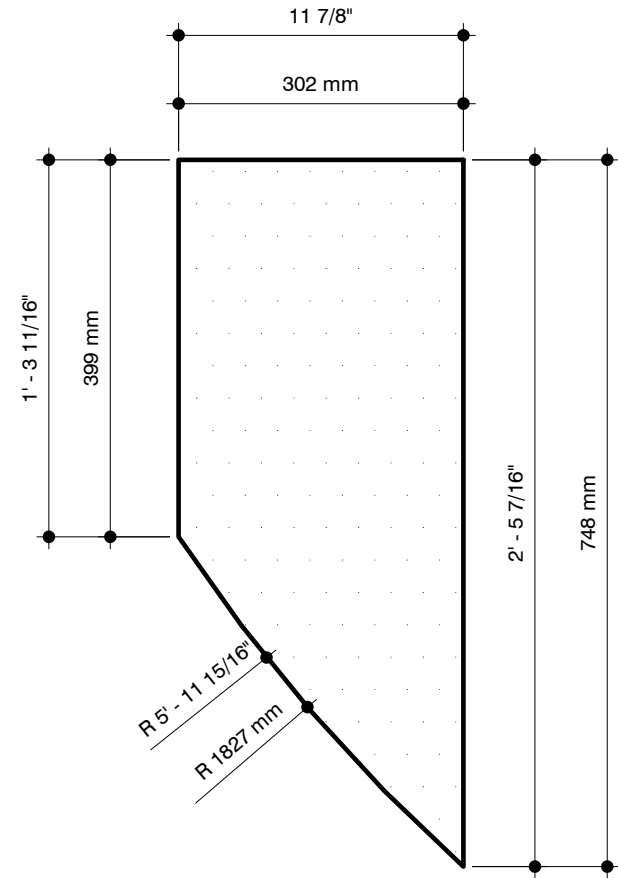

Stone Project Example

6250 Westpark Suite 218 Houston Texas 77057

Date: 02/22/09	Material: Tan Brown Granite	Finish: Polished	Thickness: 2cm	Ticket Number: TB41
----------------	-----------------------------	------------------	----------------	----------------------------

Mark	Stone Type	Quantity	Area	
			Imperial	Metric
B43	ST-2	1	2.494 SF	0.232 m ²

Abbreviations
 FE - Finished Edge QME - Quirk Mitre Edge

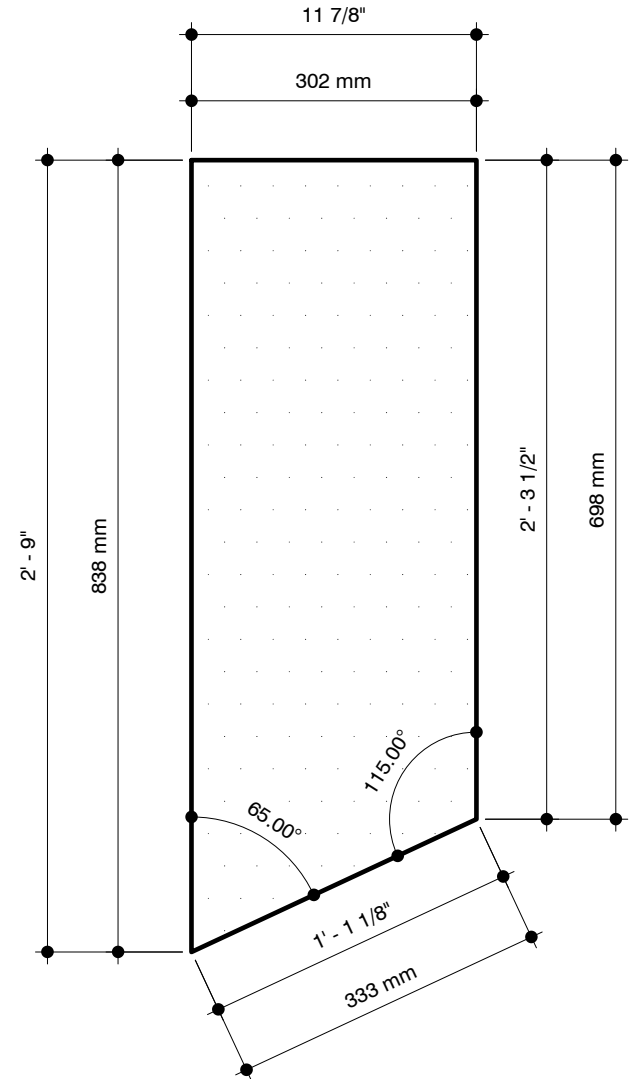

Stone Project Example

6250 Westpark Suite 218 Houston Texas 77057

Date: 02/22/09	Material: Tan Brown Granite	Finish: Polished	Thickness: 2cm	Ticket Number: TB42
----------------	-----------------------------	------------------	----------------	----------------------------

Mark	Stone Type	Quantity	Area	
			Imperial	Metric
B44	ST-2	1	0.188 SF	0.017 m ²

Abbreviations
 FE - Finished Edge QME - Quirk Mitre Edge

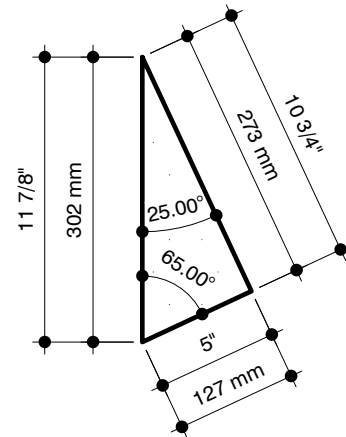

Stone Project Example

6250 Westpark Suite 218 Houston Texas 77057

Date: 02/22/09	Material: Tan Brown Granite	Finish: Polished	Thickness: 2cm	Ticket Number: TB43
----------------	-----------------------------	------------------	----------------	----------------------------

Mark	Stone Type	Quantity	Area	
			Imperial	Metric
B45	ST-2	1	1.109 SF	0.103 m ²

Abbreviations
 FE - Finished Edge QME - Quirk Mitre Edge

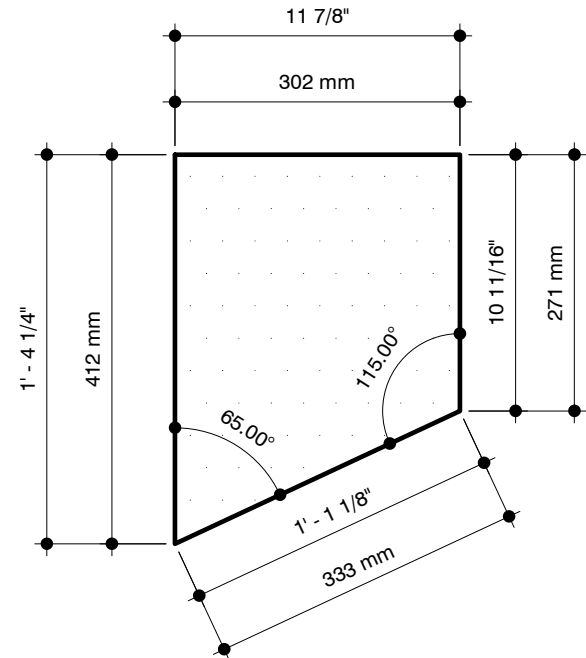

Stone Project Example

6250 Westpark Suite 218 Houston Texas 77057

Date: 02/22/09

Material: Tan Brown Granite

Finish: Polished

Thickness: 2cm

Ticket Number: **TB44**

Mark	Stone Type	Quantity	Area	
			Imperial	Metric
B46	ST-2	1	0.188 SF	0.018 m ²

Abbreviations
 FE - Finished Edge QME - Quirk Mitre Edge

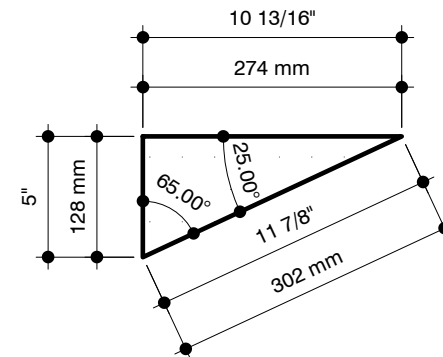

Stone Project Example

6250 Westpark Suite 218 Houston Texas 77057

Date: 02/22/09	Material: Tan Brown Granite	Finish: Polished	Thickness: 2cm	Ticket Number: TB45
----------------	-----------------------------	------------------	----------------	----------------------------

Mark	Stone Type	Quantity	Area	
			Imperial	Metric
B61	ST-2	1	2.735 SF	0.254 m ²

Abbreviations
 FE - Finished Edge QME - Quirk Mitre Edge

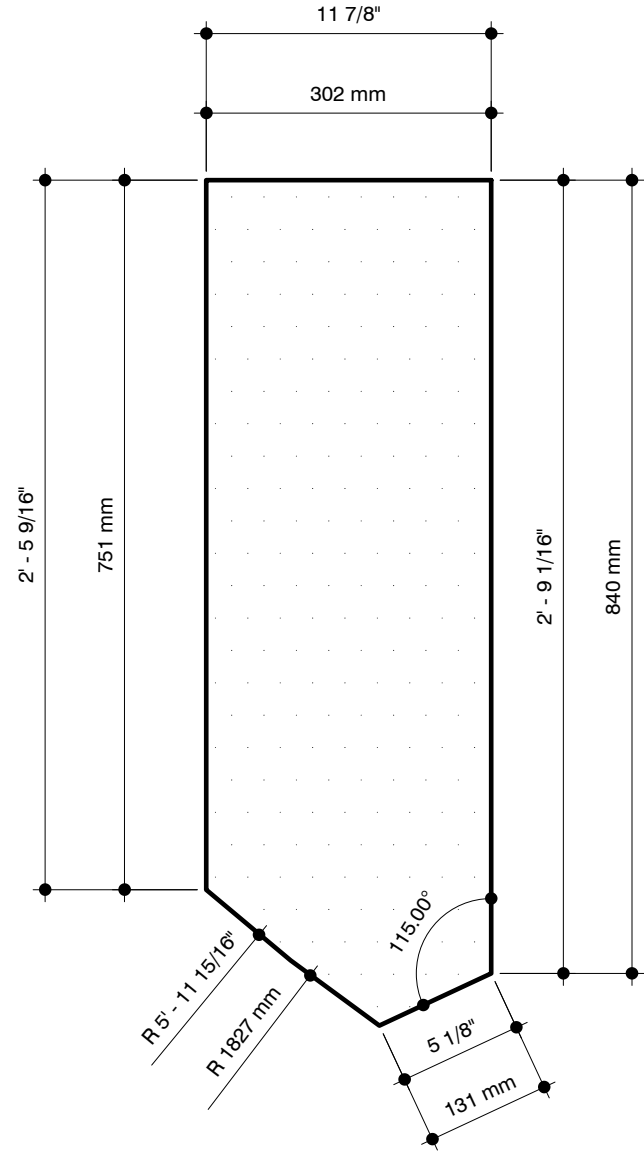

Stone Project Example

6250 Westpark Suite 218 Houston Texas 77057

Date: 02/22/09	Material: Tan Brown Granite	Finish: Polished	Thickness: 2cm	Ticket Number: TB46
----------------	-----------------------------	------------------	----------------	----------------------------

Mark	Stone Type	Quantity	Area	
			Imperial	Metric
B50	ST-2	1	1.294 SF	0.120 m ²

Abbreviations
 FE - Finished Edge QME - Quirk Mitre Edge

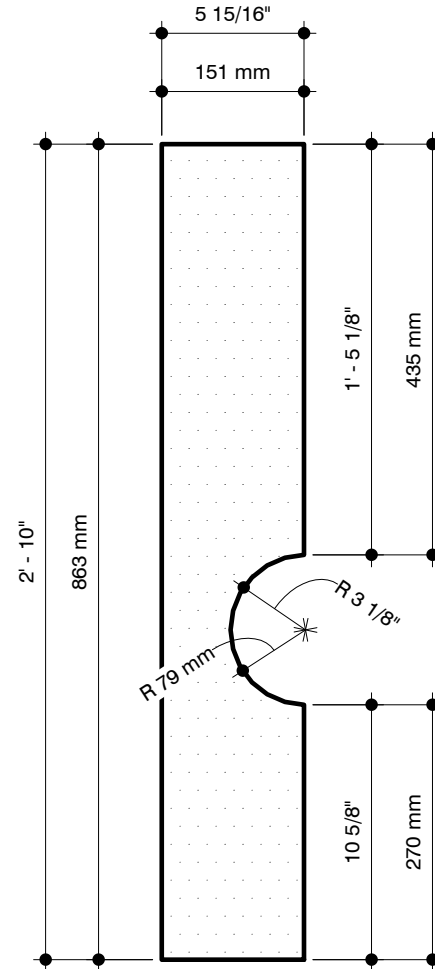

Stone Project Example

6250 Westpark Suite 218 Houston Texas 77057

Date: 02/21/09

Material: Tan Brown Granite

Finish: Polished

Thickness: 2cm

Ticket Number: **TB47**

Mark	Stone Type	Quantity	Area	
			Imperial	Metric
B52	ST-2	1	2.710 SF	0.252 m ²

Abbreviations
 FE - Finished Edge QME - Quirk Mitre Edge

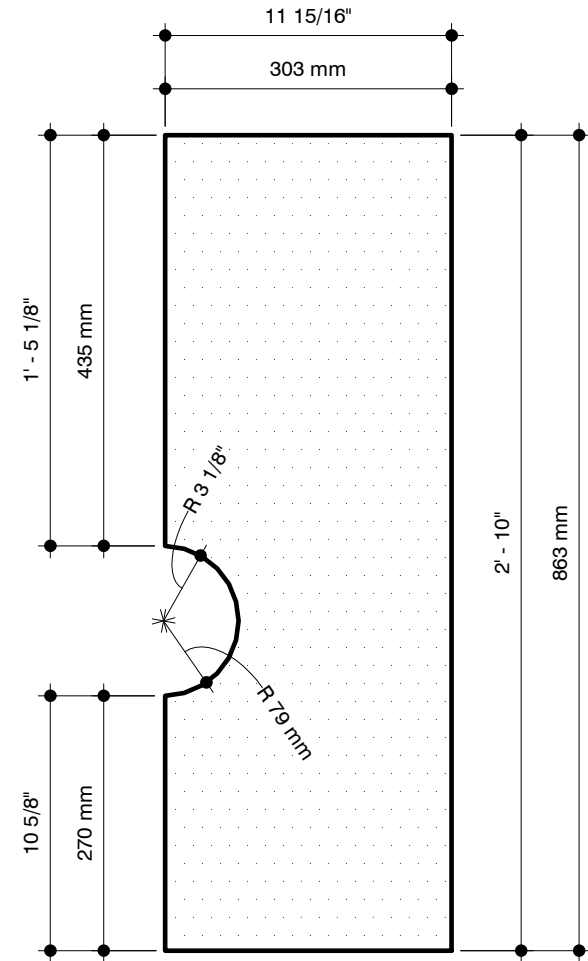

Stone Project Example

6250 Westpark Suite 218 Houston Texas 77057

Date: 02/21/09

Material: Tan Brown Granite

Finish: Polished

Thickness: 2cm

Ticket Number: **TB48**

Mark	Stone Type	Quantity	Area	
			Imperial	Metric
B53	ST-2	5	9.991 SF	0.928 m ²

Abbreviations
 FE - Finished Edge QME - Quirk Mitre Edge

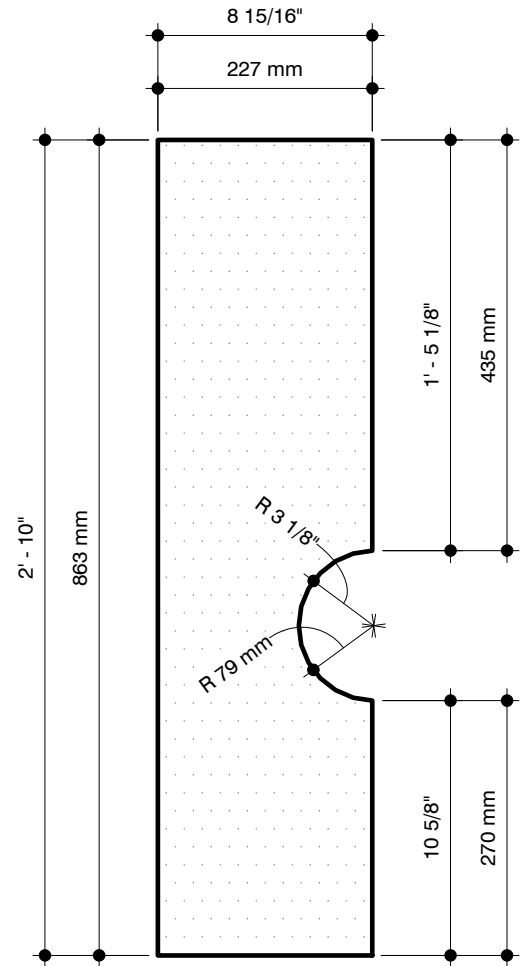

Stone Project Example

6250 Westpark Suite 218 Houston Texas 77057

Date: 02/21/09	Material: Tan Brown Granite	Finish: Polished	Thickness: 2cm	Ticket Number: TB49
----------------	-----------------------------	------------------	----------------	----------------------------

Mark	Stone Type	Quantity	Area	
			Imperial	Metric
B56	ST-2	5	10.028 SF	0.932 m ²

Abbreviations
 FE - Finished Edge QME - Quirk Mitre Edge

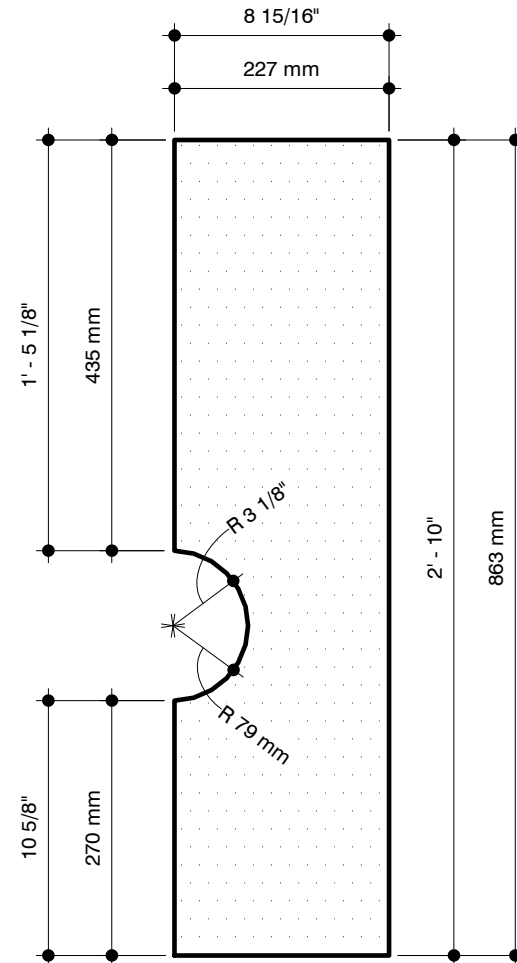

Stone Project Example

6250 Westpark Suite 218 Houston Texas 77057

Date: 02/21/09	Material: Tan Brown Granite	Finish: Polished	Thickness: 2cm	Ticket Number: TB50
----------------	-----------------------------	------------------	----------------	----------------------------

Mark	Stone Type	A		B		Quantity	Area	
		Imperial	Metric	Imperial	Metric		Imperial	Metric
B88	ST-2	11 7/8"	302 mm	2' - 0"	610 mm	12	23.750 SF	2.206 m ²
B89	ST-2	1' - 0 3/16"	310 mm	1' - 6 7/8"	479 mm	4	6.390 SF	0.594 m ²
B90	ST-2	1' - 0 1/4"	311 mm	1' - 6 7/8"	479 mm	12	19.268 SF	1.790 m ²
B91	ST-2	11 7/8"	302 mm	1' - 6 7/8"	479 mm	16	24.905 SF	2.314 m ²
B92	ST-2	2' - 7 13/16"	808 mm	11 15/16"	303 mm	6	15.823 SF	1.470 m ²
B96	ST-2	2' - 7 13/16"	808 mm	9 3/16"	233 mm	3	6.089 SF	0.566 m ²
B97	ST-2	2' - 7 13/16"	808 mm	11 15/16"	303 mm	1	2.637 SF	0.245 m ²
B98	ST-2	2' - 7 13/16"	808 mm	11 13/16"	300 mm	1	2.610 SF	0.242 m ²
B101	ST-2	1' - 5 9/16"	446 mm	11 7/8"	302 mm	18	26.069 SF	2.422 m ²
B102	ST-2	1' - 5 9/16"	446 mm	11 3/4"	298 mm	2	2.866 SF	0.266 m ²
B103	ST-2	1' - 8 13/16"	529 mm	11 7/8"	302 mm	83	142.454 SF	13.234 m ²
B104	ST-2	1' - 8 13/16"	529 mm	11 3/4"	298 mm	2	3.396 SF	0.316 m ²
B105	ST-2	1' - 8 13/16"	529 mm	10 5/8"	270 mm	4	6.143 SF	0.571 m ²
B106	ST-2	1' - 11 7/8"	606 mm	10 5/8"	270 mm	4	7.046 SF	0.655 m ²
B107	ST-2	1' - 11 7/8"	606 mm	11 7/8"	302 mm	54	106.318 SF	9.877 m ²
B108	ST-2	1' - 11 7/8"	606 mm	11 3/4"	298 mm	2	3.896 SF	0.362 m ²
B109	ST-2	1' - 8 13/16"	529 mm	11 13/16"	300 mm	1	1.707 SF	0.159 m ²
B110	ST-2	1' - 11 7/8"	606 mm	11 13/16"	300 mm	1	1.958 SF	0.182 m ²
B111	ST-2	1' - 11 7/8"	606 mm	8 5/16"	211 mm	10	13.782 SF	1.280 m ²
B112	ST-2	1' - 10 13/16"	579 mm	11 7/8"	302 mm	8	15.050 SF	1.398 m ²
B113	ST-2	1' - 8 13/16"	529 mm	11 7/16"	291 mm	1	1.653 SF	0.154 m ²
B114	ST-2	1' - 11 13/16"	605 mm	11 7/16"	291 mm	1	1.891 SF	0.176 m ²
B115	ST-2	1' - 11 3/16"	589 mm	11 7/8"	302 mm	8	15.297 SF	1.421 m ²
B116	ST-2	1' - 11 1/8"	587 mm	11 7/8"	302 mm	8	15.256 SF	1.417 m ²
B117	ST-2	1' - 10 15/16"	583 mm	11 7/8"	302 mm	8	15.132 SF	1.406 m ²
B118	ST-2	1' - 11 3/16"	589 mm	1' - 0 15/16"	329 mm	2	4.167 SF	0.387 m ²
B119	ST-2	1' - 11 1/8"	587 mm	1' - 0 15/16"	329 mm	2	4.155 SF	0.386 m ²
B120	ST-2	1' - 10 15/16"	583 mm	1' - 0 15/16"	329 mm	2	4.122 SF	0.383 m ²
B121	ST-2	2' - 7 13/16"	808 mm	9 3/16"	233 mm	1	2.030 SF	0.189 m ²
B122	ST-2	1' - 0 1/4"	311 mm	1' - 6 7/16"	468 mm	2	3.137 SF	0.291 m ²
B123	ST-2	11 7/8"	302 mm	1' - 6 7/16"	468 mm	4	6.082 SF	0.565 m ²
B124	ST-2	1' - 0 1/4"	311 mm	1' - 6 7/16"	468 mm	1	1.568 SF	0.146 m ²
B125	ST-2	3' - 11 13/16"	1214 mm	9 1/4"	235 mm	1	3.071 SF	0.285 m ²
B126	ST-2	2' - 0 7/8"	632 mm	1' - 0"	305 mm	6	12.438 SF	1.155 m ²
Grand total						291	522.158 SF	48.510 m ²

Abbreviations
FE - Finished Edge QME - Quirk Mitre Edge

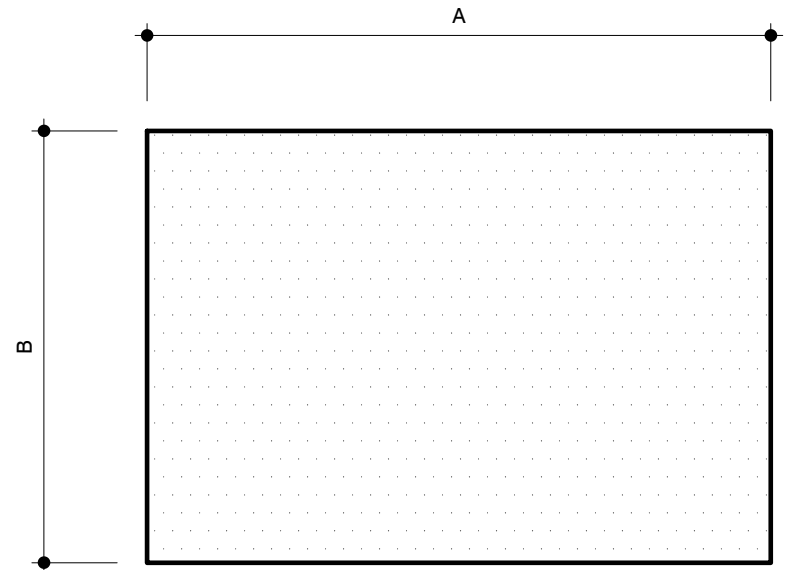

Stone Project Example

6250 Westpark Suite 218 Houston Texas 77057

Date: 02/19/09

Material: Tan Brown Granite

Finish: Polished

Thickness: 2cm

Ticket Number: **TB51**

Mark	Stone Type	A		B		Quantity	Area	
		Imperial	Metric	Imperial	Metric		Imperial	Metric
B128	ST-2	2' - 11 3/4"	908 mm	2 5/8"	67 mm	1	0.652 SF	0.061 m ²
B130	ST-2	6 3/8"	162 mm	1' - 0"	305 mm	1	0.531 SF	0.049 m ²
B131	ST-2	10 1/4"	260 mm	1' - 0"	305 mm	1	0.854 SF	0.079 m ²
Grand total						3	2.037 SF	0.189 m ²

Abbreviations
 FE - Finished Edge QME - Quirk Mitre Edge

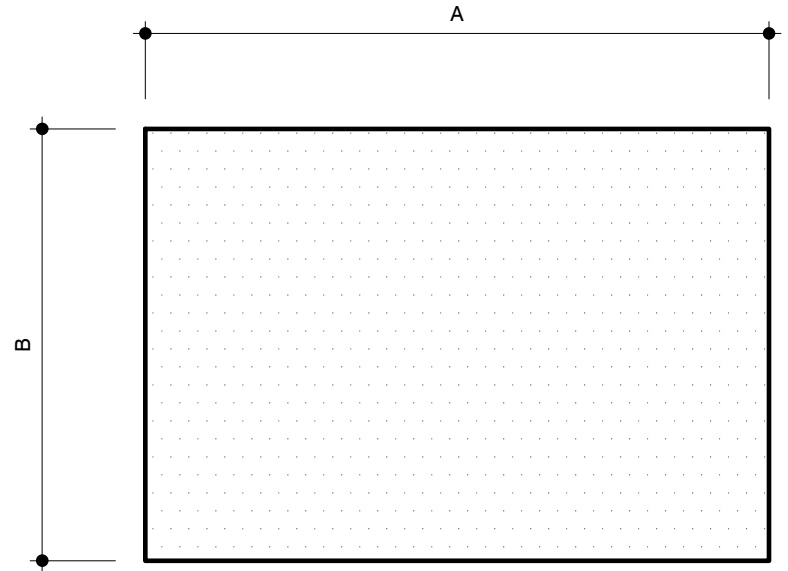

Stone Project Example

6250 Westpark Suite 218 Houston Texas 77057

Date: 02/19/09

Material: Tan Brown Granite

Finish: Polished

Thickness: 2cm

Ticket Number: **TB52**

Mark	Stone Type	A		B		Quantity	Area	
		Imperial	Metric	Imperial	Metric		Imperial	Metric
B48	ST-2	1' - 6"	457 mm	11 7/8"	302 mm	42	62.344 SF	5.792 m ²
B49	ST-2	1' - 6"	457 mm	6 5/16"	160 mm	6	4.737 SF	0.440 m ²
B51	ST-2	1' - 6"	457 mm	8 9/16"	217 mm	6	6.422 SF	0.597 m ²
B58	ST-2	2' - 6"	762 mm	11 7/8"	302 mm	10	24.740 SF	2.298 m ²
B59	ST-2	2' - 6"	762 mm	1' - 4 9/16"	421 mm	2	6.901 SF	0.641 m ²
B60	ST-2	1' - 11 7/8"	606 mm	11 7/8"	302 mm	27	53.159 SF	4.939 m ²
B62	ST-2	2' - 8 1/16"	814 mm	11 7/8"	302 mm	26	68.745 SF	6.387 m ²
B63	ST-2	2' - 8 5/8"	829 mm	11 7/8"	302 mm	26	69.951 SF	6.499 m ²
B64	ST-2	2' - 8 9/16"	827 mm	11 7/8"	302 mm	26	69.817 SF	6.486 m ²
B65	ST-2	2' - 8 1/16"	814 mm	6 13/16"	173 mm	2	3.034 SF	0.282 m ²
B66	ST-2	2' - 8 5/8"	829 mm	6 13/16"	173 mm	2	3.087 SF	0.287 m ²
B67	ST-2	2' - 8 9/16"	827 mm	6 13/16"	173 mm	2	3.081 SF	0.286 m ²
B68	ST-2	3' - 3 3/4"	1010 mm	11 7/8"	302 mm	10	32.780 SF	3.045 m ²
B69	ST-2	3' - 3 3/4"	1010 mm	4 9/16"	116 mm	2	2.519 SF	0.234 m ²
B70	ST-2	1' - 0 3/16"	310 mm	1' - 6 7/16"	468 mm	3	4.681 SF	0.435 m ²
B71	ST-2	1' - 0 1/4"	311 mm	1' - 6 7/16"	468 mm	3	4.705 SF	0.437 m ²
B74	ST-2	11 7/8"	302 mm	1' - 6 7/16"	468 mm	12	18.245 SF	1.695 m ²
B75	ST-2	1' - 0 3/16"	310 mm	1' - 6 7/16"	468 mm	1	1.560 SF	0.145 m ²
B77	ST-2	1' - 0 1/4"	311 mm	1' - 6 7/16"	468 mm	6	9.411 SF	0.874 m ²
B79	ST-2	2' - 7 13/16"	808 mm	9 1/16"	230 mm	8	16.017 SF	1.488 m ²
B80	ST-2	2' - 7 13/16"	808 mm	9 1/8"	232 mm	4	8.064 SF	0.749 m ²
B81	ST-2	2' - 7 13/16"	808 mm	9 3/8"	238 mm	8	16.569 SF	1.539 m ²
B83	ST-2	1' - 0 3/16"	310 mm	1' - 6 1/4"	464 mm	4	6.178 SF	0.574 m ²
B84	ST-2	1' - 0 1/4"	311 mm	1' - 6 1/4"	464 mm	12	18.630 SF	1.731 m ²
B85	ST-2	11 7/8"	302 mm	1' - 6 1/4"	464 mm	16	24.080 SF	2.237 m ²
B86	ST-2	1' - 0 3/16"	310 mm	2' - 0"	610 mm	3	6.094 SF	0.566 m ²
B87	ST-2	1' - 0 1/4"	311 mm	2' - 0"	610 mm	9	18.375 SF	1.707 m ²
Grand total						278	563.927 SF	52.391 m ²

Abbreviations
FE - Finished Edge QME - Quirk Mitre Edge

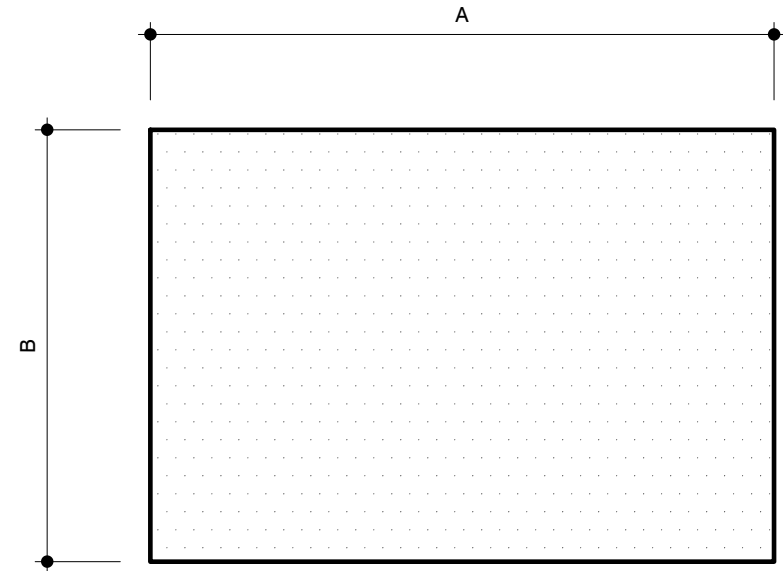

Stone Project Example

6250 Westpark Suite 218 Houston Texas 77057

Date: 02/15/09

Material: Tan Brown Granite

Finish: Polished

Thickness: 2cm

Ticket Number: **TB53**

Mark	Stone Type	Quantity	Area	
			Imperial	Metric
C1	ST-3	1	1.115 SF	0.104 m ²

Abbreviations
 FE - Finished Edge QME - Quirk Mitre Edge

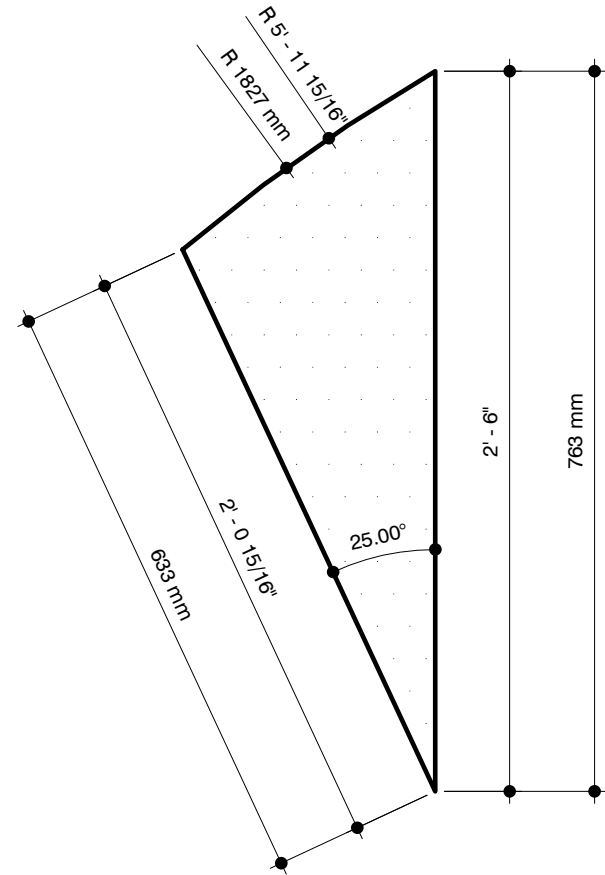

Stone Project Example

6250 Westpark Suite 218 Houston Texas 77057

Date: 02/22/09	Material: Rajah Black Granite	Finish: Polished	Thickness: 2cm	Ticket Number: TC1
----------------	-------------------------------	------------------	----------------	---------------------------

Mark	Stone Type	Quantity	Area	
			Imperial	Metric
C2	ST-3	1	3.123 SF	0.290 m ²

Abbreviations
 FE - Finished Edge QME - Quirk Mitre Edge

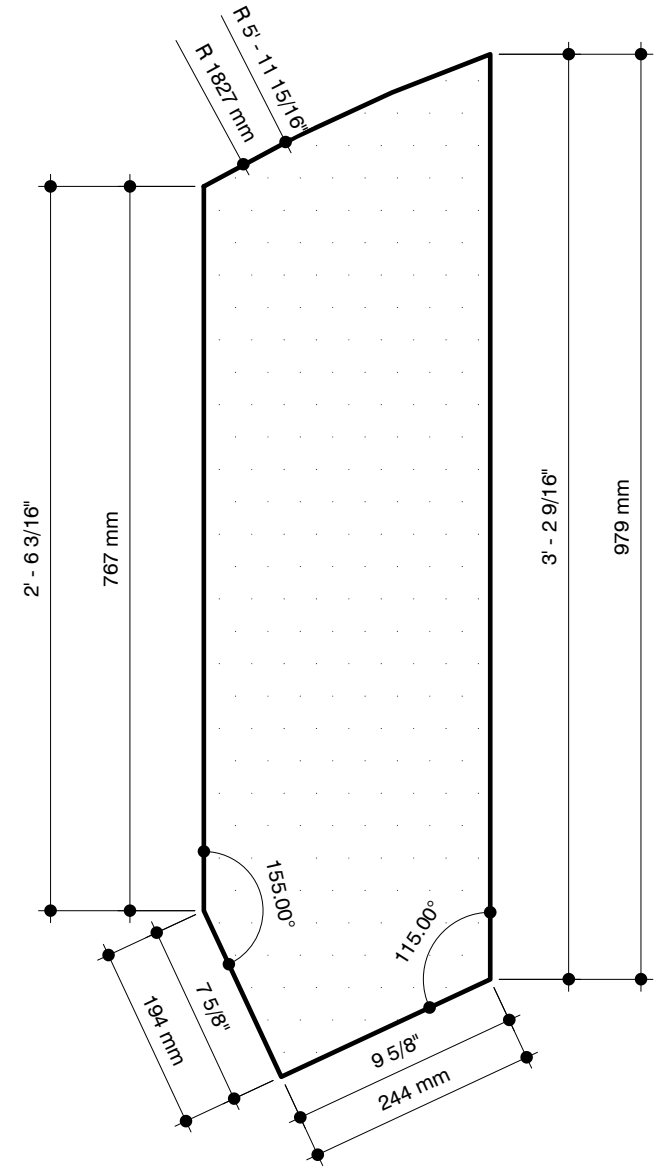

Stone Project Example

6250 Westpark Suite 218 Houston Texas 77057

Date: 02/22/09	Material: Rajah Black Granite	Finish: Polished	Thickness: 2cm	Ticket Number: TC2
----------------	-------------------------------	------------------	----------------	---------------------------

Mark	Stone Type	Quantity	Area	
			Imperial	Metric
C3	ST-3	1	3.093 SF	0.287 m ²

Abbreviations
 FE - Finished Edge QME - Quirk Mitre Edge

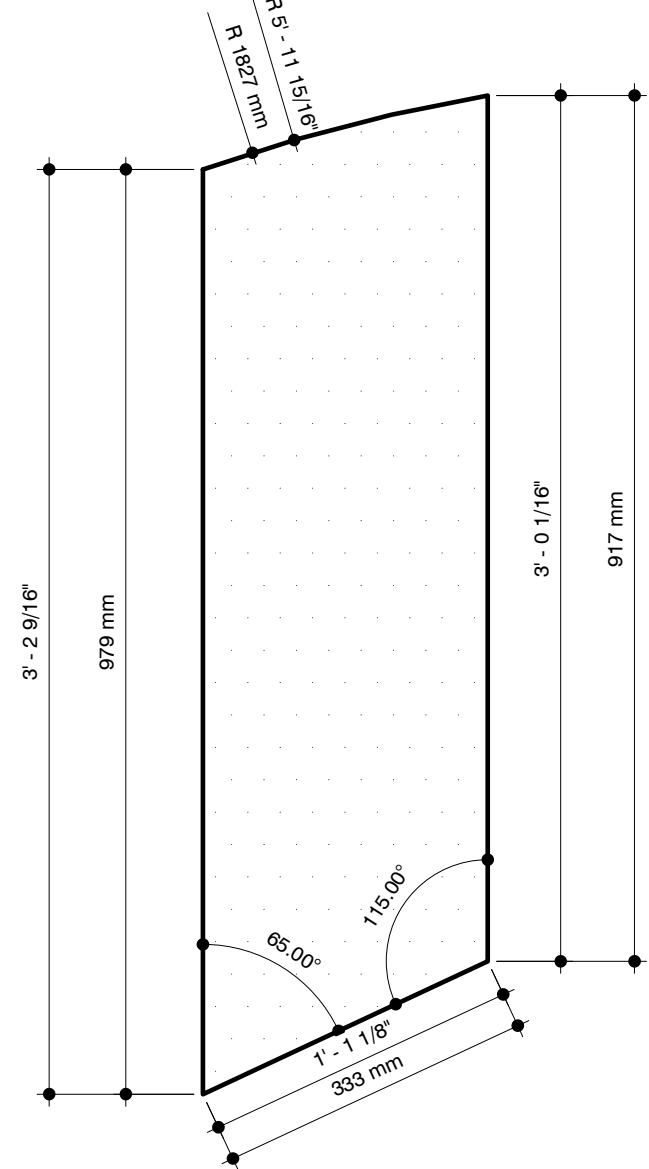

Stone Project Example

6250 Westpark Suite 218 Houston Texas 77057

Date: 02/22/09	Material: Rajah Black Granite	Finish: Polished	Thickness: 2cm	Ticket Number: TC3
----------------	-------------------------------	------------------	----------------	---------------------------

Mark	Stone Type	Quantity	Area	
			Imperial	Metric
C4	ST-3	1	2.800 SF	0.260 m ²

Abbreviations
 FE - Finished Edge QME - Quirk Mitre Edge

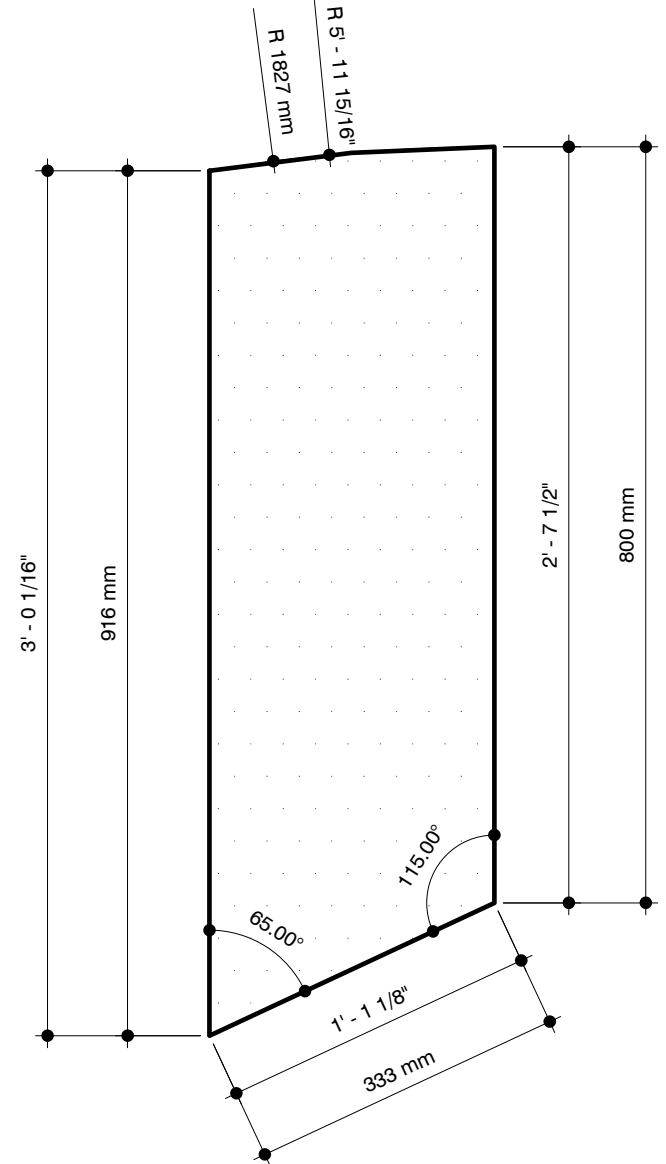

Stone Project Example

6250 Westpark Suite 218 Houston Texas 77057

Date: 02/23/09	Material: Rajah Black Granite	Finish: Polished	Thickness: 2cm	Ticket Number: TC4
----------------	-------------------------------	------------------	----------------	---------------------------

Mark	Stone Type	Quantity	Area	
			Imperial	Metric
C5	ST-3	1	2.338 SF	0.217 m ²

Abbreviations
 FE - Finished Edge QME - Quirk Mitre Edge

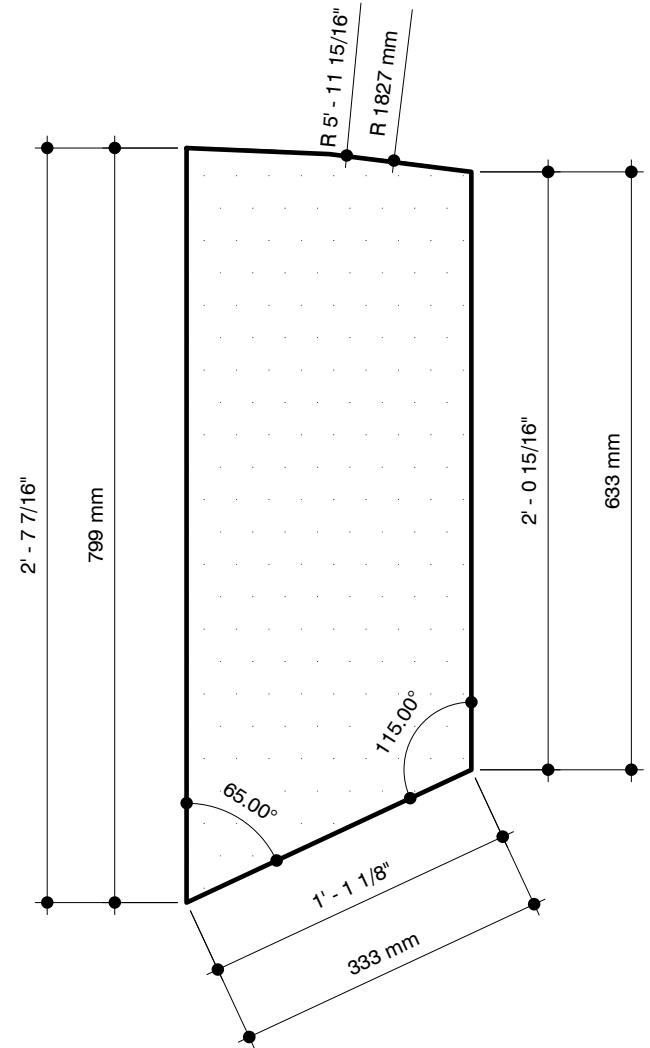

Stone Project Example

6250 Westpark Suite 218 Houston Texas 77057

Date: 02/23/09	Material: Rajah Black Granite	Finish: Polished	Thickness: 2cm	Ticket Number: TC5
----------------	-------------------------------	------------------	----------------	---------------------------

Mark	Stone Type	Quantity	Area	
			Imperial	Metric
C6	ST-3	1	1.708 SF	0.159 m ²

Abbreviations
 FE - Finished Edge QME - Quirk Mitre Edge

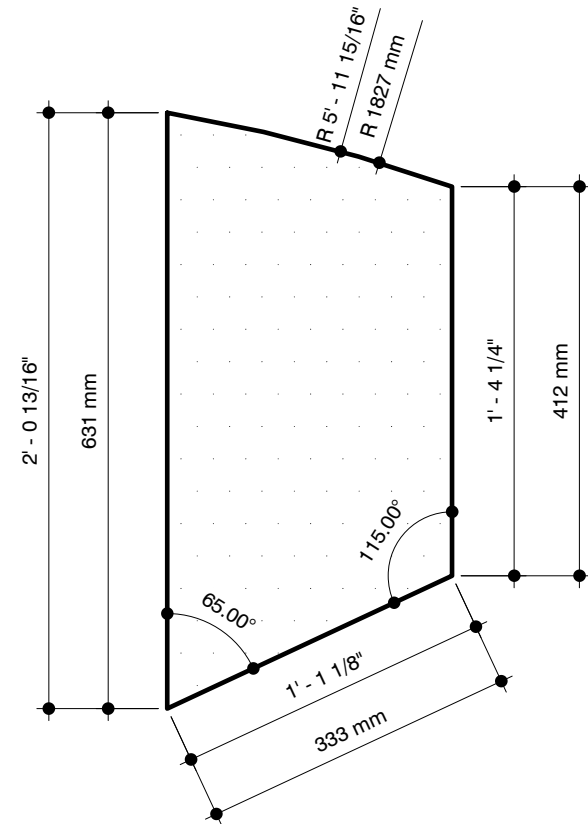

Stone Project Example

6250 Westpark Suite 218 Houston Texas 77057

Date: 02/23/09	Material: Rajah Black Granite	Finish: Polished	Thickness: 2cm	Ticket Number: TC6
----------------	-------------------------------	------------------	----------------	---------------------------

Mark	Stone Type	Quantity	Area	
			Imperial	Metric
C7	ST-3	1	0.977 SF	0.091 m ²

Abbreviations
 FE - Finished Edge QME - Quirk Mitre Edge

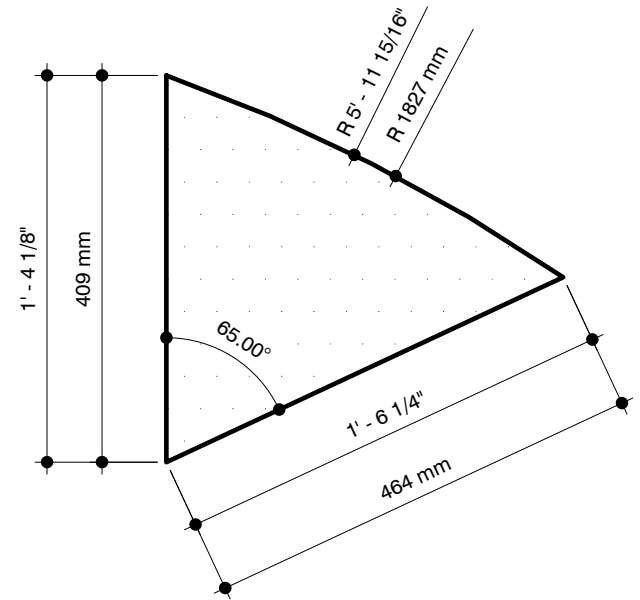

Stone Project Example

6250 Westpark Suite 218 Houston Texas 77057

Date: 02/23/09	Material: Rajah Black Granite	Finish: Polished	Thickness: 2cm	Ticket Number: TC7
----------------	-------------------------------	------------------	----------------	---------------------------

Mark	Stone Type	Quantity	Area	
			Imperial	Metric
C9	ST-3	1	0.838 SF	0.078 m ²

Abbreviations
 FE - Finished Edge QME - Quirk Mitre Edge

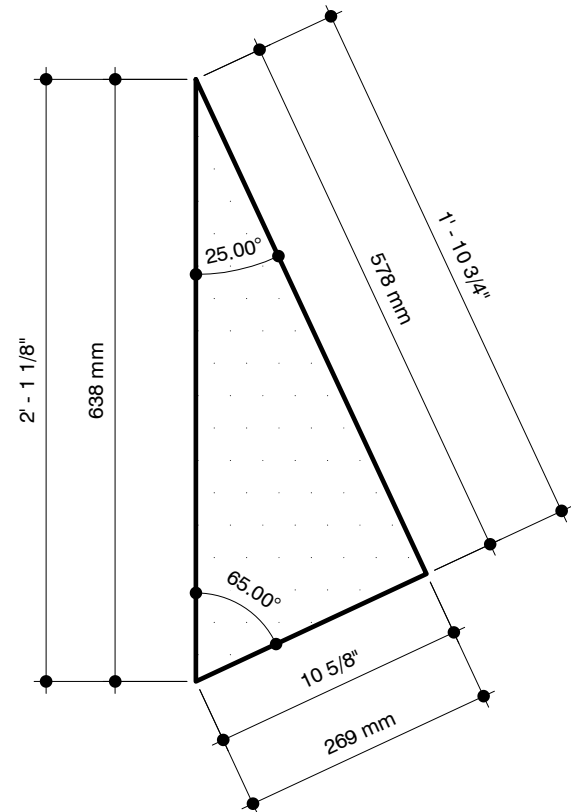

Stone Project Example

6250 Westpark Suite 218 Houston Texas 77057

Date: 02/23/09	Material: Rajah Black Granite	Finish: Polished	Thickness: 2cm	Ticket Number: TCS
----------------	-------------------------------	------------------	----------------	---------------------------

Mark	Stone Type	Quantity	Area	
			Imperial	Metric
C10	ST-3	1	2.522 SF	0.234 m ²

Abbreviations
 FE - Finished Edge QME - Quirk Mitre Edge

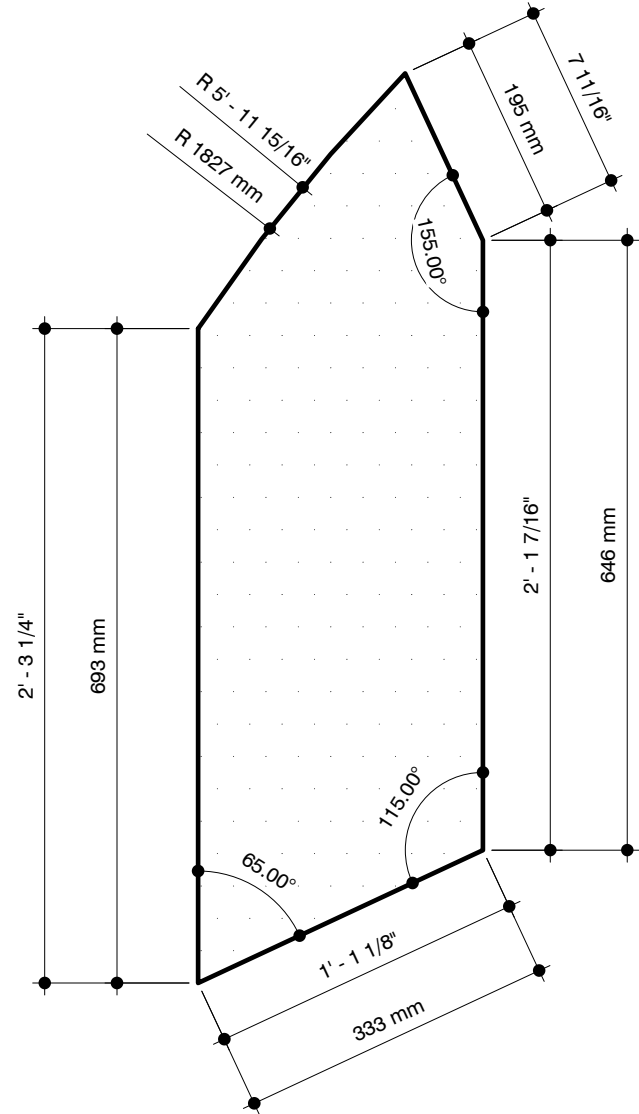

Stone Project Example

6250 Westpark Suite 218 Houston Texas 77057

Date: 02/23/09	Material: Rajah Black Granite	Finish: Polished	Thickness: 2cm	Ticket Number: TC9
----------------	-------------------------------	------------------	----------------	---------------------------

Mark	Stone Type	Quantity	Area	
			Imperial	Metric
C11	ST-3	1	1.423 SF	0.132 m ²

Abbreviations
 FE - Finished Edge QME - Quirk Mitre Edge

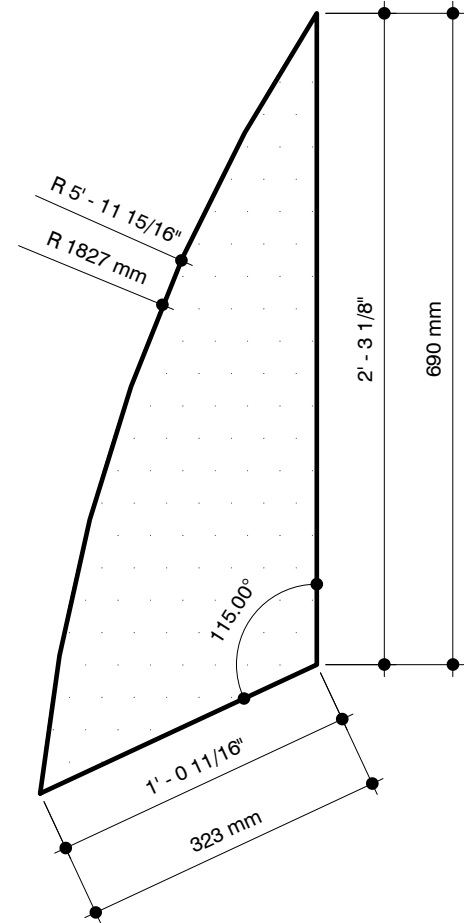

Stone Project Example

6250 Westpark Suite 218 Houston Texas 77057

Date: 02/23/09	Material: Rajah Black Granite	Finish: Polished	Thickness: 2cm	Ticket Number: TC10
----------------	-------------------------------	------------------	----------------	----------------------------

+

Mark	Stone Type	Quantity	Area	
			Imperial	Metric
C12	ST-3	1	2.636 SF	0.245 m ²

Abbreviations
 FE - Finished Edge QME - Quirk Mitre Edge

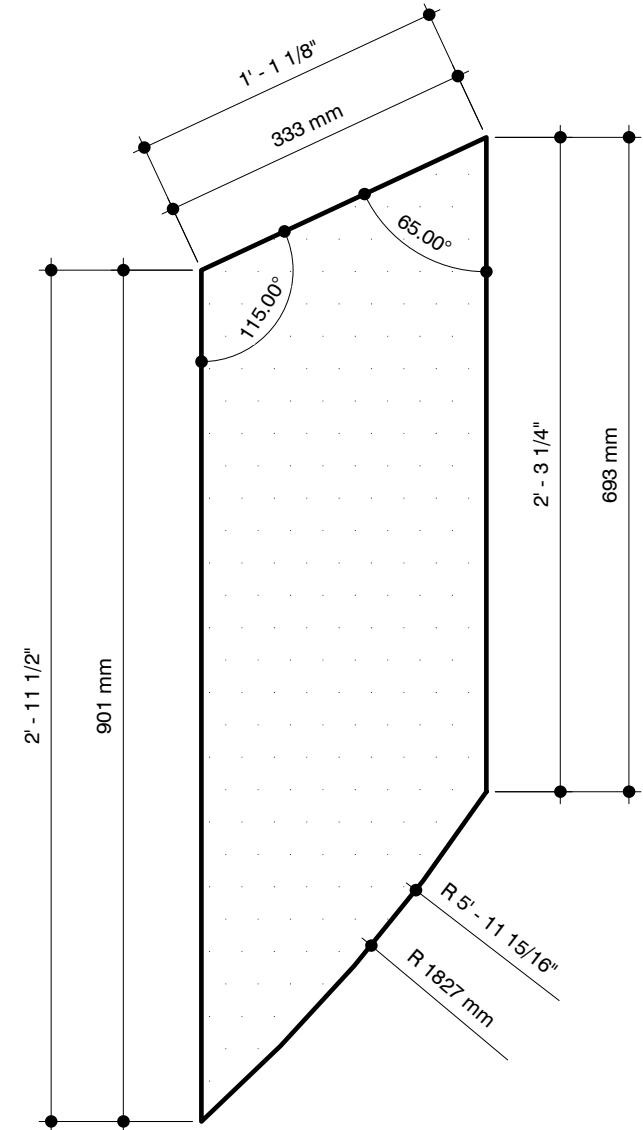

Stone Project Example

6250 Westpark Suite 218 Houston Texas 77057

Date: 02/23/09

Material: Rajah Black Granite

Finish: Polished

Thickness: 2cm

Ticket Number: **TC11**

Mark	Stone Type	Quantity	Area	
			Imperial	Metric
C13	ST-3	1	1.423 SF	0.132 m ²

Abbreviations
 FE - Finished Edge QME - Quirk Mitre Edge

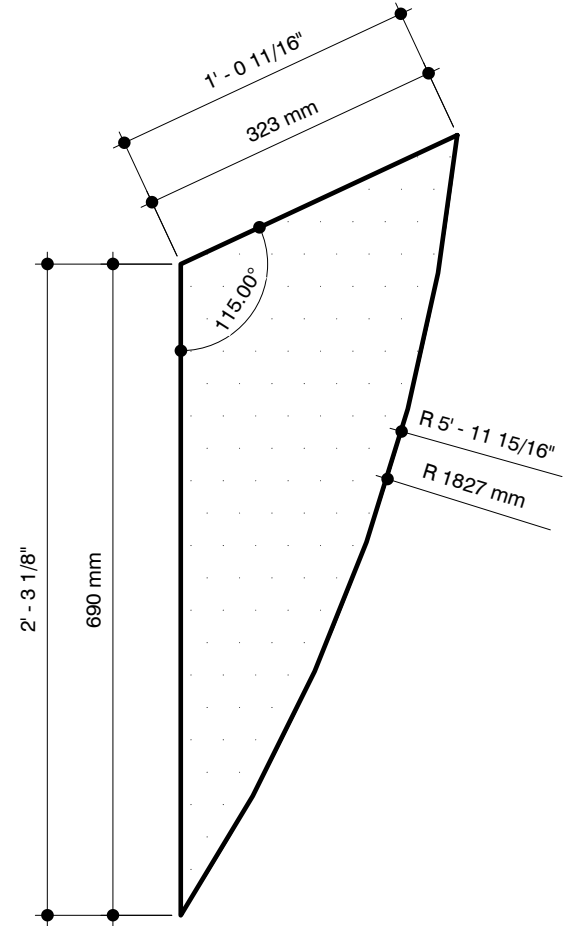

Stone Project Example

6250 Westpark Suite 218 Houston Texas 77057

Date: 02/23/09

Material: Rajah Black Granite

Finish: Polished

Thickness: 2cm

Ticket Number: **TC12**

Mark	Stone Type	Quantity	Area	
			Imperial	Metric
C15	ST-3	1	1.019 SF	0.095 m ²

Abbreviations
 FE - Finished Edge QME - Quirk Mitre Edge

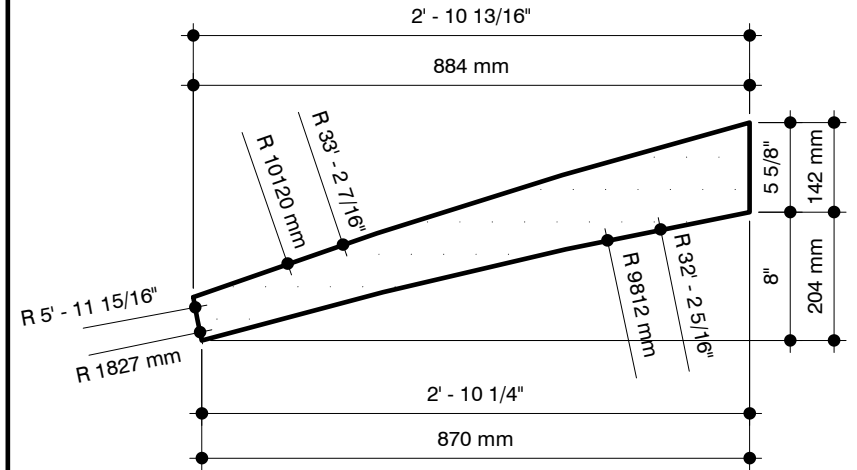

Stone Project Example

6250 Westpark Suite 218 Houston Texas 77057

Date: 02/23/09	Material: Rajah Black Granite	Finish: Polished	Thickness: 2cm	Ticket Number: TC13
----------------	-------------------------------	------------------	----------------	----------------------------

Mark	Stone Type	Quantity	Area	
			Imperial	Metric
C18	ST-3	1	0.271 SF	0.025 m ²

Abbreviations
 FE - Finished Edge QME - Quirk Mitre Edge

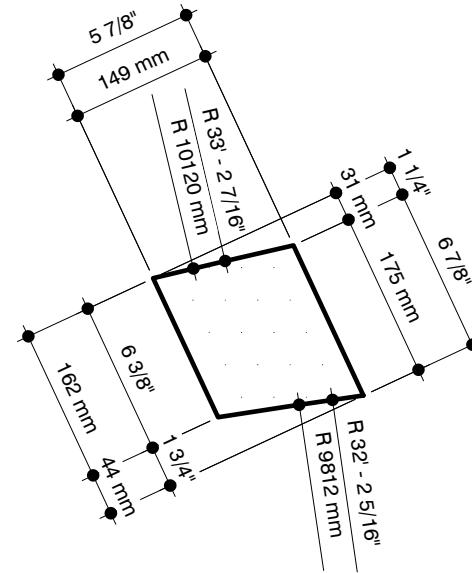

Stone Project Example

6250 Westpark Suite 218 Houston Texas 77057

Date: 02/23/09	Material: Rajah Black Granite	Finish: Polished	Thickness: 2cm	Ticket Number: TC14
----------------	-------------------------------	------------------	----------------	----------------------------

Mark	Stone Type	Quantity	Area	
			Imperial	Metric
C19	ST-3	1	0.383 SF	0.036 m ²

Abbreviations
 FE - Finished Edge QME - Quirk Mitre Edge

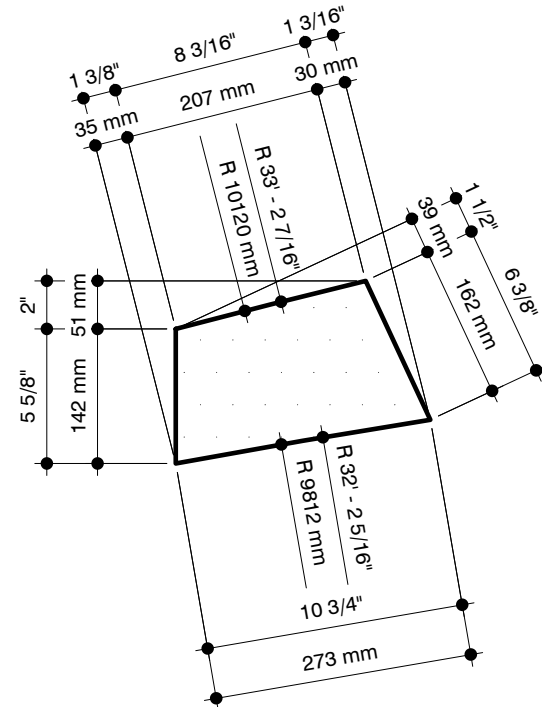

Stone Project Example

6250 Westpark Suite 218 Houston Texas 77057

Date: 02/23/09

Material: Rajah Black Granite

Finish: Polished

Thickness: 2cm

Ticket Number: **TC15**

Mark	Stone Type	Quantity	Area	
			Imperial	Metric
C20	ST-3	1	0.416 SF	0.039 m ²

Abbreviations
 FE - Finished Edge QME - Quirk Mitre Edge

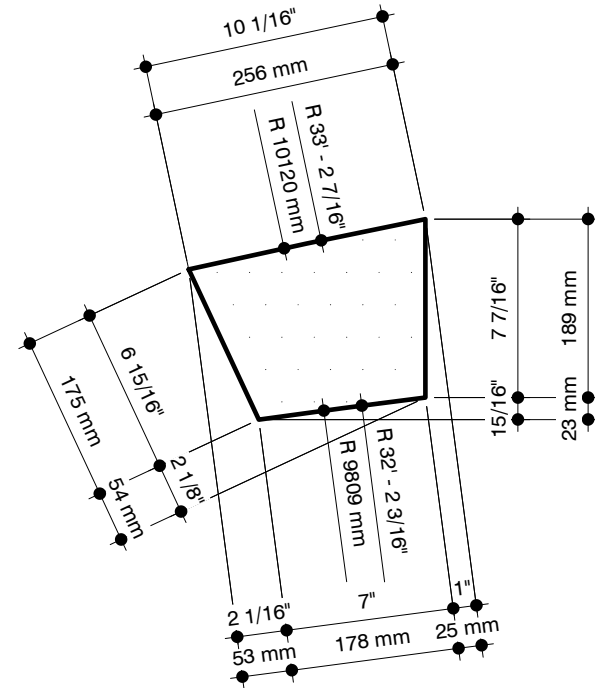

Stone Project Example

6250 Westpark Suite 218 Houston Texas 77057

Date: 02/23/09

Material: Rajah Black Granite

Finish: Polished

Thickness: 2cm

Ticket Number: **TC16**

Mark	Stone Type	Quantity	Area	
			Imperial	Metric
C21	ST-3	1	1.387 SF	0.129 m ²

Abbreviations
 FE - Finished Edge QME - Quirk Mitre Edge

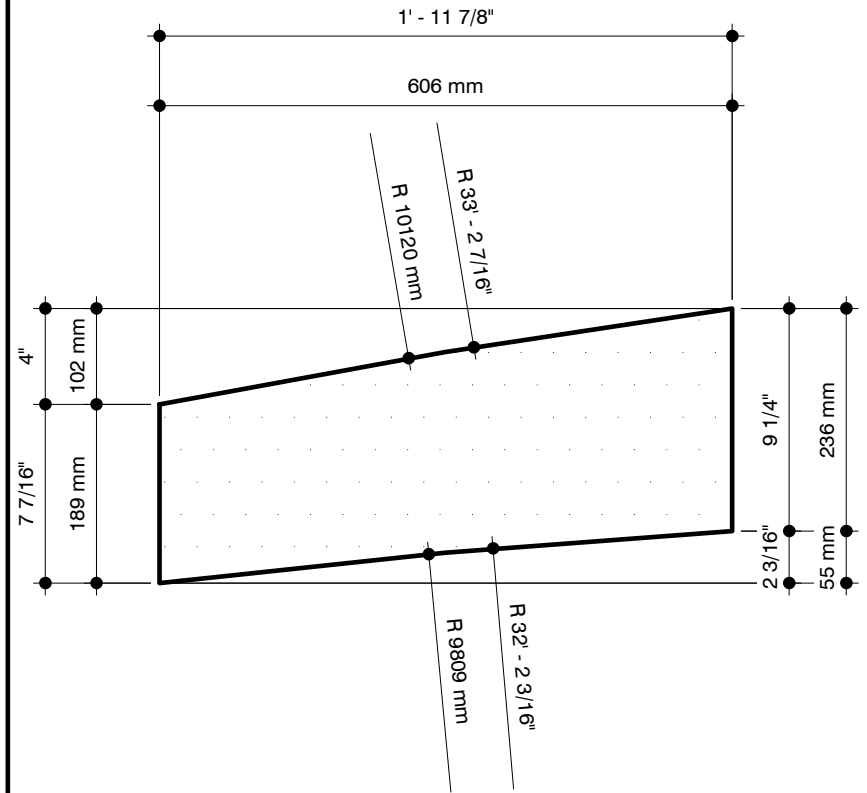

Stone Project Example

6250 Westpark Suite 218 Houston Texas 77057

Date: 02/23/09	Material: Rajah Black Granite	Finish: Polished	Thickness: 2cm	Ticket Number: TC17
----------------	-------------------------------	------------------	----------------	----------------------------

Mark	Stone Type	Quantity	Area	
			Imperial	Metric
C23	ST-3	1	1.693 SF	0.157 m ²

Abbreviations
 FE - Finished Edge QME - Quirk Mitre Edge

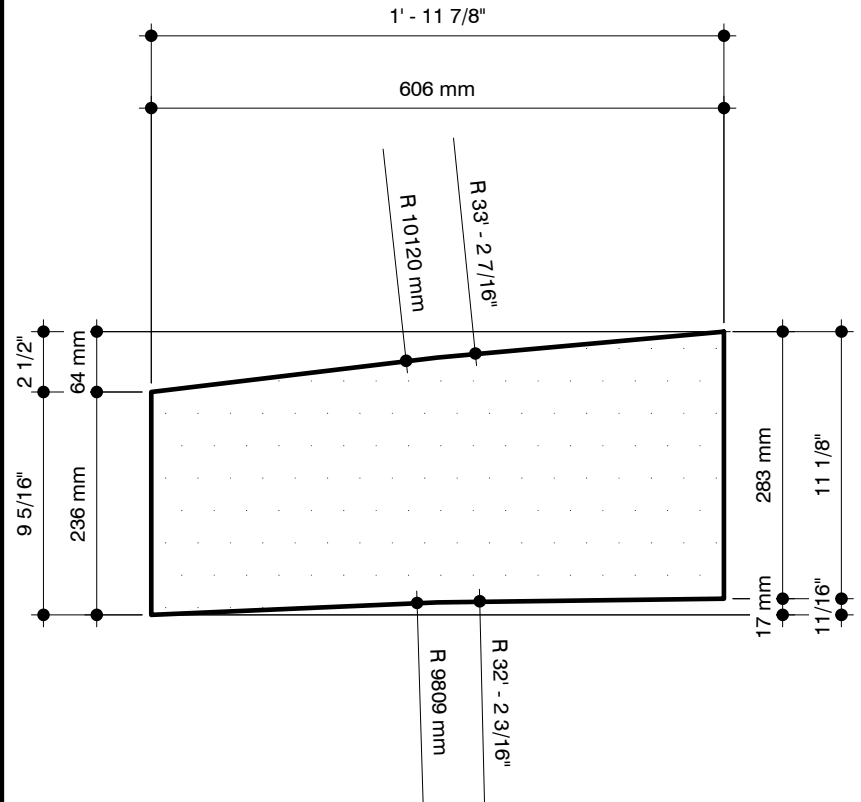

Stone Project Example

6250 Westpark Suite 218 Houston Texas 77057

Date: 02/23/09	Material: Rajah Black Granite	Finish: Polished	Thickness: 2cm	Ticket Number: TC18
----------------	-------------------------------	------------------	----------------	----------------------------

Mark	Stone Type	Quantity	Area	
			Imperial	Metric
C27	ST-3	1	3.102 SF	0.288 m ²

Abbreviations
 FE - Finished Edge QME - Quirk Mitre Edge

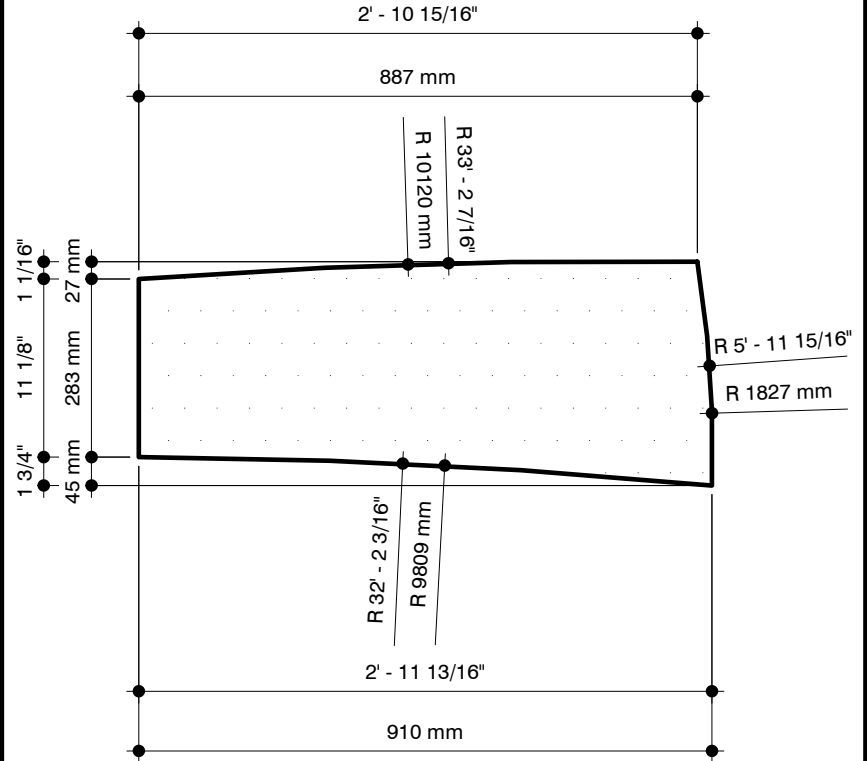

Stone Project Example

6250 Westpark Suite 218 Houston Texas 77057

Date: 02/23/09

Material: Rajah Black Granite

Finish: Polished

Thickness: 2cm

Ticket Number: **TC19**

Mark	Stone Type	Quantity	Area	
			Imperial	Metric
C28	ST-3	1	3.083 SF	0.286 m ²

Abbreviations
 FE - Finished Edge QME - Quirk Mitre Edge

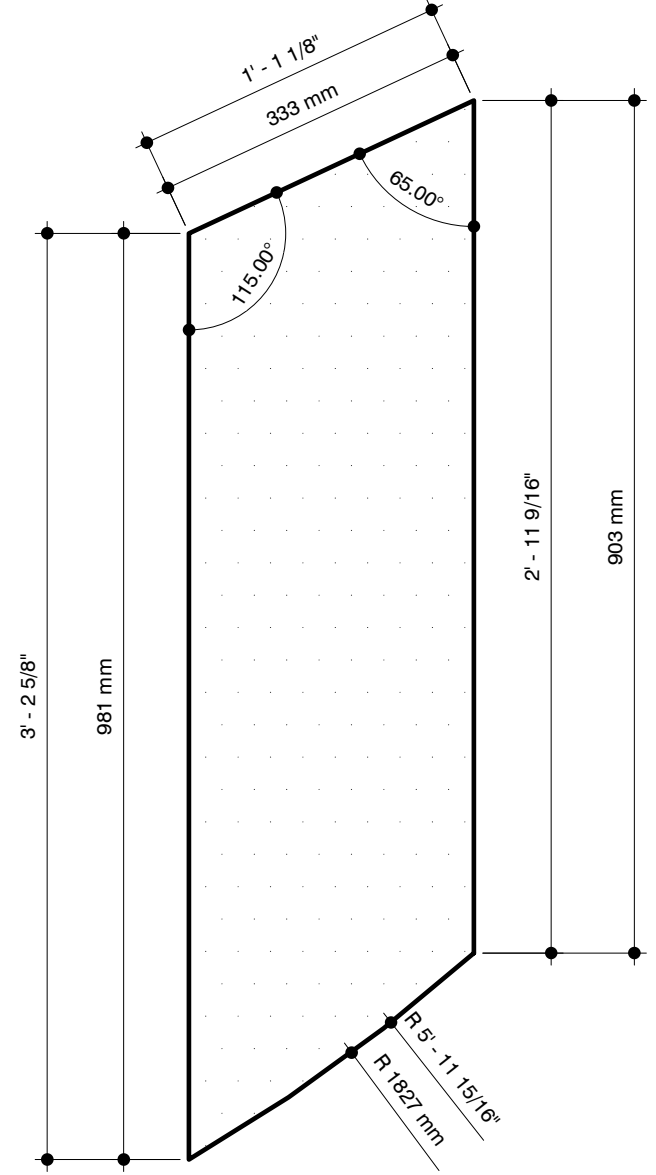

Stone Project Example

6250 Westpark Suite 218 Houston Texas 77057

Date: 02/23/09

Material: Rajah Black Granite

Finish: Polished

Thickness: 2cm

Ticket Number: **TC20**

Mark	Stone Type	Quantity	Area	
			Imperial	Metric
C29	ST-3	1	3.201 SF	0.297 m ²

Abbreviations
 FE - Finished Edge QME - Quirk Mitre Edge

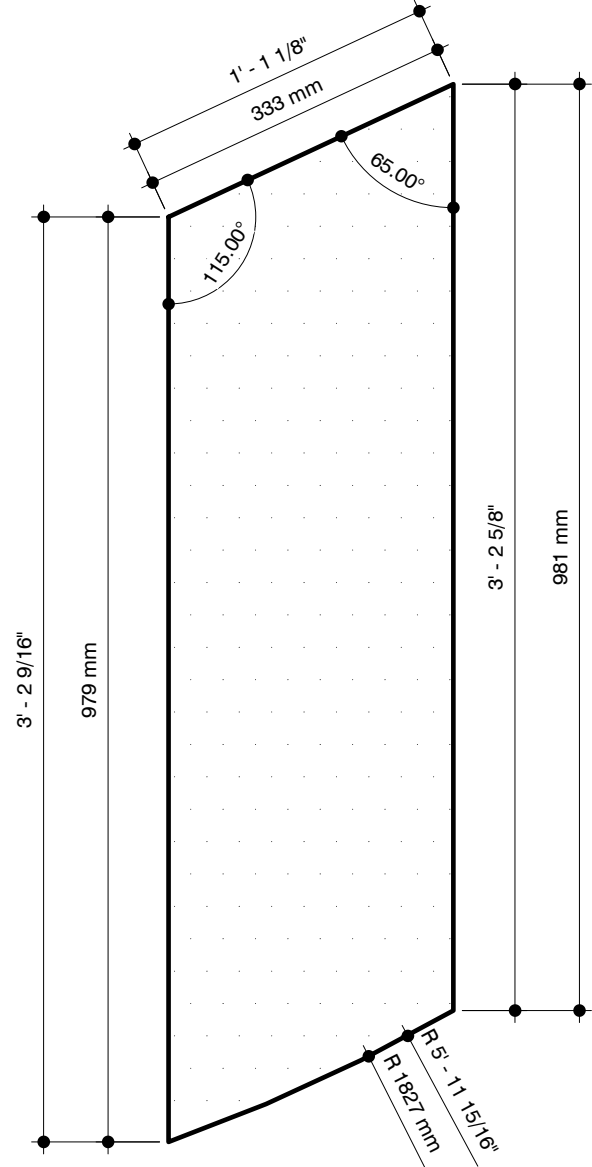

Stone Project Example

6250 Westpark Suite 218 Houston Texas 77057

Date: 02/23/09	Material: Rajah Black Granite	Finish: Polished	Thickness: 2cm	Ticket Number: TC21
----------------	-------------------------------	------------------	----------------	----------------------------

Mark	Stone Type	Quantity	Area	
			Imperial	Metric
C30	ST-3	1	3.093 SF	0.287 m ²

Abbreviations
 FE - Finished Edge QME - Quirk Mitre Edge

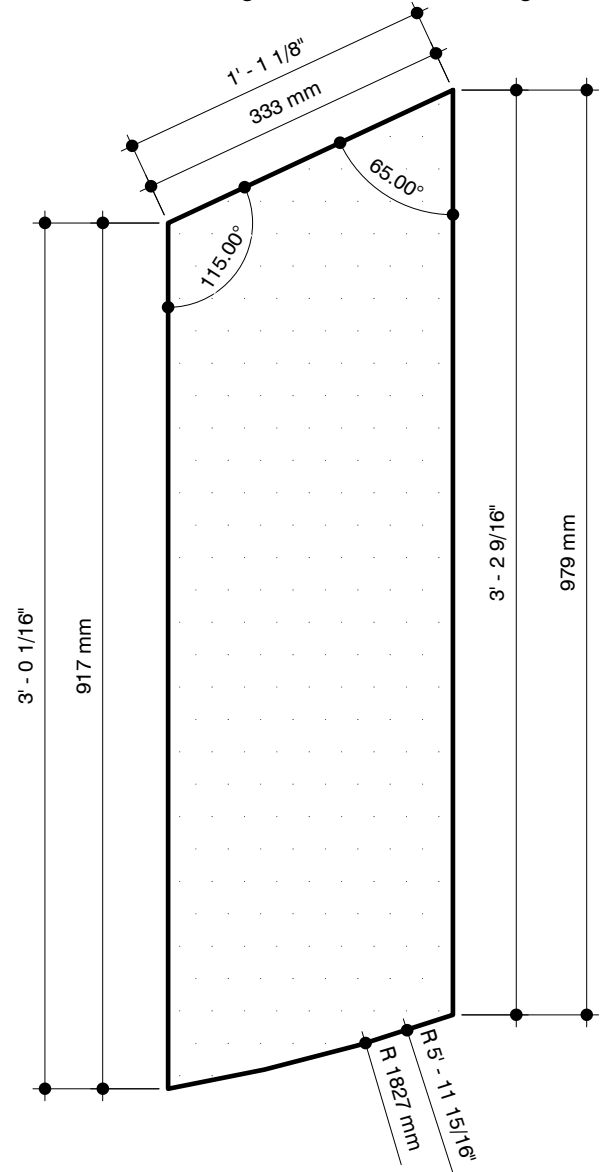

Stone Project Example

6250 Westpark Suite 218 Houston Texas 77057

Date: 02/23/09	Material: Rajah Black Granite	Finish: Polished	Thickness: 2cm	Ticket Number: TC22
----------------	-------------------------------	------------------	----------------	----------------------------

Mark	Stone Type	Quantity	Area	
			Imperial	Metric
C32	ST-3	1	0.977 SF	0.091 m ²

Abbreviations
 FE - Finished Edge QME - Quirk Mitre Edge

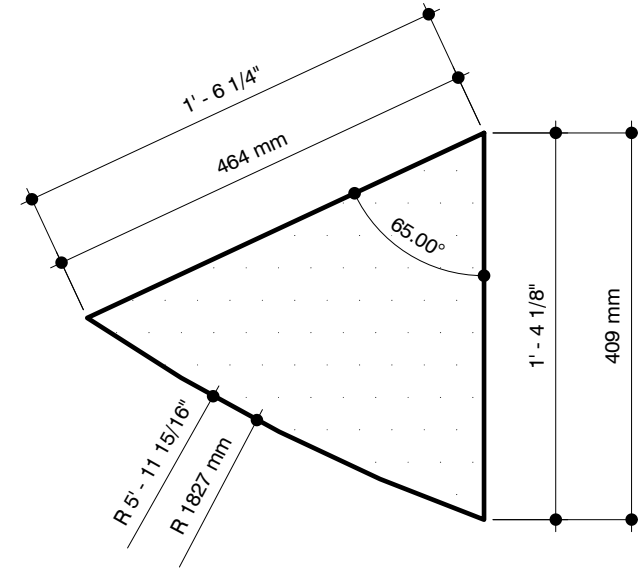

Stone Project Example

6250 Westpark Suite 218 Houston Texas 77057

Date: 02/23/09

Material: Rajah Black Granite

Finish: Polished

Thickness: 2cm

Ticket Number: **TC23**

Mark	Stone Type	Quantity	Area	
			Imperial	Metric
C33	ST-3	1	1.708 SF	0.159 m ²

Abbreviations
 FE - Finished Edge QME - Quirk Mitre Edge

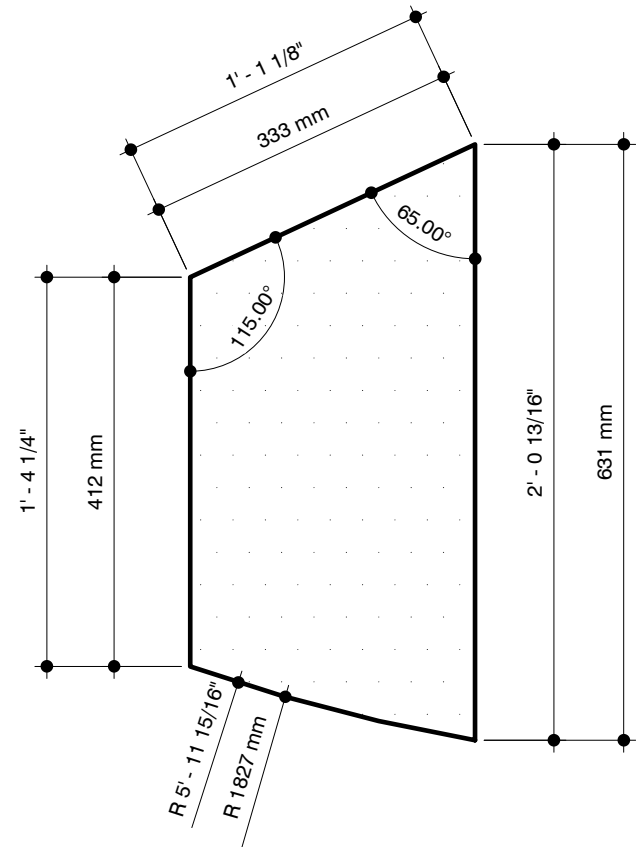

Stone Project Example

6250 Westpark Suite 218 Houston Texas 77057

Date: 02/23/09

Material: Rajah Black Granite

Finish: Polished

Thickness: 2cm

Ticket Number: **TC24**

Mark	Stone Type	Quantity	Area	
			Imperial	Metric
C34	ST-3	1	1.707 SF	0.159 m ²

Abbreviations
 FE - Finished Edge QME - Quirk Mitre Edge

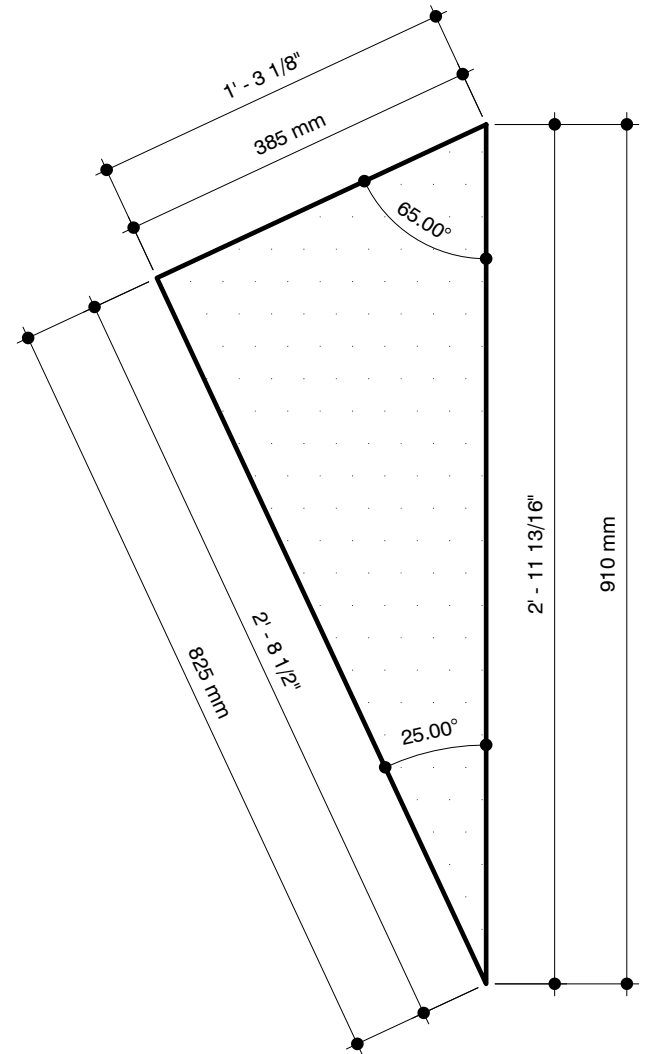

Stone Project Example

6250 Westpark Suite 218 Houston Texas 77057

Date: 02/23/09	Material: Rajah Black Granite	Finish: Polished	Thickness: 2cm	Ticket Number: TC25
----------------	-------------------------------	------------------	----------------	----------------------------

Mark	Stone Type	Quantity	Area	
			Imperial	Metric
C36	ST-3	1	1.859 SF	0.173 m ²

Abbreviations
 FE - Finished Edge QME - Quirk Mitre Edge

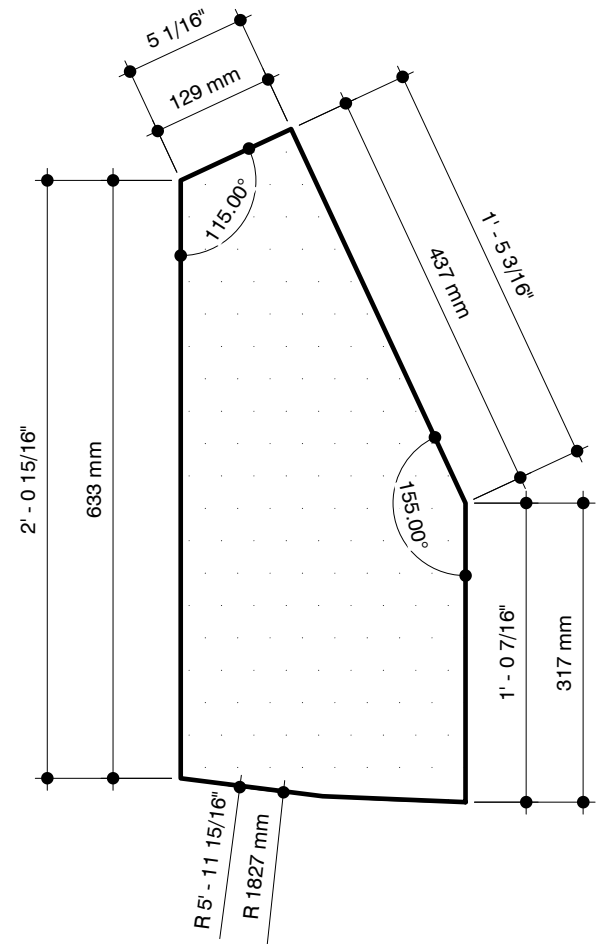

Stone Project Example

6250 Westpark Suite 218 Houston Texas 77057

Date: 02/23/09

Material: Rajah Black Granite

Finish: Polished

Thickness: 2cm

Ticket Number: **TC26**

Mark	Stone Type	Quantity	Area	
			Imperial	Metric
C38	ST-3	1	0.238 SF	0.022 m ²

Abbreviations
 FE - Finished Edge QME - Quirk Mitre Edge

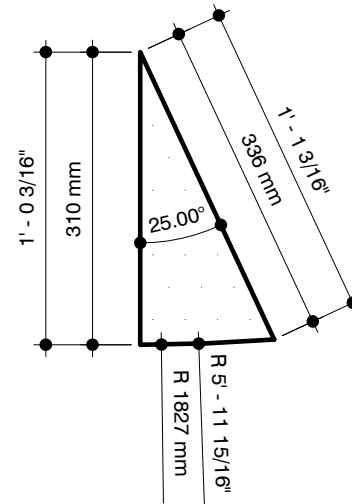

Stone Project Example

6250 Westpark Suite 218 Houston Texas 77057

Date: 02/23/09

Material: Rajah Black Granite

Finish: Polished

Thickness: 2cm

Ticket Number: **TC27**

Mark	Stone Type	A		B		Quantity	Area	
		Imperial	Metric	Imperial	Metric		Imperial	Metric
C39	ST-3	1' - 11 7/8"	606 mm	1' - 0 3/8"	314 mm	60	123.105 SF	11.437 m ²
C40	ST-3	1' - 11 7/8"	606 mm	1' - 0 1/4"	311 mm	7	14.217 SF	1.321 m ²
C41	ST-3	1' - 11 3/4"	603 mm	1' - 0 3/8"	314 mm	15	30.615 SF	2.844 m ²
C42	ST-3	1' - 11 3/4"	603 mm	1' - 0 1/4"	311 mm	1	2.020 SF	0.188 m ²
C43	ST-3	2' - 8 1/2"	825 mm	1' - 0 3/8"	314 mm	24	66.999 SF	6.224 m ²
C44	ST-3	2' - 8 1/2"	825 mm	11 1/4"	286 mm	1	2.539 SF	0.236 m ²
C45	ST-3	2' - 8 1/2"	825 mm	1' - 3 1/2"	394 mm	1	3.497 SF	0.325 m ²
C46	ST-3	1' - 3 7/8"	403 mm	9"	228 mm	1	0.989 SF	0.092 m ²
C47	ST-3	1' - 11 3/4"	603 mm	9"	228 mm	1	1.479 SF	0.137 m ²
C48	ST-3	2' - 9 3/8"	848 mm	1' - 0 11/16"	322 mm	1	2.934 SF	0.273 m ²
C49	ST-3	2' - 9 3/8"	848 mm	1' - 0"	305 mm	1	2.787 SF	0.259 m ²
C50	ST-3	2' - 9 3/8"	848 mm	1' - 0 3/4"	323 mm	6	17.696 SF	1.644 m ²
C51	ST-3	2' - 9 3/8"	848 mm	1' - 0 7/16"	316 mm	4	11.515 SF	1.070 m ²
C52	ST-3	2' - 9 3/8"	848 mm	1' - 1 1/8"	333 mm	24	72.912 SF	6.774 m ²
C53	ST-3	2' - 9 3/8"	848 mm	1' - 1 1/16"	331 mm	4	12.094 SF	1.124 m ²
C54	ST-3	2' - 9 3/8"	848 mm	11 3/16"	284 mm	2	5.185 SF	0.482 m ²
C55	ST-3	2' - 9 3/8"	848 mm	11 7/8"	302 mm	8	22.016 SF	2.045 m ²
C56	ST-3	2' - 7 13/16"	808 mm	11 11/16"	297 mm	2	5.164 SF	0.480 m ²
C57	ST-3	2' - 7 13/16"	808 mm	11 7/8"	302 mm	27	70.833 SF	6.581 m ²
C58	ST-3	2' - 7 13/16"	808 mm	10 5/16"	262 mm	8	18.226 SF	1.693 m ²
C59	ST-3	2' - 7 13/16"	808 mm	10 3/8"	264 mm	8	18.336 SF	1.704 m ²
C60	ST-3	1' - 8 13/16"	529 mm	9 1/4"	235 mm	6	8.021 SF	0.745 m ²
C61	ST-3	1' - 11 7/8"	606 mm	1' - 0 3/16"	310 mm	1	2.021 SF	0.188 m ²
C62	ST-3	1' - 11 1/4"	591 mm	5 3/4"	146 mm	10	9.284 SF	0.862 m ²
C63	ST-3	1' - 11 7/8"	606 mm	11 7/8"	302 mm	13	25.595 SF	2.378 m ²
C64	ST-3	1' - 11 7/8"	606 mm	11 3/4"	298 mm	3	5.844 SF	0.543 m ²
C65	ST-3	1' - 11 7/8"	606 mm	1' - 1 5/16"	338 mm	1	2.207 SF	0.205 m ²
C66	ST-3	2' - 7 13/16"	808 mm	11 3/4"	298 mm	1	2.596 SF	0.241 m ²
C67	ST-3	2' - 2 5/8"	676 mm	11 7/8"	302 mm	4	8.783 SF	0.816 m ²
C68	ST-3	3' - 5 3/4"	1060 mm	10"	254 mm	2	5.799 SF	0.539 m ²
C69	ST-3	1' - 8 13/16"	529 mm	2 5/8"	67 mm	2	0.759 SF	0.070 m ²
Grand total						249	576.067 SF	53.518 m ²

Abbreviations
FE - Finished Edge QME - Quirk Mitre Edge

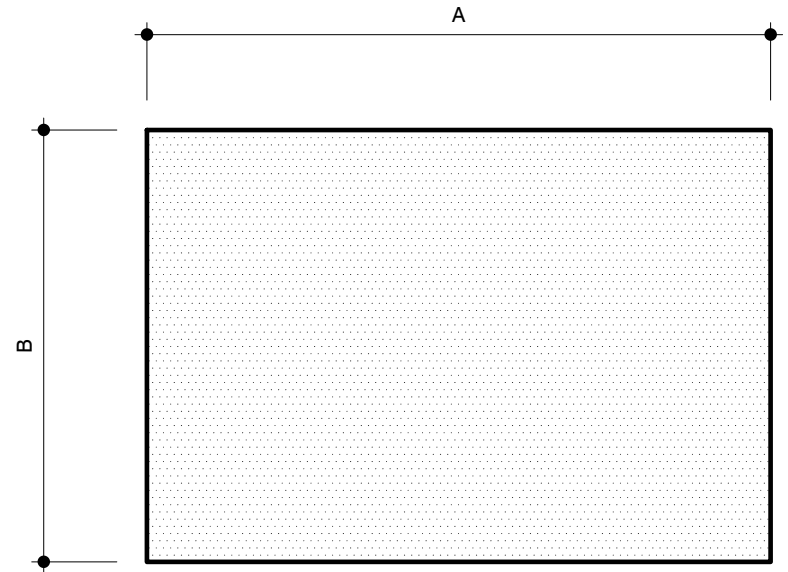

Stone Project Example

6250 Westpark Suite 218 Houston Texas 77057

Date: 02/15/09

Material: Rajah Black Granite

Finish: Polished

Thickness: 2cm

Ticket Number: **TC28**

Mark	Stone Type	A		B		Quantity	Area	
		Imperial	Metric	Imperial	Metric		Imperial	Metric
D15	ST-4	1' - 11 7/8"	606 mm	2' - 1 1/2"	648 mm	7	29.595 SF	2.749 m ²
D16	ST-4	1' - 11 7/8"	606 mm	2' - 1 7/16"	646 mm	7	29.523 SF	2.743 m ²
D17	ST-4	1' - 11 7/8"	606 mm	2' - 1 3/4"	654 mm	7	29.885 SF	2.776 m ²
D18	ST-4	1' - 11 7/8"	606 mm	2' - 2 13/16"	681 mm	7	31.118 SF	2.891 m ²
D19	ST-4	2' - 0 11/16"	626 mm	2' - 1 1/2"	648 mm	1	4.368 SF	0.406 m ²
D20	ST-4	2' - 0 11/16"	626 mm	2' - 1 7/16"	646 mm	1	4.357 SF	0.405 m ²
D21	ST-4	2' - 0 11/16"	626 mm	2' - 1 3/4"	654 mm	1	4.410 SF	0.410 m ²
D22	ST-4	2' - 0 11/16"	626 mm	2' - 2 13/16"	681 mm	1	4.592 SF	0.427 m ²
D25	ST-4	1' - 11 9/16"	598 mm	2' - 2 11/16"	678 mm	6	26.201 SF	2.434 m ²
D26	ST-4	1' - 11 9/16"	598 mm	2' - 4 1/16"	713 mm	6	27.551 SF	2.560 m ²
D31	ST-4	1' - 10 7/8"	581 mm	2' - 1 1/2"	648 mm	1	4.051 SF	0.376 m ²
D32	ST-4	1' - 10 7/8"	581 mm	2' - 1 7/16"	646 mm	1	4.041 SF	0.375 m ²
D33	ST-4	1' - 10 7/8"	581 mm	2' - 1 3/4"	654 mm	1	4.090 SF	0.380 m ²
D34	ST-4	1' - 10 7/8"	581 mm	2' - 2 13/16"	681 mm	1	4.259 SF	0.396 m ²
D41	ST-4	2' - 2 3/8"	669 mm	2' - 2 11/16"	678 mm	1	4.884 SF	0.454 m ²
D42	ST-4	2' - 2 3/8"	669 mm	2' - 4 1/16"	713 mm	1	5.135 SF	0.477 m ²
D43	ST-4	2' - 1 7/16"	646 mm	2' - 2 11/16"	678 mm	5	23.572 SF	2.190 m ²
D44	ST-4	2' - 1 7/16"	646 mm	2' - 4 1/16"	713 mm	5	24.786 SF	2.303 m ²
D45	ST-4	2' - 1 3/8"	645 mm	2' - 2 11/16"	678 mm	1	4.703 SF	0.437 m ²
D46	ST-4	2' - 1 3/8"	645 mm	2' - 4 1/16"	713 mm	1	4.945 SF	0.459 m ²
D47	ST-4	1' - 11 11/16"	602 mm	2' - 2 11/16"	678 mm	5	21.950 SF	2.039 m ²
D48	ST-4	1' - 11 11/16"	602 mm	2' - 4 1/16"	713 mm	5	23.081 SF	2.144 m ²
D51	ST-4	1' - 11 11/16"	602 mm	2' - 1 3/16"	640 mm	5	20.716 SF	1.925 m ²
D52	ST-4	1' - 11 11/16"	602 mm	2' - 1 3/4"	654 mm	5	21.179 SF	1.968 m ²
D53	ST-4	1' - 11 11/16"	602 mm	2' - 1 7/16"	646 mm	5	20.922 SF	1.944 m ²
D57	ST-4	1' - 11 11/16"	602 mm	2' - 1 1/2"	648 mm	5	20.973 SF	1.948 m ²
D62	ST-4	2' - 0 7/8"	632 mm	2' - 1 1/2"	648 mm	7	30.835 SF	2.865 m ²
D63	ST-4	1' - 3"	381 mm	2' - 1 1/2"	648 mm	1	2.656 SF	0.247 m ²
D65	ST-4	2' - 0 7/8"	632 mm	2' - 1 7/16"	646 mm	7	30.759 SF	2.858 m ²
D66	ST-4	1' - 3"	381 mm	2' - 1 7/16"	646 mm	1	2.650 SF	0.246 m ²
D68	ST-4	2' - 0 7/8"	632 mm	2' - 1 3/4"	654 mm	7	31.137 SF	2.893 m ²
D69	ST-4	1' - 3"	381 mm	2' - 1 3/4"	654 mm	1	2.682 SF	0.249 m ²
D71	ST-4	2' - 0 7/8"	632 mm	2' - 1 3/16"	640 mm	7	30.457 SF	2.830 m ²
D72	ST-4	1' - 3"	381 mm	2' - 1 3/16"	640 mm	1	2.624 SF	0.244 m ²
D74	ST-4	2' - 0 7/8"	632 mm	2' - 2 11/16"	678 mm	9	41.491 SF	3.855 m ²
D77	ST-4	2' - 0 7/8"	632 mm	2' - 4 1/16"	713 mm	11	53.324 SF	4.954 m ²
D79	ST-4	1' - 9 7/8"	556 mm	2' - 4 1/16"	713 mm	1	4.263 SF	0.396 m ²
Grand total						145	637.764 SF	59.250 m ²

Abbreviations
FE - Finished Edge QME - Quirk Mitre Edge

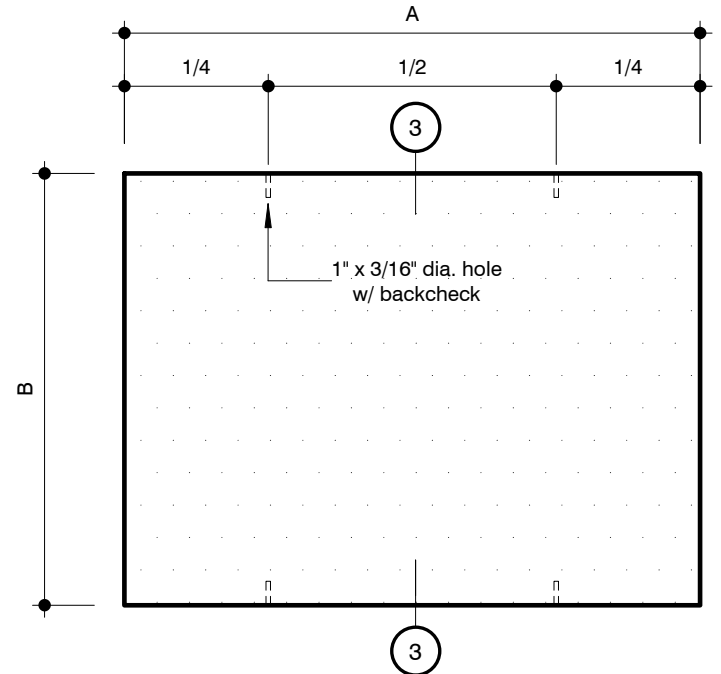

Stone Project Example

6250 Westpark Suite 218 Houston Texas 77057

Date: 02/13/09

Material: Porto Granite

Finish: Polished

Thickness: 2cm

Ticket Number: **TD1**

Mark	Stone Type	A		B		Quantity	Area	
		Imperial	Metric	Imperial	Metric		Imperial	Metric
D80	ST-4	2' - 1 13/16"	655 mm	2' - 2 11/16"	678 mm	1	4.779 SF	0.444 m ²
D82	ST-4	2' - 1 13/16"	655 mm	2' - 4 1/16"	713 mm	1	5.026 SF	0.467 m ²
D88	ST-4	5' - 0 13/16"	1544 mm	3' - 1 1/16"	941 mm	1	15.637 SF	1.453 m ²
D89	ST-4	5' - 0 13/16"	1544 mm	2' - 1 3/8"	645 mm	2	21.425 SF	1.990 m ²
D90	ST-4	5' - 0 13/16"	1544 mm	1' - 11 3/8"	594 mm	1	9.868 SF	0.917 m ²
D94	ST-4	5' - 0 13/16"	1544 mm	2' - 1 9/16"	650 mm	1	10.802 SF	1.004 m ²
D96	ST-4	4' - 5 5/8"	1362 mm	2' - 4 1/16"	712 mm	2	20.886 SF	1.940 m ²
D97	ST-4	4' - 5 5/8"	1362 mm	2' - 1 3/8"	645 mm	16	151.193 SF	14.046 m ²
D98	ST-4	4' - 5 5/8"	1362 mm	2' - 1 9/16"	650 mm	8	76.225 SF	7.082 m ²
D99	ST-4	4' - 5 5/8"	1362 mm	3' - 1 1/16"	941 mm	8	110.346 SF	10.251 m ²
D100	ST-4	4' - 5 5/8"	1362 mm	2' - 8 11/16"	831 mm	2	24.366 SF	2.264 m ²
D101	ST-4	4' - 5 5/8"	1362 mm	3' - 1 3/8"	950 mm	2	27.842 SF	2.587 m ²
D102	ST-4	4' - 5 5/8"	1362 mm	3' - 5 3/8"	1051 mm	2	30.816 SF	2.863 m ²
D103	ST-4	4' - 4 1/8"	1324 mm	3' - 1 1/16"	941 mm	2	26.813 SF	2.491 m ²
D104	ST-4	4' - 4 1/8"	1324 mm	2' - 1 3/8"	645 mm	4	36.738 SF	3.413 m ²
D105	ST-4	4' - 4 1/8"	1324 mm	2' - 1 9/16"	650 mm	2	18.522 SF	1.721 m ²
D106	ST-4	4' - 4 1/8"	1324 mm	3' - 5 3/8"	1051 mm	2	29.952 SF	2.783 m ²
D122	ST-4	1' - 11 11/16"	602 mm	2' - 1 3/8"	645 mm	4	16.696 SF	1.551 m ²
D123	ST-4	1' - 11 7/8"	606 mm	2' - 1 3/8"	645 mm	56	235.600 SF	21.888 m ²
D124	ST-4	1' - 11 11/16"	602 mm	2' - 1 7/16"	646 mm	8	33.475 SF	3.110 m ²
D125	ST-4	1' - 11 11/16"	602 mm	2' - 1 1/2"	648 mm	4	16.779 SF	1.559 m ²
D126	ST-4	1' - 11 7/8"	606 mm	2' - 1 7/16"	646 mm	100	421.750 SF	39.182 m ²
D127	ST-4	1' - 11 7/8"	606 mm	2' - 1 1/2"	648 mm	56	236.760 SF	21.996 m ²
D128	ST-4	1' - 11 11/16"	602 mm	3' - 1"	940 mm	4	24.345 SF	2.262 m ²
D129	ST-4	1' - 11 7/8"	606 mm	3' - 1"	940 mm	15	92.018 SF	8.549 m ²
D133	ST-4	1' - 11 7/8"	606 mm	3' - 1"	940 mm	2	12.269 SF	1.140 m ²
D139	ST-4	1' - 6 7/16"	468 mm	2' - 1 3/8"	645 mm	4	12.996 SF	1.207 m ²
D140	ST-4	1' - 6 7/16"	468 mm	2' - 1 7/16"	646 mm	6	19.542 SF	1.815 m ²
D141	ST-4	1' - 6 7/16"	468 mm	2' - 1 1/2"	648 mm	4	13.060 SF	1.213 m ²
D142	ST-4	1' - 6 7/16"	468 mm	3' - 1"	940 mm	2	9.475 SF	0.880 m ²
D143	ST-4	1' - 6 3/8"	467 mm	2' - 1 3/8"	645 mm	2	6.476 SF	0.602 m ²
D144	ST-4	1' - 6 3/8"	467 mm	2' - 1 7/16"	646 mm	2	6.492 SF	0.603 m ²
D145	ST-4	1' - 6 3/8"	467 mm	2' - 1 1/2"	648 mm	2	6.508 SF	0.605 m ²
D146	ST-4	1' - 6 7/16"	468 mm	3' - 1"	940 mm	1	4.737 SF	0.440 m ²
D150	ST-4	1' - 6 7/8"	479 mm	3' - 1"	940 mm	6	29.099 SF	2.703 m ²
Grand total						335	1819.312 SF	169.020 m ²

Abbreviations
FE - Finished Edge QME - Quirk Mitre Edge

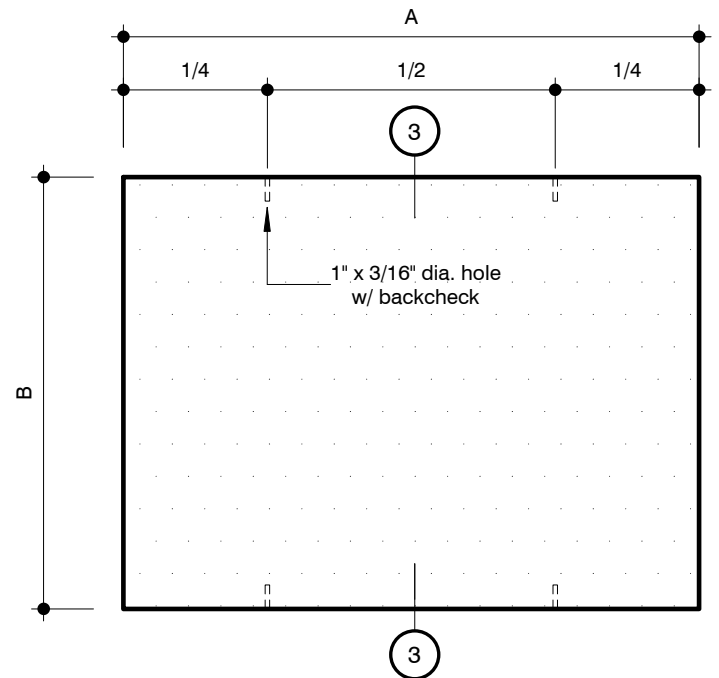

Stone Project Example

6250 Westpark Suite 218 Houston Texas 77057

Date: 02/19/09

Material: Porto Granite

Finish: Polished

Thickness: 2cm

Ticket Number: **TD2**

Mark	Stone Type	A		B		Quantity	Area	
		Imperial	Metric	Imperial	Metric		Imperial	Metric
D152	ST-4	1' - 2 1/4"	361 mm	2' - 1 3/8"	645 mm	1	2.507 SF	0.233 m ²
D153	ST-4	1' - 2 1/4"	361 mm	2' - 1 7/16"	646 mm	2	5.026 SF	0.467 m ²
D154	ST-4	1' - 2 1/4"	361 mm	2' - 1 1/2"	648 mm	1	2.519 SF	0.234 m ²
D155	ST-4	2' - 0"	610 mm	3' - 1"	940 mm	3	18.500 SF	1.719 m ²
D156	ST-4	1' - 6 3/16"	462 mm	2' - 1 3/8"	645 mm	1	3.205 SF	0.298 m ²
D160	ST-4	1' - 2 1/4"	361 mm	3' - 1"	940 mm	1	3.655 SF	0.340 m ²
D161	ST-4	1' - 11 7/8"	606 mm	3' - 1"	940 mm	31	190.171 SF	17.667 m ²
D162	ST-4	1' - 11 13/16"	605 mm	2' - 1 3/8"	645 mm	1	4.196 SF	0.390 m ²
D163	ST-4	1' - 11 13/16"	605 mm	2' - 1 7/16"	646 mm	2	8.413 SF	0.782 m ²
D164	ST-4	1' - 11 13/16"	605 mm	2' - 1 1/2"	648 mm	1	4.217 SF	0.392 m ²
D165	ST-4	1' - 11 13/16"	605 mm	3' - 1"	940 mm	1	6.118 SF	0.568 m ²
D166	ST-4	2' - 0 9/16"	624 mm	3' - 1"	940 mm	1	6.311 SF	0.586 m ²
D167	ST-4	2' - 0 9/16"	624 mm	1' - 7 3/8"	492 mm	1	3.305 SF	0.307 m ²
D168	ST-4	2' - 0 9/16"	624 mm	1' - 7 7/16"	494 mm	2	6.631 SF	0.616 m ²
D169	ST-4	2' - 0 9/16"	624 mm	1' - 7 1/2"	495 mm	1	3.326 SF	0.309 m ²
D170	ST-4	1' - 11 7/8"	606 mm	1' - 7 3/8"	492 mm	5	16.062 SF	1.492 m ²
D171	ST-4	1' - 11 7/8"	606 mm	1' - 7 7/16"	494 mm	10	32.227 SF	2.994 m ²
D172	ST-4	1' - 11 7/8"	606 mm	1' - 7 1/2"	495 mm	5	16.165 SF	1.502 m ²
D173	ST-4	2' - 0 5/8"	625 mm	1' - 7 3/8"	492 mm	1	3.313 SF	0.308 m ²
D174	ST-4	2' - 0 5/8"	625 mm	1' - 7 7/16"	494 mm	2	6.648 SF	0.618 m ²
D175	ST-4	2' - 0 5/8"	625 mm	1' - 7 1/2"	495 mm	1	3.335 SF	0.310 m ²
D176	ST-4	2' - 0 5/8"	625 mm	3' - 1"	940 mm	1	6.327 SF	0.588 m ²
D180	ST-4	2' - 3 5/8"	702 mm	3' - 1"	940 mm	1	7.098 SF	0.659 m ²
D182	ST-4	2' - 4 1/2"	724 mm	3' - 1"	940 mm	1	7.323 SF	0.680 m ²
D186	ST-4	1' - 11 3/4"	603 mm	2' - 1 3/8"	645 mm	1	4.185 SF	0.389 m ²
D187	ST-4	1' - 11 3/4"	603 mm	2' - 1 7/16"	646 mm	2	8.391 SF	0.780 m ²
D188	ST-4	1' - 11 3/4"	603 mm	2' - 1 1/2"	648 mm	1	4.206 SF	0.391 m ²
D189	ST-4	1' - 11 3/4"	603 mm	3' - 1"	940 mm	1	6.102 SF	0.567 m ²
D197	ST-4	1' - 4 3/8"	416 mm	3' - 1"	940 mm	1	4.207 SF	0.391 m ²
D201	ST-4	1' - 4 7/8"	429 mm	3' - 0"	914 mm	2	8.438 SF	0.784 m ²
D219	ST-4	1' - 11 13/16"	605 mm	2' - 1 3/8"	645 mm	1	4.196 SF	0.390 m ²
D220	ST-4	1' - 11 13/16"	605 mm	2' - 1 7/16"	646 mm	2	8.413 SF	0.782 m ²
D221	ST-4	1' - 11 13/16"	605 mm	2' - 1 1/2"	648 mm	1	4.217 SF	0.392 m ²
D222	ST-4	1' - 11 13/16"	605 mm	3' - 1"	940 mm	1	6.118 SF	0.568 m ²
D226	ST-4	1' - 11 7/8"	606 mm	3' - 1"	940 mm	2	12.269 SF	1.140 m ²
D231	ST-4	1' - 9 3/4"	552 mm	2' - 1 3/8"	645 mm	1	3.829 SF	0.356 m ²
Grand total						93	441.171 SF	40.986 m ²

Abbreviations
FE - Finished Edge QME - Quirk Mitre Edge

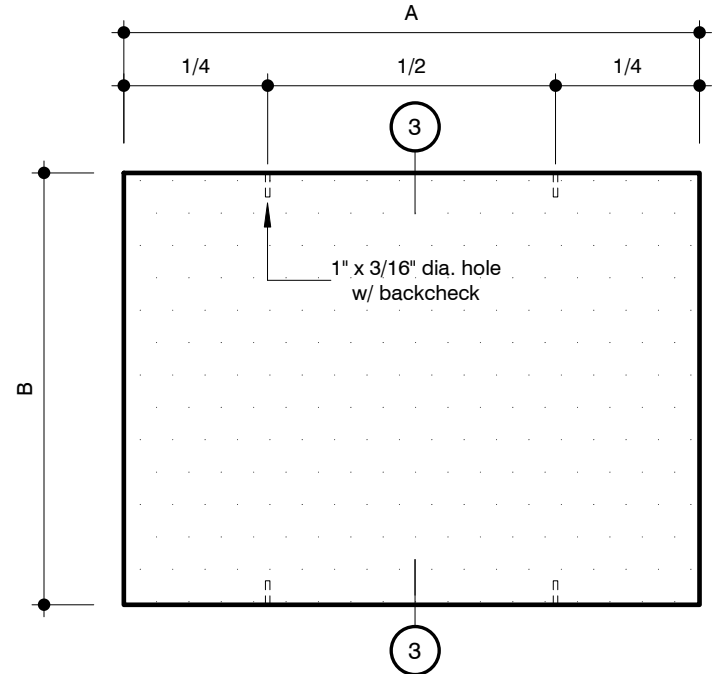

Stone Project Example

6250 Westpark Suite 218 Houston Texas 77057

Date: 02/26/09

Material: Porto Granite

Finish: Polished

Thickness: 2cm

Ticket Number: **TD3**

Mark	Stone Type	A		B		Quantity	Area	
		Imperial	Metric	Imperial	Metric		Imperial	Metric
D232	ST-4	1' - 9 3/4"	552 mm	2' - 1 7/16"	646 mm	2	7.676 SF	0.713 m ²
D233	ST-4	1' - 9 3/4"	552 mm	2' - 1 1/2"	648 mm	1	3.847 SF	0.357 m ²
D234	ST-4	1' - 9 3/4"	552 mm	3' - 1"	940 mm	1	5.583 SF	0.519 m ²
D239	ST-4	11 7/16"	291 mm	2' - 1 3/8"	645 mm	1	2.015 SF	0.187 m ²
D240	ST-4	11 7/16"	291 mm	2' - 1 7/16"	646 mm	2	4.041 SF	0.375 m ²
D241	ST-4	11 7/16"	291 mm	2' - 1 1/2"	648 mm	1	2.025 SF	0.188 m ²
D242	ST-4	11 7/16"	291 mm	3' - 1"	940 mm	1	2.939 SF	0.273 m ²
D247	ST-4	1' - 11 13/16"	605 mm	2' - 1 3/8"	645 mm	3	12.588 SF	1.169 m ²
D249	ST-4	1' - 11 13/16"	605 mm	2' - 1 7/16"	646 mm	3	12.619 SF	1.172 m ²
D251	ST-4	1' - 11 13/16"	605 mm	2' - 1 1/2"	648 mm	3	12.650 SF	1.175 m ²
D268	ST-4	1' - 6 3/8"	467 mm	2' - 3 3/16"	691 mm	2	6.938 SF	0.645 m ²
D276	ST-4	1' - 1 15/16"	353 mm	2' - 1 3/8"	645 mm	2	4.904 SF	0.456 m ²
D277	ST-4	1' - 1 15/16"	353 mm	2' - 1 7/16"	646 mm	2	4.916 SF	0.457 m ²
D278	ST-4	1' - 1 15/16"	353 mm	2' - 1 1/2"	648 mm	2	4.928 SF	0.458 m ²
D285	ST-4	2' - 0 3/4"	628 mm	1' - 7 3/8"	492 mm	1	3.327 SF	0.309 m ²
D286	ST-4	2' - 0 3/4"	628 mm	1' - 7 7/16"	494 mm	2	6.675 SF	0.620 m ²
D287	ST-4	2' - 0 3/4"	628 mm	1' - 7 1/2"	495 mm	1	3.348 SF	0.311 m ²
D291	ST-4	1' - 6 5/8"	473 mm	3' - 1"	940 mm	2	9.571 SF	0.889 m ²
D298	ST-4	11 7/16"	291 mm	3' - 1"	940 mm	1	2.939 SF	0.273 m ²
D341	ST-4	2' - 0"	610 mm	7 11/16"	195 mm	2	2.563 SF	0.238 m ²
D362	ST-4	1' - 1 15/16"	353 mm	2' - 3 3/16"	691 mm	2	5.254 SF	0.488 m ²
D366	ST-4	2' - 0"	610 mm	2' - 1 3/8"	645 mm	6	25.375 SF	2.357 m ²
D367	ST-4	2' - 0"	610 mm	2' - 1 7/16"	646 mm	7	29.677 SF	2.757 m ²
D368	ST-4	2' - 0"	610 mm	2' - 1 1/2"	648 mm	6	25.500 SF	2.369 m ²
D369	ST-4	1' - 6 7/16"	468 mm	2' - 1 3/8"	645 mm	1	3.249 SF	0.302 m ²
D370	ST-4	1' - 6 7/16"	468 mm	2' - 1 7/16"	646 mm	2	6.514 SF	0.605 m ²
D371	ST-4	1' - 6 7/16"	468 mm	2' - 1 1/2"	648 mm	1	3.265 SF	0.303 m ²
D373	ST-4	1' - 6 7/16"	468 mm	2' - 3 3/16"	691 mm	2	6.962 SF	0.647 m ²
D375	ST-4	2' - 0"	610 mm	2' - 3 3/16"	691 mm	3	13.594 SF	1.263 m ²
D381	ST-4	1' - 11 13/16"	605 mm	2' - 3 3/16"	691 mm	1	4.496 SF	0.418 m ²
D382	ST-4	1' - 11 7/8"	606 mm	2' - 3 3/16"	691 mm	12	54.092 SF	5.025 m ²
D384	ST-4	1' - 11 13/16"	605 mm	2' - 3 3/16"	691 mm	2	8.992 SF	0.835 m ²
Grand total						80	303.063 SF	28.155 m ²

Abbreviations
FE - Finished Edge QME - Quirk Mitre Edge

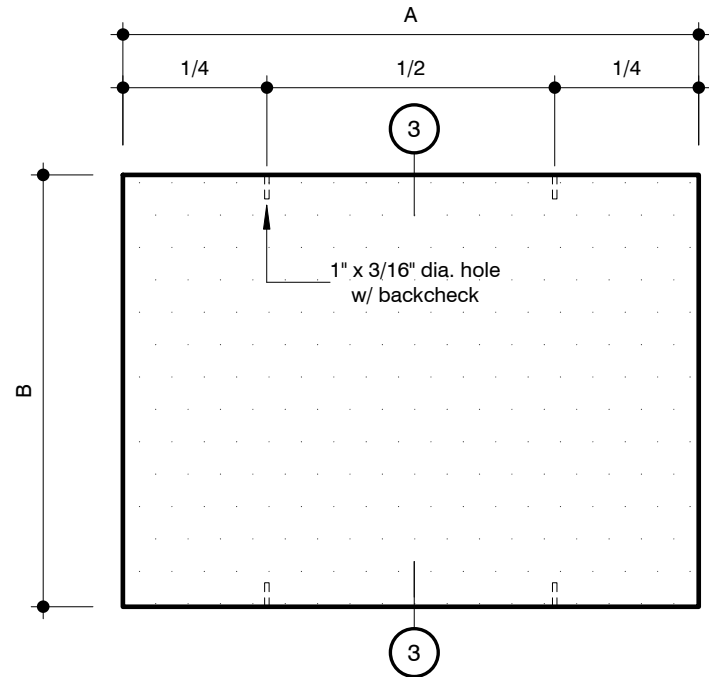

Stone Project Example

6250 Westpark Suite 218 Houston Texas 77057

Date: 02/26/09

Material: Porto Granite

Finish: Polished

Thickness: 2cm

Ticket Number: **TD4**

Mark	Stone Type	A		B		Quantity	Area	
		Imperial	Metric	Imperial	Metric		Imperial	Metric
D91	ST-4	1' - 6 9/16"	471 mm	2' - 1 3/8"	645 mm	2	6.531 SF	0.607 m ²
D92	ST-4	1' - 6 9/16"	471 mm	1' - 11 3/8"	594 mm	1	3.008 SF	0.279 m ²
D95	ST-4	1' - 6 9/16"	471 mm	2' - 1 9/16"	650 mm	1	3.293 SF	0.306 m ²
D130	ST-4	1' - 11 5/8"	600 mm	2' - 1 3/8"	645 mm	2	8.326 SF	0.774 m ²
D131	ST-4	1' - 11 5/8"	600 mm	2' - 1 7/16"	646 mm	4	16.693 SF	1.551 m ²
D132	ST-4	1' - 11 5/8"	600 mm	2' - 1 1/2"	648 mm	2	8.367 SF	0.777 m ²
D147	ST-4	1' - 6 5/8"	473 mm	2' - 1 3/8"	645 mm	12	39.384 SF	3.659 m ²
D148	ST-4	1' - 6 5/8"	473 mm	2' - 1 7/16"	646 mm	15	49.351 SF	4.585 m ²
D149	ST-4	1' - 6 5/8"	473 mm	2' - 1 1/2"	648 mm	12	39.578 SF	3.677 m ²
D177	ST-4	2' - 3 3/8"	695 mm	2' - 1 3/8"	645 mm	1	4.824 SF	0.448 m ²
D178	ST-4	2' - 3 3/8"	695 mm	2' - 1 7/16"	646 mm	2	9.672 SF	0.899 m ²
D179	ST-4	2' - 3 3/8"	695 mm	2' - 1 1/2"	648 mm	1	4.848 SF	0.450 m ²
D190	ST-4	2' - 0 1/8"	613 mm	2' - 1 3/8"	645 mm	1	4.251 SF	0.395 m ²
D191	ST-4	2' - 0 1/8"	613 mm	2' - 1 7/16"	646 mm	2	8.523 SF	0.792 m ²
D192	ST-4	2' - 0 1/8"	613 mm	2' - 1 1/2"	648 mm	1	4.272 SF	0.397 m ²
D193	ST-4	2' - 0 1/8"	613 mm	3' - 1"	940 mm	1	6.199 SF	0.576 m ²
D194	ST-4	1' - 4 1/8"	410 mm	2' - 1 3/8"	645 mm	1	2.841 SF	0.264 m ²
D195	ST-4	1' - 4 1/8"	410 mm	2' - 1 7/16"	646 mm	2	5.697 SF	0.529 m ²
D196	ST-4	1' - 4 1/8"	410 mm	2' - 1 1/2"	648 mm	1	2.855 SF	0.265 m ²
D198	ST-4	1' - 4 5/8"	422 mm	2' - 1 3/8"	645 mm	2	5.859 SF	0.544 m ²
D199	ST-4	1' - 4 5/8"	422 mm	2' - 1 7/16"	646 mm	4	11.747 SF	1.091 m ²
D200	ST-4	1' - 4 5/8"	422 mm	2' - 1 1/2"	648 mm	2	5.888 SF	0.547 m ²
D243	ST-4	2' - 0 3/16"	614 mm	2' - 1 3/8"	645 mm	1	4.262 SF	0.396 m ²
D244	ST-4	2' - 0 3/16"	614 mm	2' - 1 7/16"	646 mm	2	8.545 SF	0.794 m ²
D245	ST-4	2' - 0 3/16"	614 mm	2' - 1 1/2"	648 mm	1	4.283 SF	0.398 m ²
D246	ST-4	2' - 0 3/16"	614 mm	3' - 1"	940 mm	1	6.215 SF	0.577 m ²
D259	ST-4	11"	279 mm	2' - 1 3/8"	645 mm	2	3.877 SF	0.360 m ²
D260	ST-4	11"	279 mm	2' - 1 7/16"	646 mm	2	3.886 SF	0.361 m ²
D261	ST-4	11"	279 mm	2' - 1 1/2"	648 mm	2	3.896 SF	0.362 m ²
D262	ST-4	10 5/8"	270 mm	2' - 1 3/8"	645 mm	2	3.745 SF	0.348 m ²
D263	ST-4	10 5/8"	270 mm	2' - 1 7/16"	646 mm	2	3.754 SF	0.349 m ²
D264	ST-4	10 5/8"	270 mm	2' - 1 1/2"	648 mm	2	3.763 SF	0.350 m ²
D265	ST-4	11 5/8"	295 mm	2' - 1 3/8"	645 mm	2	4.097 SF	0.381 m ²
D266	ST-4	11 5/8"	295 mm	2' - 1 7/16"	646 mm	2	4.107 SF	0.382 m ²
D270	ST-4	9 3/4"	248 mm	2' - 2 1/16"	662 mm	6	10.588 SF	0.984 m ²
D279	ST-4	1' - 8 1/8"	511 mm	2' - 1 3/8"	645 mm	4	14.185 SF	1.318 m ²
D280	ST-4	1' - 8 1/8"	511 mm	2' - 1 7/16"	646 mm	4	14.220 SF	1.321 m ²
Grand total						107	345.432 SF	32.092 m ²

Abbreviations
FE - Finished Edge QME - Quirk Mitre Edge

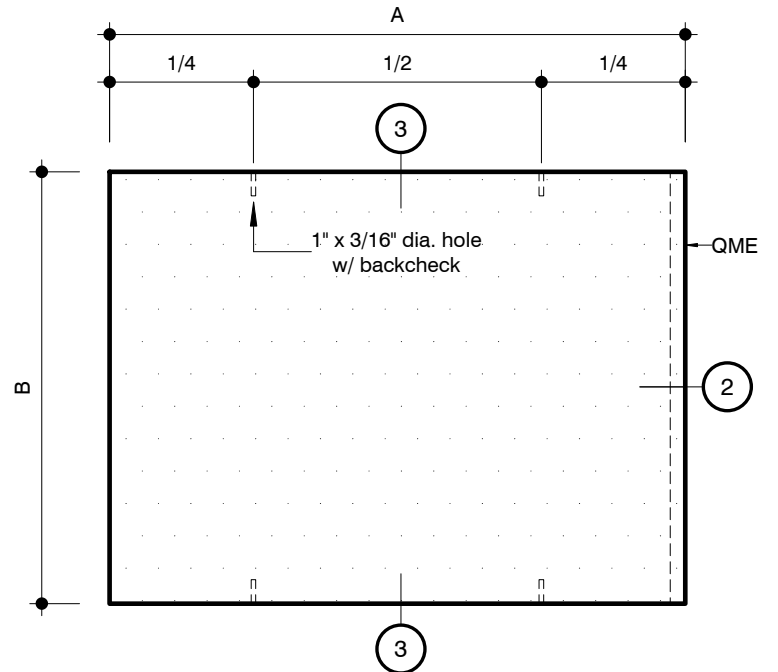

Stone Project Example

6250 Westpark Suite 218 Houston Texas 77057

Date: 02/15/09

Material: Porto Granite

Finish: Polished

Thickness: 2cm

Ticket Number: **TD5**

Mark	Stone Type	A		B		Quantity	Area	
		Imperial	Metric	Imperial	Metric		Imperial	Metric
D281	ST-4	1' - 8 1/8"	511 mm	2' - 1 1/2"	648 mm	4	14.255 SF	1.324 m ²
D282	ST-4	1' - 8 1/8"	511 mm	2' - 1 3/8"	645 mm	2	7.093 SF	0.659 m ²
D283	ST-4	1' - 8 1/8"	511 mm	2' - 1 7/16"	646 mm	2	7.110 SF	0.661 m ²
D284	ST-4	1' - 8 1/8"	511 mm	2' - 1 1/2"	648 mm	2	7.128 SF	0.662 m ²
D294	ST-4	9 3/4"	248 mm	2' - 1 3/8"	645 mm	12	20.617 SF	1.915 m ²
D295	ST-4	9 3/4"	248 mm	2' - 1 7/16"	646 mm	18	31.002 SF	2.880 m ²
D296	ST-4	9 3/4"	248 mm	2' - 1 1/2"	648 mm	12	20.719 SF	1.925 m ²
D360	ST-4	1' - 8 1/8"	511 mm	2' - 3 3/16"	691 mm	2	7.599 SF	0.706 m ²
D361	ST-4	1' - 8 1/8"	511 mm	2' - 3 3/16"	691 mm	4	15.199 SF	1.412 m ²
D363	ST-4	11 5/8"	295 mm	2' - 3 3/16"	691 mm	2	4.390 SF	0.408 m ²
D364	ST-4	10 5/8"	270 mm	2' - 3 3/16"	691 mm	2	4.012 SF	0.373 m ²
D365	ST-4	11"	279 mm	2' - 3 3/16"	691 mm	2	4.154 SF	0.386 m ²
D374	ST-4	1' - 6 5/8"	473 mm	2' - 3 3/16"	691 mm	3	10.549 SF	0.980 m ²
D377	ST-4	1' - 0 5/8"	321 mm	2' - 1 3/8"	645 mm	2	4.449 SF	0.413 m ²
D378	ST-4	1' - 0 5/8"	321 mm	2' - 1 7/16"	646 mm	2	4.460 SF	0.414 m ²
D379	ST-4	1' - 0 5/8"	321 mm	2' - 1 1/2"	648 mm	2	4.471 SF	0.415 m ²
D380	ST-4	1' - 0 5/8"	321 mm	2' - 3 3/16"	691 mm	2	4.767 SF	0.443 m ²
D2647	ST-4	11 5/8"	295 mm	2' - 1 1/2"	648 mm	2	4.117 SF	0.382 m ²

Grand total 77 176.092 SF 16.359 m²

Abbreviations
 FE - Finished Edge QME - Quirk Mitre Edge

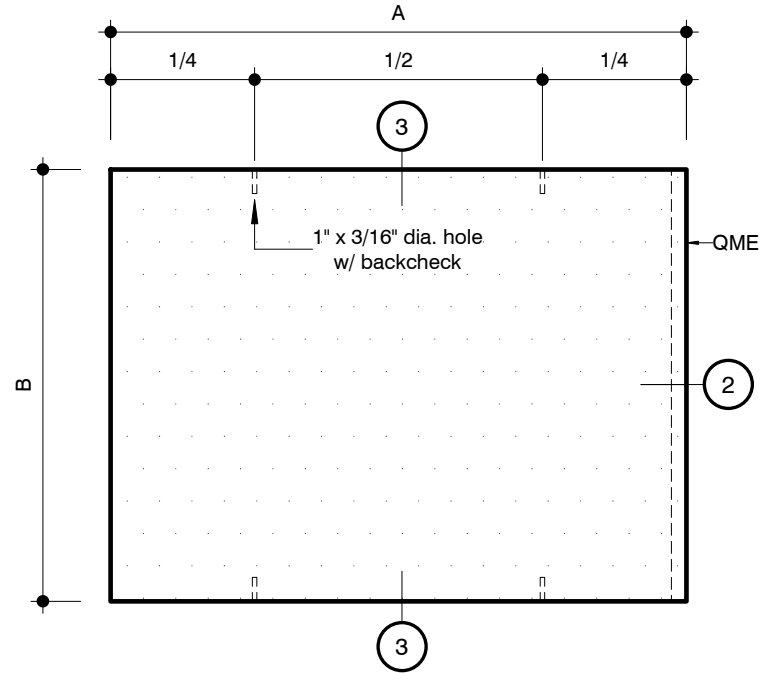

Stone Project Example

6250 Westpark Suite 218 Houston Texas 77057

Date: 02/26/09

Material: Porto Granite

Finish: Polished

Thickness: 2cm

Ticket Number: **TD6**

Mark	Stone Type	A		B		Quantity	Area	
		Imperial	Metric	Imperial	Metric		Imperial	Metric
D1	ST-4	2' - 1 1/16"	636 mm	2' - 1 1/2"	648 mm	2	8.868 SF	0.824 m ²
D2	ST-4	2' - 1 1/16"	636 mm	2' - 1 7/16"	646 mm	2	8.846 SF	0.822 m ²
D3	ST-4	2' - 1 1/16"	636 mm	2' - 1 3/4"	654 mm	1	4.477 SF	0.416 m ²
D7	ST-4	2' - 4 3/16"	716 mm	2' - 1 3/4"	654 mm	1	5.040 SF	0.468 m ²
D9	ST-4	2' - 4 3/16"	716 mm	2' - 1 1/2"	648 mm	2	9.983 SF	0.927 m ²
D35	ST-4	7 5/8"	194 mm	2' - 1 1/2"	648 mm	1	1.350 SF	0.125 m ²
D38	ST-4	7 5/8"	194 mm	2' - 1 7/16"	646 mm	1	1.347 SF	0.125 m ²
D39	ST-4	7 5/8"	194 mm	2' - 1 3/4"	654 mm	1	1.363 SF	0.127 m ²
D49	ST-4	1' - 11 11/16"	602 mm	2' - 2 11/16"	678 mm	1	4.390 SF	0.408 m ²
D50	ST-4	1' - 11 11/16"	602 mm	2' - 4 1/16"	713 mm	1	4.616 SF	0.429 m ²
D54	ST-4	1' - 11 11/16"	602 mm	2' - 1 7/16"	646 mm	1	4.184 SF	0.389 m ²
D55	ST-4	1' - 11 11/16"	602 mm	2' - 1 3/4"	654 mm	1	4.236 SF	0.394 m ²
D56	ST-4	1' - 11 11/16"	602 mm	2' - 1 3/16"	640 mm	1	4.143 SF	0.385 m ²
D58	ST-4	1' - 11 11/16"	602 mm	2' - 1 1/2"	648 mm	1	4.195 SF	0.390 m ²
D59	ST-4	1' - 0 7/16"	315 mm	2' - 1 7/16"	646 mm	1	2.192 SF	0.204 m ²
D60	ST-4	1' - 0 7/16"	315 mm	2' - 1 1/2"	648 mm	1	2.198 SF	0.204 m ²
D64	ST-4	1' - 7 1/2"	495 mm	2' - 1 1/2"	648 mm	1	3.448 SF	0.320 m ²
D67	ST-4	1' - 7 1/2"	495 mm	2' - 1 7/16"	646 mm	1	3.439 SF	0.320 m ²
D70	ST-4	1' - 7 1/2"	495 mm	2' - 1 3/4"	654 mm	1	3.481 SF	0.323 m ²
D73	ST-4	1' - 7 1/2"	495 mm	2' - 1 3/16"	640 mm	1	3.405 SF	0.316 m ²
D81	ST-4	1' - 0 7/16"	315 mm	2' - 1 3/4"	654 mm	1	2.219 SF	0.206 m ²
D83	ST-4	1' - 0 7/16"	315 mm	2' - 1 3/16"	640 mm	1	2.171 SF	0.202 m ²
D183	ST-4	2' - 4 1/4"	718 mm	2' - 1 7/16"	646 mm	2	9.981 SF	0.927 m ²
D184	ST-4	2' - 4 1/4"	718 mm	2' - 1 1/2"	648 mm	1	5.003 SF	0.465 m ²
D185	ST-4	2' - 4 1/4"	718 mm	2' - 1 5/16"	643 mm	1	4.966 SF	0.461 m ²
D223	ST-4	1' - 11 5/8"	600 mm	2' - 1 3/8"	645 mm	2	8.326 SF	0.774 m ²
D224	ST-4	1' - 11 5/8"	600 mm	2' - 1 7/16"	646 mm	4	16.693 SF	1.551 m ²
D225	ST-4	1' - 11 5/8"	600 mm	2' - 1 1/2"	648 mm	2	8.367 SF	0.777 m ²
D271	ST-4	1' - 4 7/8"	429 mm	2' - 1 3/8"	645 mm	2	5.947 SF	0.553 m ²
D272	ST-4	1' - 4 7/8"	429 mm	2' - 1 7/16"	646 mm	2	5.962 SF	0.554 m ²
D273	ST-4	1' - 4 7/8"	429 mm	2' - 1 1/2"	648 mm	2	5.977 SF	0.555 m ²
D288	ST-4	1' - 6 3/8"	467 mm	2' - 1 3/8"	645 mm	2	6.476 SF	0.602 m ²
D289	ST-4	1' - 6 3/8"	467 mm	2' - 1 7/16"	646 mm	4	12.984 SF	1.206 m ²
D290	ST-4	1' - 6 3/8"	467 mm	2' - 1 1/2"	648 mm	2	6.508 SF	0.605 m ²
Grand total						51	186.783 SF	17.353 m ²

Abbreviations
FE - Finished Edge QME - Quirk Mitre Edge

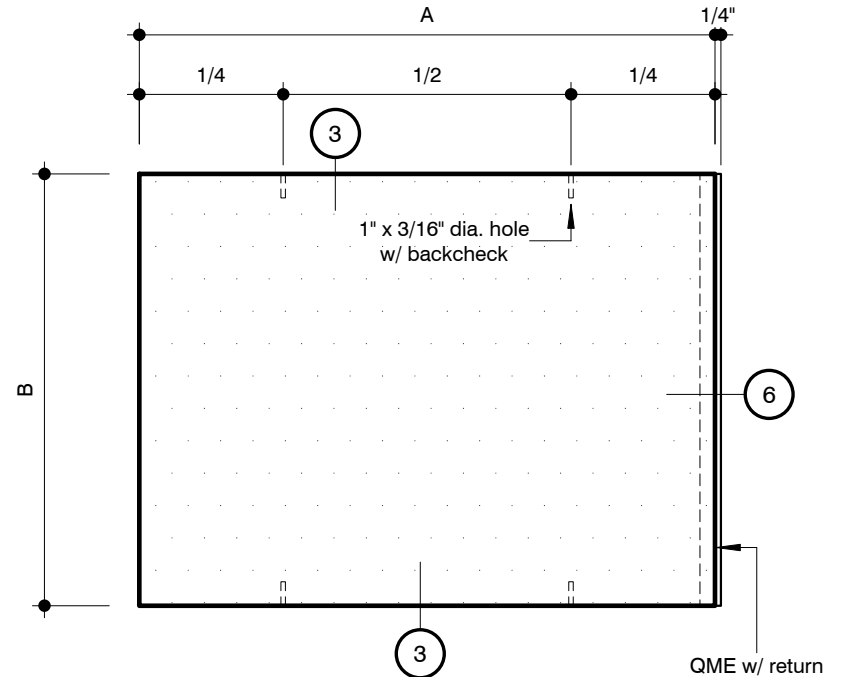

Stone Project Example

6250 Westpark Suite 218 Houston Texas 77057

Date: 02/15/09

Material: Porto Granite

Finish: Polished

Thickness: 2cm

Ticket Number: **TD7**

Mark	Stone Type	A		B		Quantity	Area	
		Imperial	Metric	Imperial	Metric		Imperial	Metric
D299	ST-4	11 3/16"	284 mm	2' - 1 7/16"	646 mm	2	3.953 SF	0.367 m ²
D300	ST-4	11 3/16"	284 mm	2' - 1 1/2"	648 mm	1	1.981 SF	0.184 m ²
D301	ST-4	11 3/16"	284 mm	2' - 1 3/8"	645 mm	1	1.971 SF	0.183 m ²
D302	ST-4	8 1/4"	210 mm	2' - 1 3/8"	645 mm	1	1.454 SF	0.135 m ²
D303	ST-4	8 1/4"	210 mm	2' - 1 7/16"	646 mm	2	2.915 SF	0.271 m ²
D304	ST-4	8 1/4"	210 mm	2' - 1 1/2"	648 mm	1	1.461 SF	0.136 m ²
D376	ST-4	1' - 4 7/8"	429 mm	2' - 3 3/16"	691 mm	2	6.372 SF	0.592 m ²
Grand total						10	20.107 SF	1.868 m ²

Abbreviations
 FE - Finished Edge QME - Quirk Mitre Edge

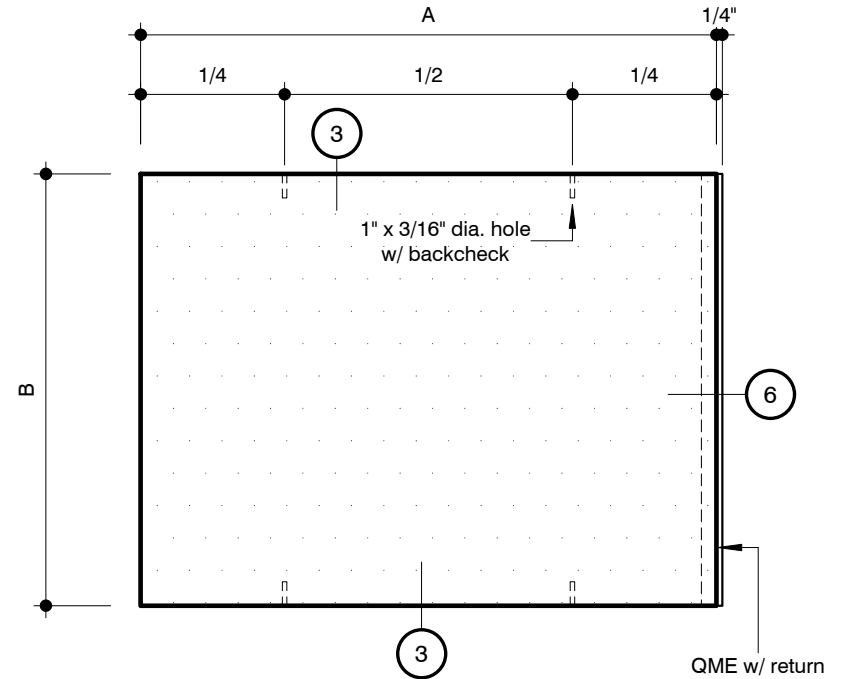

Stone Project Example

6250 Westpark Suite 218 Houston Texas 77057

Date: 02/26/09

Material: Porto Granite

Finish: Polished

Thickness: 2cm

Ticket Number: **TDS**

Mark	Stone Type	A		B		Quantity	Area	
		Imperial	Metric	Imperial	Metric		Imperial	Metric
D23	ST-4	1' - 11 9/16"	598 mm	1' - 5 1/8"	435 mm	6	16.813 SF	1.562 m ²
D40	ST-4	1' - 11 3/4"	603 mm	1' - 10 3/4"	578 mm	1	3.752 SF	0.349 m ²
D75	ST-4	2' - 0 7/8"	632 mm	2' - 2 5/16"	668 mm	1	4.545 SF	0.422 m ²
D292	ST-4	1' - 9 1/16"	535 mm	3' - 0 1/2"	927 mm	2	10.678 SF	0.992 m ²
Grand total						10	35.787 SF	3.325 m ²

Abbreviations
 FE - Finished Edge QME - Quirk Mitre Edge

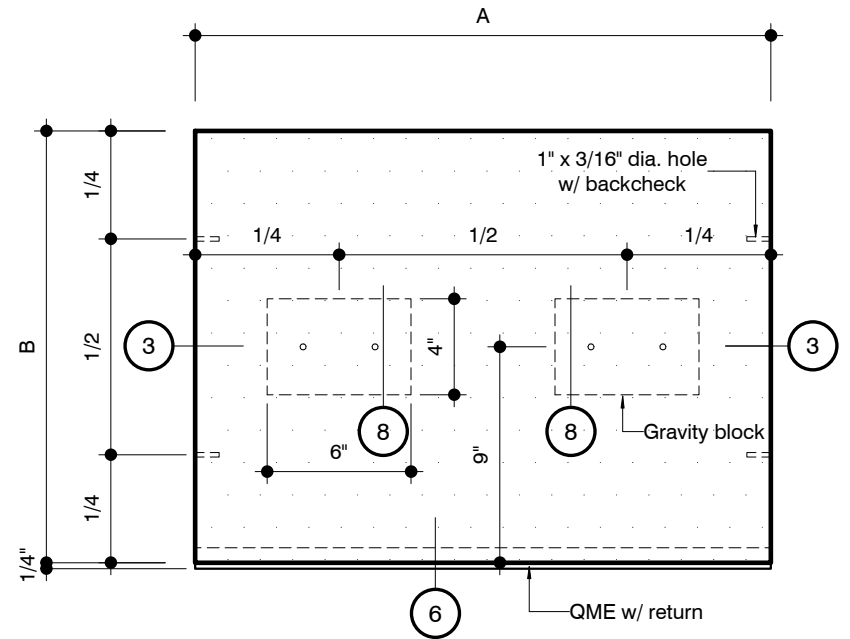

Stone Project Example

6250 Westpark Suite 218 Houston Texas 77057

Date: 02/15/09

Material: Porto Granite

Finish: Polished

Thickness: 2cm

Ticket Number: **TD9**

Mark	Stone Type	A		B		Quantity	Area	
		Imperial	Metric	Imperial	Metric		Imperial	Metric
D5	ST-4	1' - 11 5/16"	592 mm	1' - 10 1/4"	565 mm	2	7.204 SF	0.669 m ²
D227	ST-4	1' - 11 7/8"	606 mm	3' - 0 1/2"	927 mm	2	12.103 SF	1.124 m ²
D387	ST-4	1' - 7 9/16"	497 mm	3' - 0 1/2"	927 mm	1	4.959 SF	0.461 m ²
Grand total						5	24.266 SF	2.254 m ²

Abbreviations
 FE - Finished Edge QME - Quirk Mitre Edge

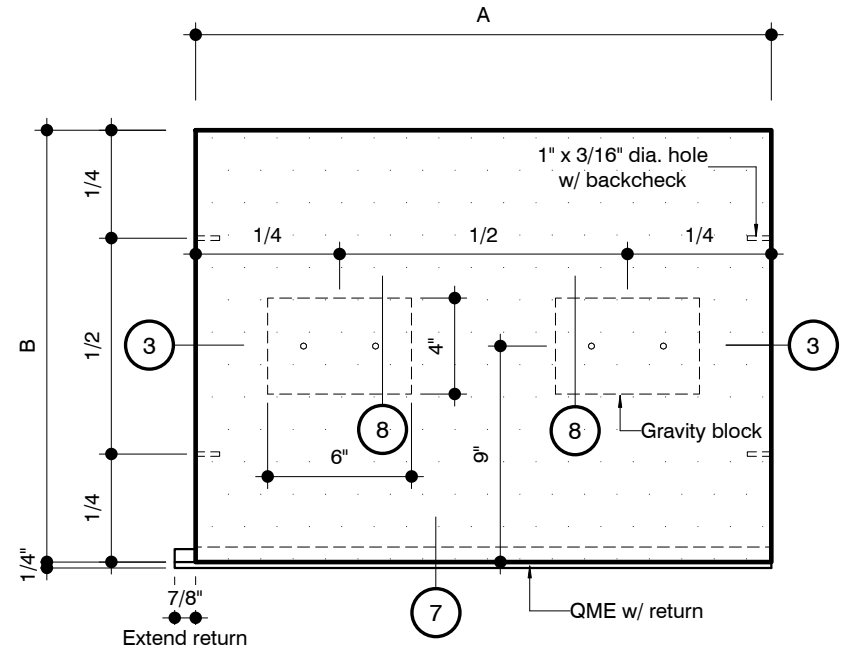

Stone Project Example

6250 Westpark Suite 218 Houston Texas 77057

Date: 02/15/09

Material: Porto Granite

Finish: Polished

Thickness: 2cm

Ticket Number: **TD10**

Mark	Stone Type	A		B		Quantity	Area	
		Imperial	Metric	Imperial	Metric		Imperial	Metric
D13	ST-4	1' - 11 5/16"	592 mm	1' - 10 1/4"	565 mm	2	7.204 SF	0.669 m ²
D181	ST-4	1' - 7 9/16"	497 mm	3' - 0 1/2"	927 mm	1	4.959 SF	0.461 m ²
D297	ST-4	1' - 11 7/8"	606 mm	3' - 0 1/2"	927 mm	1	6.052 SF	0.562 m ²
Grand total						4	18.214 SF	1.692 m ²

Abbreviations
 FE - Finished Edge QME - Quirk Mitre Edge

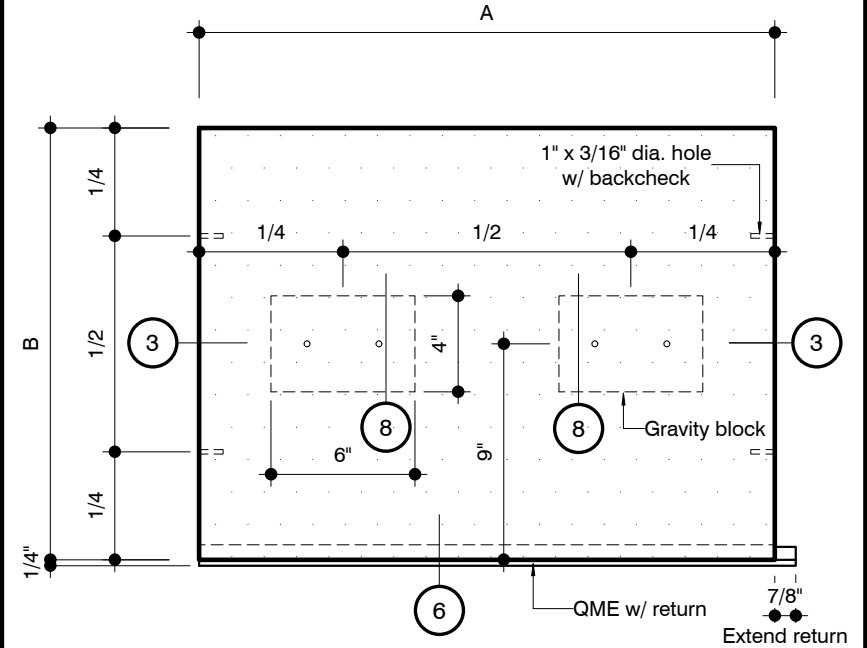

Stone Project Example

6250 Westpark Suite 218 Houston Texas 77057

Date: 02/15/09

Material: Porto Granite

Finish: Polished

Thickness: 2cm

Ticket Number: **TD11**

Mark	Stone Type	A		B		Quantity	Area	
		Imperial	Metric	Imperial	Metric		Imperial	Metric
D10	ST-4	2' - 4 3/16"	716 mm	2' - 1 3/4"	654 mm	1	5.040 SF	0.468 m ²
D11	ST-4	2' - 1 1/16"	636 mm	2' - 1 3/4"	654 mm	1	4.477 SF	0.416 m ²
Grand total						2	9.518 SF	0.884 m ²

Abbreviations
 FE - Finished Edge QME - Quirk Mitre Edge

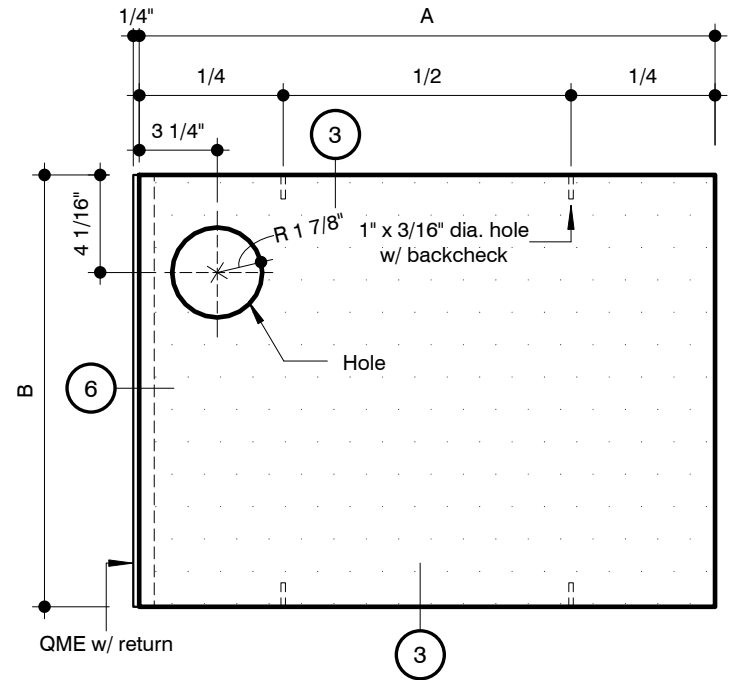

Stone Project Example

6250 Westpark Suite 218 Houston Texas 77057

Date: 02/18/09

Material: Porto Granite

Finish: Polished

Thickness: 2cm

Ticket Number: **TD12**

Mark	Stone Type	B		Quantity	Area	
		Imperial	Metric		Imperial	Metric
D4	ST-4	2' - 1 5/16"	642 mm	1	4.701 SF	0.437 m ²
D14	ST-4	2' - 4 7/16"	722 mm	1	5.288 SF	0.491 m ²
Grand total				2	9.989 SF	0.928 m ²

Abbreviations
 FE - Finished Edge QME - Quirk Mitre Edge

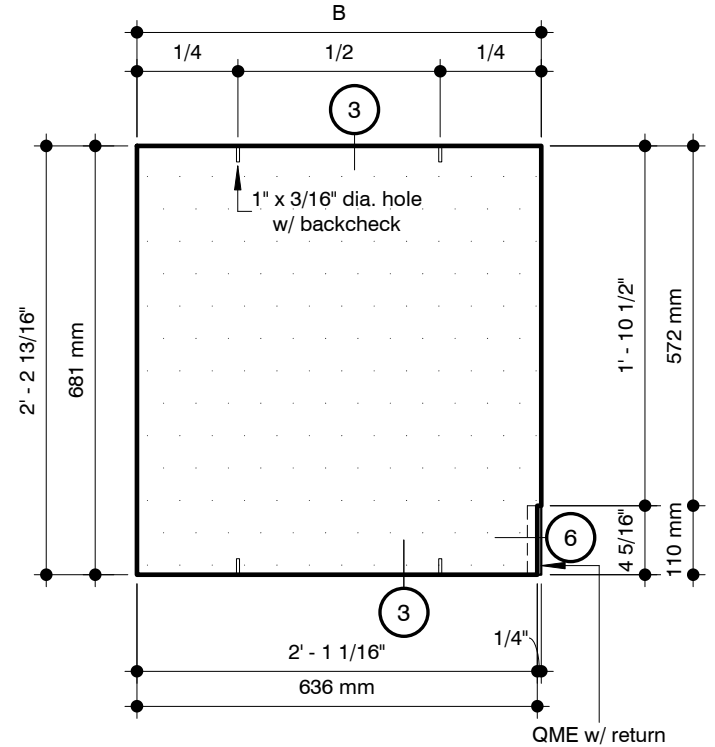

Stone Project Example

6250 Westpark Suite 218 Houston Texas 77057

Date: 02/18/09

Material: Porto Granite

Finish: Polished

Thickness: 2cm

Ticket Number: **TD13**

Mark	Stone Type	B		Quantity	Area	
		Imperial	Metric		Imperial	Metric
D6	ST-4	2' - 4 7/16"	722 mm	1	5.288 SF	0.491 m ²
D37	ST-4	2' - 1 5/16"	642 mm	1	4.701 SF	0.437 m ²
Grand total				2	9.989 SF	0.928 m ²

Abbreviations
 FE - Finished Edge QME - Quirk Mitre Edge

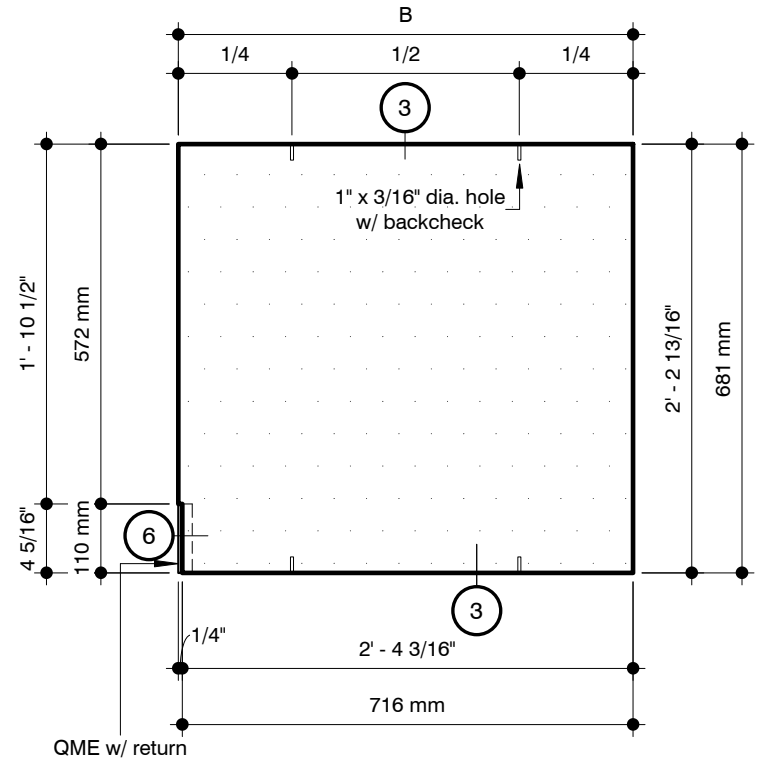

Stone Project Example

6250 Westpark Suite 218 Houston Texas 77057

Date: 02/18/09

Material: Porto Granite

Finish: Polished

Thickness: 2cm

Ticket Number: **TD14**

Mark	Stone Type	A		B		Quantity	Area	
		Imperial	Metric	Imperial	Metric		Imperial	Metric
D208	ST-4	2' - 2 1/16"	662 mm	3 5/8"	92 mm	8	5.249 SF	0.488 m ²
D209	ST-4	2' - 1 1/2"	648 mm	3 5/8"	92 mm	4	2.568 SF	0.239 m ²
D210	ST-4	2' - 1 3/8"	645 mm	3 5/8"	92 mm	4	2.555 SF	0.237 m ²
D348	ST-4	2' - 1 3/8"	645 mm	2 5/8"	67 mm	4	1.850 SF	0.172 m ²
D349	ST-4	2' - 2 1/16"	662 mm	2 5/8"	67 mm	8	3.801 SF	0.353 m ²
D350	ST-4	2' - 1 1/2"	648 mm	2 5/8"	67 mm	4	1.859 SF	0.173 m ²
Grand total						32	17.882 SF	1.661 m ²

Abbreviations
 FE - Finished Edge QME - Quirk Mitre Edge

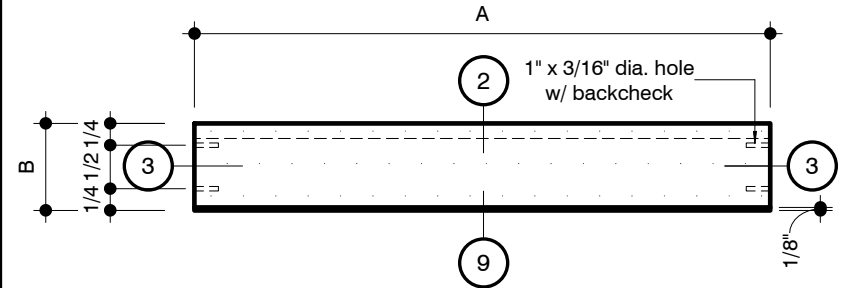

Stone Project Example

6250 Westpark Suite 218 Houston Texas 77057

Date: 02/23/09

Material: Porto Granite

Finish: Polished

Thickness: 2cm

Ticket Number: **TD15**

Mark	Stone Type	A		B		Quantity	Area	
		Imperial	Metric	Imperial	Metric		Imperial	Metric
D212	ST-4	1' - 11 7/8"	606 mm	3 5/8"	92 mm	12	7.212 SF	0.670 m ²
D213	ST-4	1' - 11 3/4"	603 mm	3 5/8"	92 mm	2	1.196 SF	0.111 m ²
Grand total						14	8.408 SF	0.781 m ²

Abbreviations
 FE - Finished Edge QME - Quirk Mitre Edge

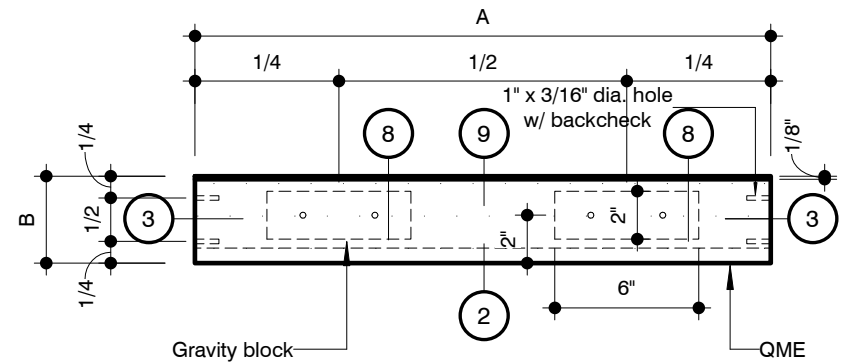

Stone Project Example

6250 Westpark Suite 218 Houston Texas 77057

Date: 02/23/09

Material: Porto Granite

Finish: Polished

Thickness: 2cm

Ticket Number: **TD16**

Mark	Stone Type	A		B		Quantity	Area	
		Imperial	Metric	Imperial	Metric		Imperial	Metric
D205	ST-4	1' - 11 7/8"	606 mm	6 3/4"	171 mm	6	6.715 SF	0.624 m ²
D206	ST-4	2' - 0 3/4"	629 mm	6 3/4"	171 mm	2	2.320 SF	0.216 m ²
D207	ST-4	1' - 11 3/4"	603 mm	6 3/4"	171 mm	1	1.113 SF	0.103 m ²
D338	ST-4	2' - 0 3/4"	629 mm	7 5/8"	194 mm	2	2.621 SF	0.244 m ²
D339	ST-4	1' - 11 7/8"	606 mm	7 5/8"	194 mm	6	7.585 SF	0.705 m ²
D340	ST-4	1' - 11 3/4"	603 mm	7 5/8"	194 mm	1	1.257 SF	0.117 m ²
D346	ST-4	2' - 0 5/8"	625 mm	7 3/4"	197 mm	2	2.651 SF	0.246 m ²
D347	ST-4	1' - 11 7/8"	606 mm	7 3/4"	197 mm	1	1.285 SF	0.119 m ²
Grand total						21	25.548 SF	2.373 m ²

Abbreviations
 FE - Finished Edge QME - Quirk Mitre Edge

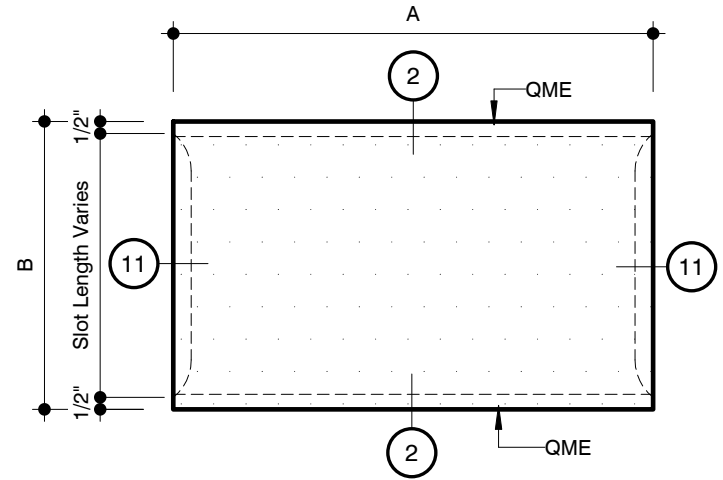

Stone Project Example

6250 Westpark Suite 218 Houston Texas 77057

Date: 02/23/09

Material: Porto Granite

Finish: Polished

Thickness: 2cm

Ticket Number: **TD17**

Mark	Stone Type	A		B		Quantity	Area	
		Imperial	Metric	Imperial	Metric		Imperial	Metric
D353	ST-4	1' - 11 7/8"	606 mm	2 5/8"	67 mm	1	0.435 SF	0.040 m ²
Grand total						1	0.435 SF	0.040 m ²

Abbreviations
 FE - Finished Edge QME - Quirk Mitre Edge

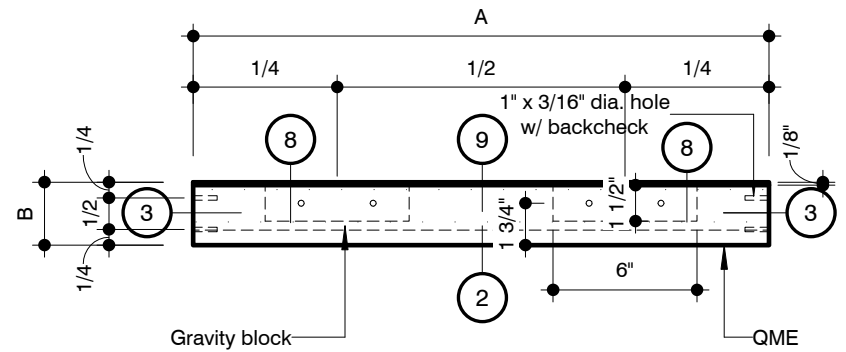

Stone Project Example

6250 Westpark Suite 218 Houston Texas 77057

Date: 02/23/09

Material: Porto Granite

Finish: Polished

Thickness: 2cm

Ticket Number: **TD18**

Mark	Stone Type	A		B		Quantity	Area	
		Imperial	Metric	Imperial	Metric		Imperial	Metric
D111	ST-4	2' - 11 7/8"	911 mm	1' - 10 3/4"	578 mm	16	90.684 SF	8.425 m ²
D112	ST-4	2' - 7 5/16"	795 mm	1' - 10 3/4"	578 mm	2	9.894 SF	0.919 m ²
D114	ST-4	3' - 6 13/16"	1087 mm	1' - 7 1/2"	495 mm	2	11.595 SF	1.077 m ²
D115	ST-4	3' - 0 13/16"	935 mm	1' - 7 1/2"	495 mm	2	9.970 SF	0.926 m ²
Grand total						22	122.143 SF	11.347 m ²

Abbreviations
 FE - Finished Edge QME - Quirk Mitre Edge

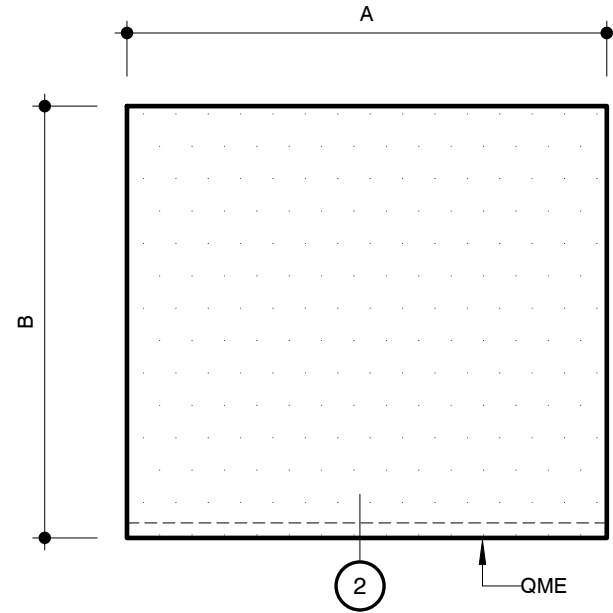

Stone Project Example

6250 Westpark Suite 218 Houston Texas 77057

Date: 02/23/09

Material: Porto Granite

Finish: Polished

Thickness: 2cm

Ticket Number: **TD19**

Mark	Stone Type	A		B		Quantity	Area	
		Imperial	Metric	Imperial	Metric		Imperial	Metric
D116	ST-4	1' - 3 3/16"	386 mm	1' - 10 3/4"	578 mm	2	4.799 SF	0.446 m ²
Grand total						2	4.799 SF	0.446 m ²

Abbreviations
 FE - Finished Edge QME - Quirk Mitre Edge

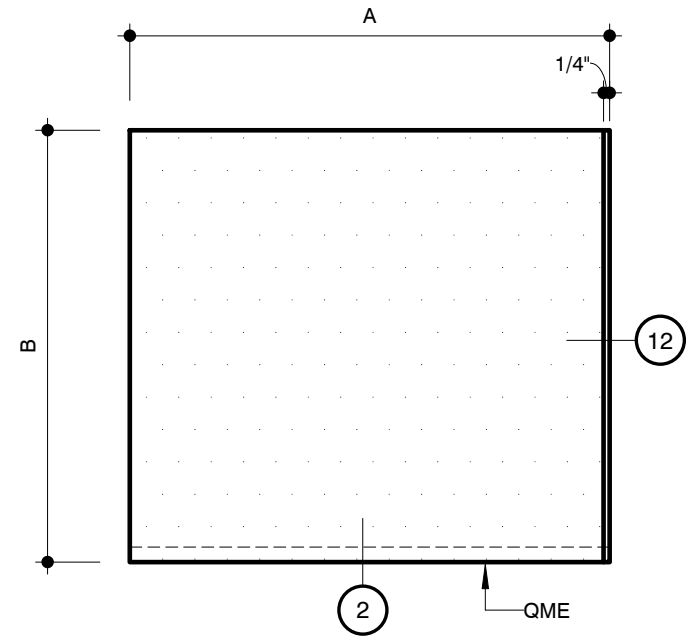

Stone Project Example

6250 Westpark Suite 218 Houston Texas 77057

Date: 02/23/09

Material: Porto Granite

Finish: Polished

Thickness: 2cm

Ticket Number: **TD20**

Mark	Stone Type	A		B		Quantity	Area	
		Imperial	Metric	Imperial	Metric		Imperial	Metric
D117	ST-4	2' - 11 7/8"	911 mm	4' - 5 3/4"	1365 mm	16	214.253 SF	19.905 m ²
D118	ST-4	2' - 8 1/4"	819 mm	4' - 5 3/4"	1365 mm	2	24.058 SF	2.235 m ²
D120	ST-4	3' - 6 13/16"	1087 mm	4' - 5 3/4"	1365 mm	2	31.961 SF	2.969 m ²
D121	ST-4	3' - 0 13/16"	935 mm	4' - 5 3/4"	1365 mm	2	27.482 SF	2.553 m ²
Grand total						22	297.754 SF	27.662 m ²

Abbreviations
 FE - Finished Edge QME - Quirk Mitre Edge

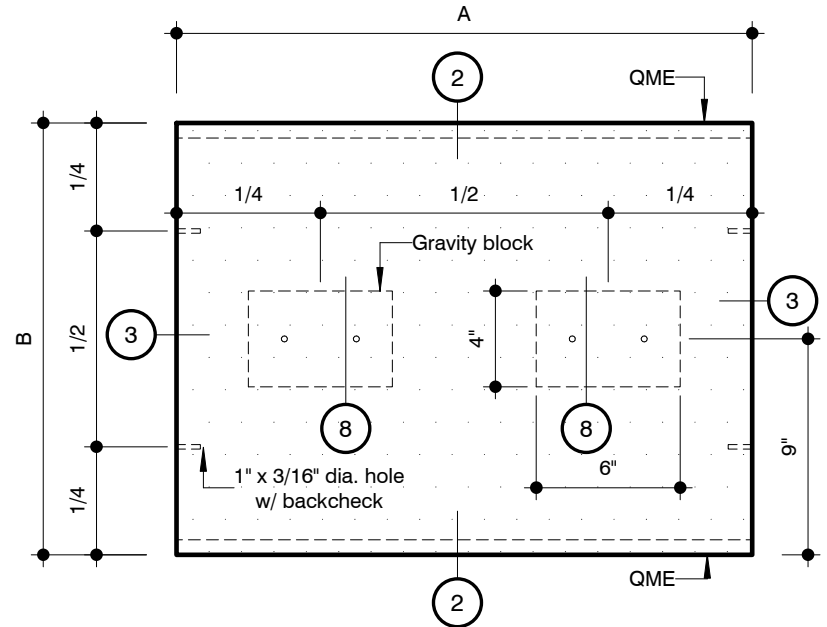

Stone Project Example

6250 Westpark Suite 218 Houston Texas 77057

Date: 02/15/09

Material: Porto Granite

Finish: Polished

Thickness: 2cm

Ticket Number: **TD21**

Mark	Stone Type	A		B		Quantity	Area	
		Imperial	Metric	Imperial	Metric		Imperial	Metric
D119	ST-4	1' - 3 3/16"	386 mm	4' - 5 3/4"	1365 mm	2	11.338 SF	1.053 m ²
Grand total						2	11.338 SF	1.053 m ²

Abbreviations
 FE - Finished Edge QME - Quirk Mitre Edge

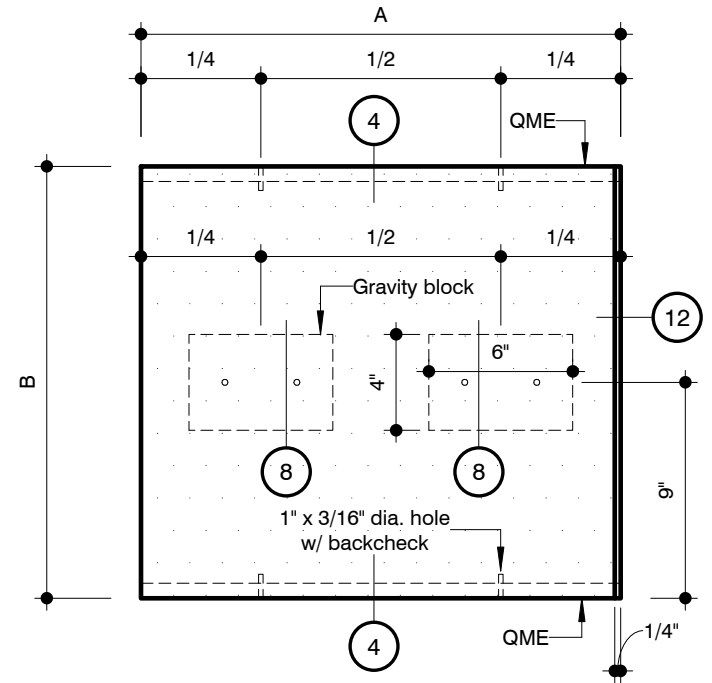

Stone Project Example

6250 Westpark Suite 218 Houston Texas 77057

Date: 02/23/09

Material: Porto Granite

Finish: Polished

Thickness: 2cm

Ticket Number: **TD22**

Mark	Stone Type	A		B		Quantity	Area	
		Imperial	Metric	Imperial	Metric		Imperial	Metric
D110	ST-4	9 3/4"	248 mm	3' - 5 15/16"	1066 mm	1	2.841 SF	0.264 m ²
D354	ST-4	3' - 0 13/16"	935 mm	1' - 7 1/2"	495 mm	2	9.970 SF	0.926 m ²
D355	ST-4	3' - 6 13/16"	1087 mm	1' - 7 1/2"	495 mm	2	11.595 SF	1.077 m ²
D357	ST-4	2' - 7 5/16"	795 mm	1' - 10 3/4"	578 mm	2	9.894 SF	0.919 m ²
D358	ST-4	2' - 11 7/8"	911 mm	1' - 10 3/4"	578 mm	16	90.684 SF	8.425 m ²
Grand total						23	124.984 SF	11.611 m ²

Abbreviations
 FE - Finished Edge QME - Quirk Mitre Edge

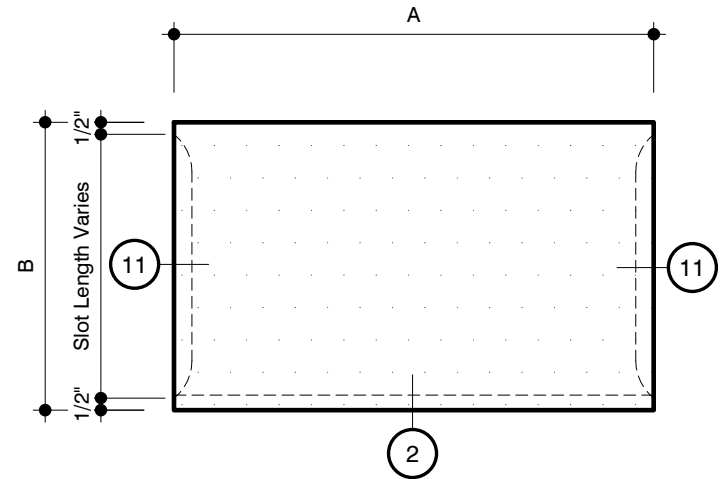

Stone Project Example

6250 Westpark Suite 218 Houston Texas 77057

Date: 02/23/09

Material: Porto Granite

Finish: Polished

Thickness: 2cm

Ticket Number: **TD23**

Mark	Stone Type	A		B		Quantity	Area	
		Imperial	Metric	Imperial	Metric		Imperial	Metric
D293	ST-4	1' - 9 11/16"	551 mm	9 3/4"	248 mm	12	17.621 SF	1.637 m ²
D356	ST-4	1' - 7 3/4"	502 mm	1' - 11"	584 mm	2	6.309 SF	0.586 m ²
Grand total						14	23.930 SF	2.223 m ²

Abbreviations
FE - Finished Edge QME - Quirk Mitre Edge

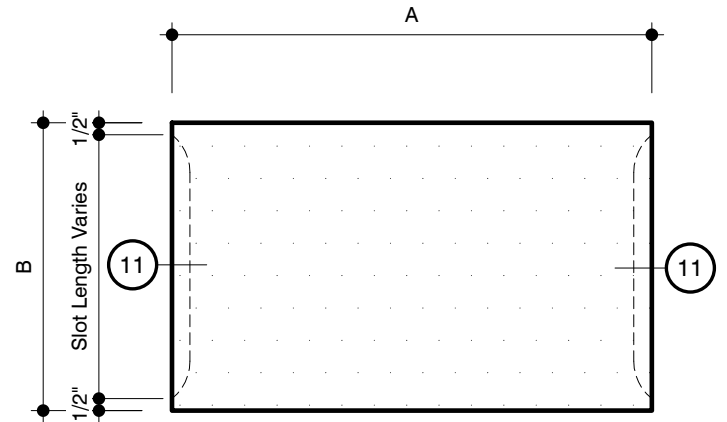

Stone Project Example

6250 Westpark Suite 218 Houston Texas 77057

Date: 02/23/09

Material: Porto Granite

Finish: Polished

Thickness: 2cm

Ticket Number: **TD24**

Mark	Stone Type	A		B		Quantity	Area	
		Imperial	Metric	Imperial	Metric		Imperial	Metric
D136	ST-4	6 3/4"	171 mm	2' - 1 3/8"	645 mm	2	2.379 SF	0.221 m ²
D137	ST-4	6 3/4"	171 mm	2' - 2 1/16"	662 mm	4	4.887 SF	0.454 m ²
D138	ST-4	6 3/4"	171 mm	2' - 1 1/2"	648 mm	2	2.391 SF	0.222 m ²
D214	ST-4	1' - 4 1/2"	419 mm	2' - 1 3/8"	645 mm	1	2.908 SF	0.270 m ²
D215	ST-4	1' - 4 1/2"	419 mm	2' - 1 7/16"	646 mm	2	5.829 SF	0.542 m ²
D216	ST-4	1' - 4 1/2"	419 mm	2' - 1 1/2"	648 mm	1	2.922 SF	0.271 m ²
D335	ST-4	7 5/8"	194 mm	2' - 1 3/8"	645 mm	2	2.687 SF	0.250 m ²
D336	ST-4	7 5/8"	194 mm	2' - 2 1/16"	662 mm	4	5.520 SF	0.513 m ²
D337	ST-4	7 5/8"	194 mm	2' - 1 1/2"	648 mm	2	2.701 SF	0.251 m ²
D343	ST-4	7 3/4"	197 mm	2' - 1 3/8"	645 mm	4	5.463 SF	0.507 m ²
D344	ST-4	7 3/4"	197 mm	2' - 2 1/16"	662 mm	8	11.221 SF	1.042 m ²
D345	ST-4	7 3/4"	197 mm	2' - 1 1/2"	648 mm	4	5.490 SF	0.510 m ²
Grand total						36	54.397 SF	5.054 m ²

Abbreviations
 FE - Finished Edge QME - Quirk Mitre Edge

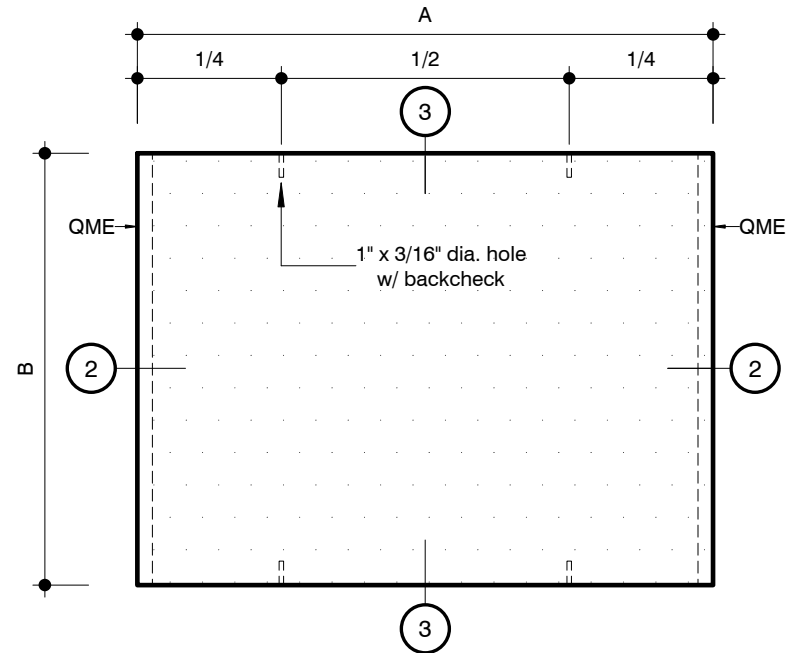

Stone Project Example

6250 Westpark Suite 218 Houston Texas 77057

Date: 02/15/09

Material: Porto Granite

Finish: Polished

Thickness: 2cm

Ticket Number: **TD25**

Mark	Stone Type	A		B		Quantity	Area	
		Imperial	Metric	Imperial	Metric		Imperial	Metric
D228	ST-4	8 1/4"	210 mm	2' - 1 3/8"	645 mm	1	1.454 SF	0.135 m ²
D229	ST-4	8 1/4"	210 mm	2' - 1 7/16"	646 mm	2	2.915 SF	0.271 m ²
D230	ST-4	8 1/4"	210 mm	2' - 1 1/2"	648 mm	1	1.461 SF	0.136 m ²
D235	ST-4	6 1/8"	155 mm	2' - 1 3/8"	645 mm	1	1.075 SF	0.100 m ²
D236	ST-4	6 1/8"	155 mm	2' - 1 7/16"	646 mm	2	2.156 SF	0.200 m ²
D237	ST-4	6 1/8"	155 mm	2' - 1 1/2"	648 mm	1	1.080 SF	0.100 m ²
D248	ST-4	9 15/16"	252 mm	2' - 1 3/8"	645 mm	2	3.502 SF	0.325 m ²
D250	ST-4	9 15/16"	252 mm	2' - 1 7/16"	646 mm	2	3.511 SF	0.326 m ²
D252	ST-4	9 15/16"	252 mm	2' - 1 1/2"	648 mm	2	3.520 SF	0.327 m ²
D253	ST-4	1' - 3 15/16"	405 mm	2' - 1 3/8"	645 mm	1	2.808 SF	0.261 m ²
D254	ST-4	1' - 3 15/16"	405 mm	2' - 1 7/16"	646 mm	1	2.815 SF	0.262 m ²
D255	ST-4	1' - 3 15/16"	405 mm	2' - 1 1/2"	648 mm	1	2.822 SF	0.262 m ²
D256	ST-4	1' - 3 7/8"	403 mm	2' - 1 3/8"	645 mm	1	2.797 SF	0.260 m ²
D257	ST-4	1' - 3 7/8"	403 mm	2' - 1 7/16"	646 mm	1	2.804 SF	0.261 m ²
D258	ST-4	1' - 3 7/8"	403 mm	2' - 1 1/2"	648 mm	1	2.811 SF	0.261 m ²
D383	ST-4	9 15/16"	252 mm	2' - 3 3/16"	691 mm	2	3.752 SF	0.349 m ²
D385	ST-4	1' - 3 7/8"	403 mm	2' - 3 3/16"	691 mm	1	2.997 SF	0.278 m ²
D386	ST-4	1' - 3 15/16"	405 mm	2' - 3 3/16"	691 mm	1	3.009 SF	0.280 m ²
Grand total						24	47.291 SF	4.393 m ²

Abbreviations
FE - Finished Edge QME - Quirk Mitre Edge

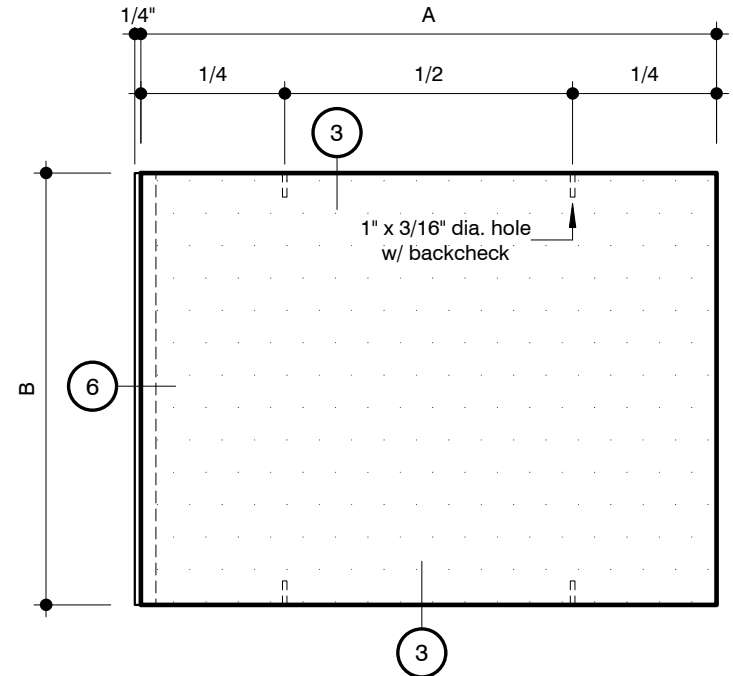

Stone Project Example

6250 Westpark Suite 218 Houston Texas 77057

Date: 02/15/09

Material: Porto Granite

Finish: Polished

Thickness: 2cm

Ticket Number: **TD26**

Mark	Stone Type	A		B		Quantity	Area	
		Imperial	Metric	Imperial	Metric		Imperial	Metric
D107	ST-4	9 3/4"	248 mm	2' - 1 3/8"	645 mm	2	3.436 SF	0.319 m ²
D108	ST-4	9 3/4"	248 mm	2' - 1 9/16"	650 mm	1	1.732 SF	0.161 m ²
D109	ST-4	9 3/4"	248 mm	1' - 11 3/8"	594 mm	1	1.583 SF	0.147 m ²
D157	ST-4	1' - 6 3/16"	462 mm	2' - 1 7/16"	646 mm	2	6.426 SF	0.597 m ²
D158	ST-4	1' - 6 3/16"	462 mm	2' - 1 1/2"	648 mm	1	3.221 SF	0.299 m ²
D159	ST-4	1' - 6 3/16"	462 mm	3' - 1"	940 mm	1	4.673 SF	0.434 m ²
D217	ST-4	1' - 4 3/4"	425 mm	3' - 1"	940 mm	1	4.304 SF	0.400 m ²
Grand total						9	25.375 SF	2.357 m ²

Abbreviations
 FE - Finished Edge QME - Quirk Mitre Edge

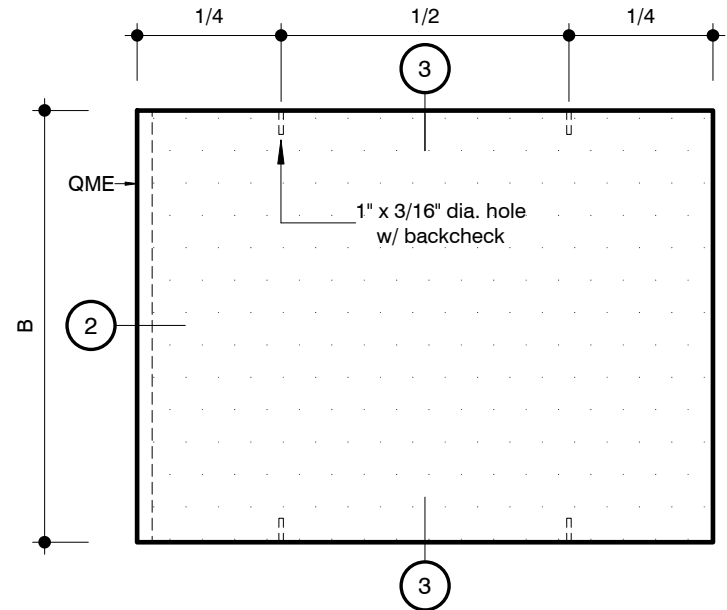

Stone Project Example

6250 Westpark Suite 218 Houston Texas 77057

Date: 02/15/09

Material: Porto Granite

Finish: Polished

Thickness: 2cm

Ticket Number: **TD27**

Mark	Stone Type	A		B		Quantity	Area	
		Imperial	Metric	Imperial	Metric		Imperial	Metric
D113	ST-4	1' - 7 3/4"	502 mm	1' - 11"	584 mm	2	6.309 SF	0.586 m ²
Grand total						2	6.309 SF	0.586 m ²

Abbreviations
 FE - Finished Edge QME - Quirk Mitre Edge

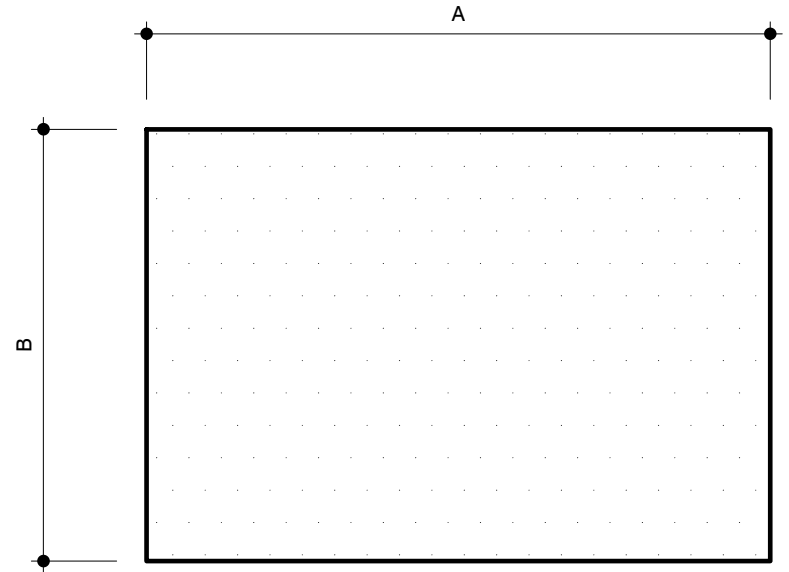

Stone Project Example

6250 Westpark Suite 218 Houston Texas 77057

Date: 02/26/09	Material: Porto Granite	Finish: Polished	Thickness: 2cm	Ticket Number: TD28
----------------	-------------------------	------------------	----------------	----------------------------

Mark	Stone Type	A		B		Quantity	Area	
		Imperial	Metric	Imperial	Metric		Imperial	Metric
D134	ST-4	1' - 11 13/16"	605 mm	3' - 0 3/4"	933 mm	2	12.154 SF	1.129 m ²
D135	ST-4	1' - 11 7/8"	606 mm	3' - 0 3/4"	933 mm	1	6.093 SF	0.566 m ²
D151	ST-4	1' - 8 13/16"	529 mm	3' - 0 3/4"	933 mm	6	31.869 SF	2.961 m ²
D202	ST-4	1' - 11 7/8"	606 mm	3' - 0 3/4"	933 mm	14	85.303 SF	7.925 m ²
D203	ST-4	1' - 11 3/4"	603 mm	3' - 0 3/4"	933 mm	2	12.120 SF	1.126 m ²
D218	ST-4	1' - 11 7/8"	606 mm	2' - 11 3/4"	908 mm	2	11.855 SF	1.101 m ²
Grand total						27	159.395 SF	14.808 m ²

Abbreviations
 FE - Finished Edge QME - Quirk Mitre Edge

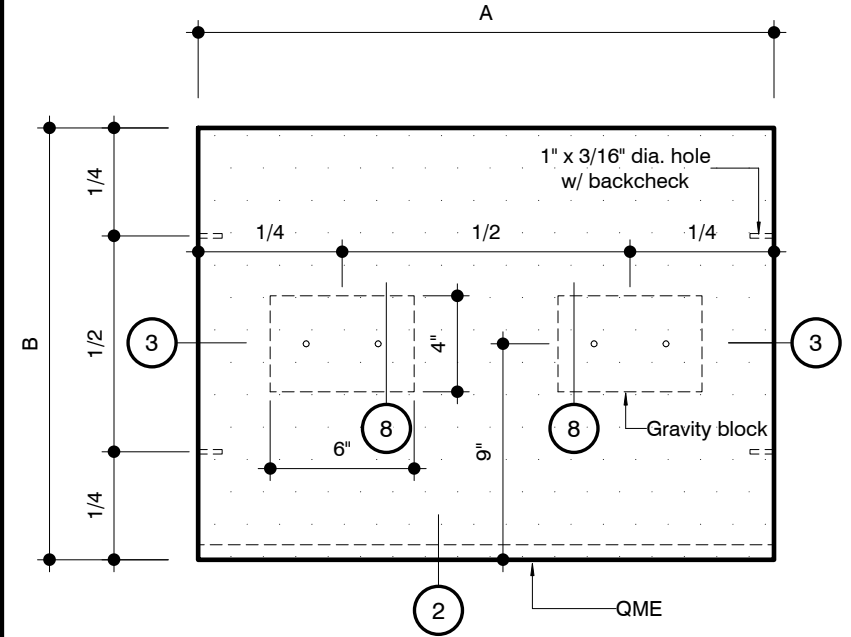

Stone Project Example

6250 Westpark Suite 218 Houston Texas 77057

Date: 02/26/09

Material: Porto Granite

Finish: Polished

Thickness: 2cm

Ticket Number: **TD29**

Mark	Stone Type	A		B		Quantity	Area	
		Imperial	Metric	Imperial	Metric		Imperial	Metric
D342	ST-4	2' - 0"	610 mm	7 3/4"	197 mm	2	2.583 SF	0.240 m ²
Grand total						2	2.583 SF	0.240 m ²

Abbreviations
 FE - Finished Edge QME - Quirk Mitre Edge

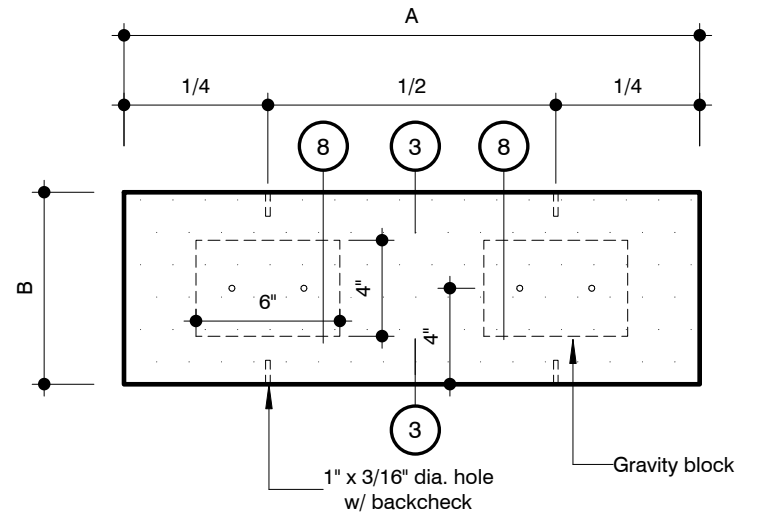

Stone Project Example

6250 Westpark Suite 218 Houston Texas 77057

Date: 02/26/09

Material: Porto Granite

Finish: Polished

Thickness: 2cm

Ticket Number: **TD30**

Mark	Stone Type	Quantity	Area	
			Imperial	Metric
D8	ST-4	1	4.133 SF	0.384 m ²

Abbreviations
 FE - Finished Edge QME - Quirk Mitre Edge

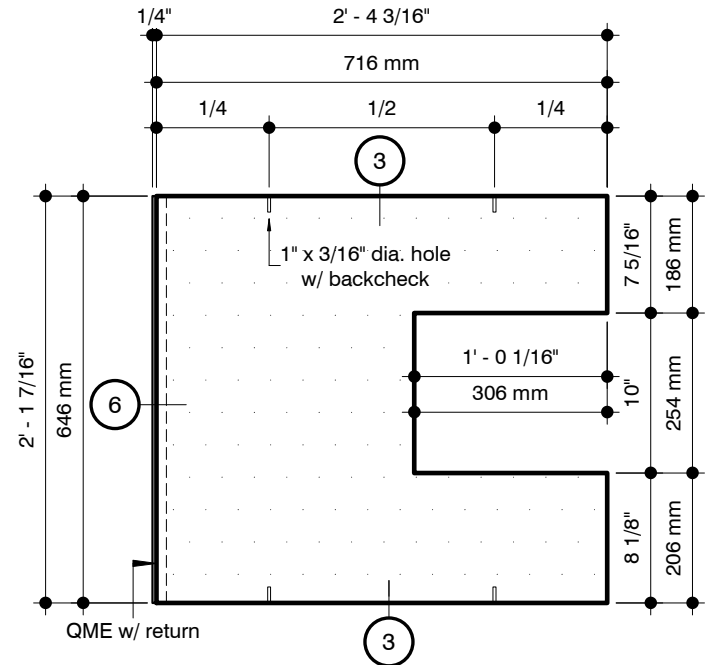

Stone Project Example

6250 Westpark Suite 218 Houston Texas 77057

Date: 02/18/09

Material: Porto Granite

Finish: Polished

Thickness: 2cm

Ticket Number: **TD31**

Mark	Stone Type	Quantity	Area	
			Imperial	Metric
D12	ST-4	1	4.133 SF	0.384 m ²

Abbreviations
 FE - Finished Edge QME - Quirk Mitre Edge

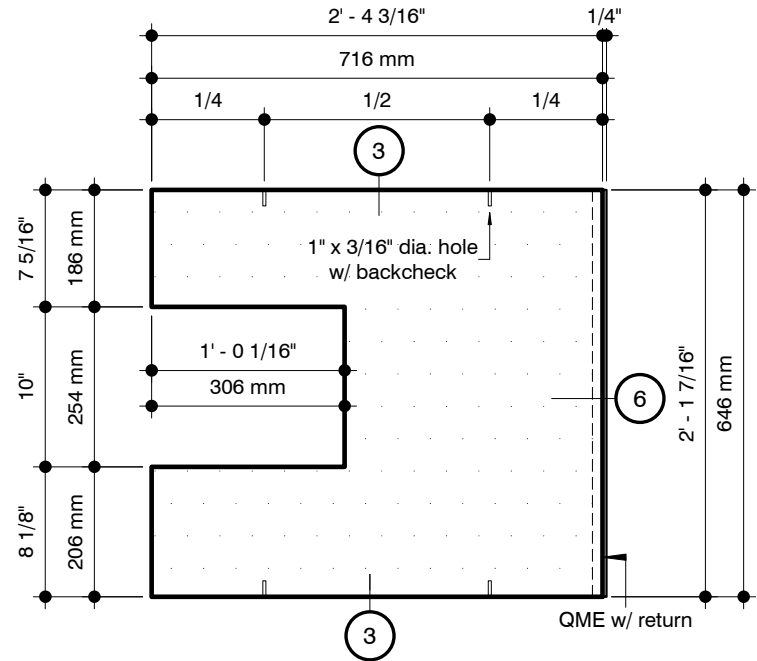

Stone Project Example

6250 Westpark Suite 218 Houston Texas 77057

Date: 02/18/09	Material: Porto Granite	Finish: Polished	Thickness: 2cm	Ticket Number: TD32
----------------	-------------------------	------------------	----------------	----------------------------

Mark	Stone Type	Quantity	Area	
			Imperial	Metric
D36	ST-4	1	3.987 SF	0.370 m ²

Abbreviations
 FE - Finished Edge QME - Quirk Mitre Edge

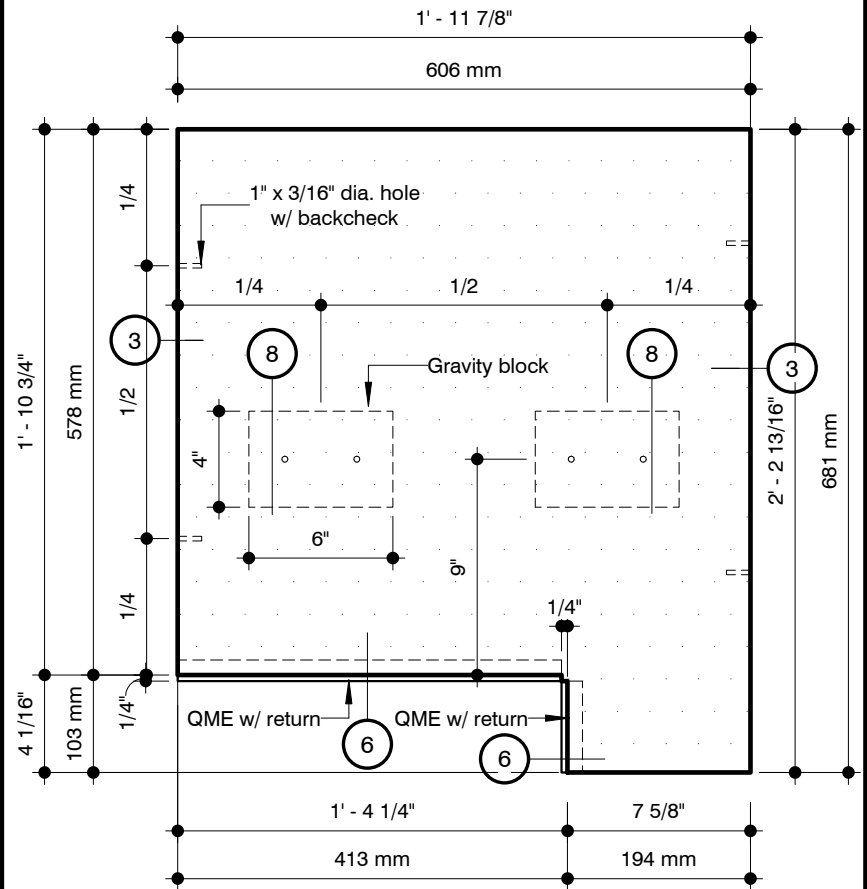

Stone Project Example

6250 Westpark Suite 218 Houston Texas 77057

Date: 02/18/09	Material: Porto Granite	Finish: Polished	Thickness: 2cm	Ticket Number: TD33
----------------	-------------------------	------------------	----------------	----------------------------

Mark	Stone Type	Quantity	Area	
			Imperial	Metric
D78	ST-4	1	4.578 SF	0.425 m ²

Abbreviations
 FE - Finished Edge QME - Quirk Mitre Edge

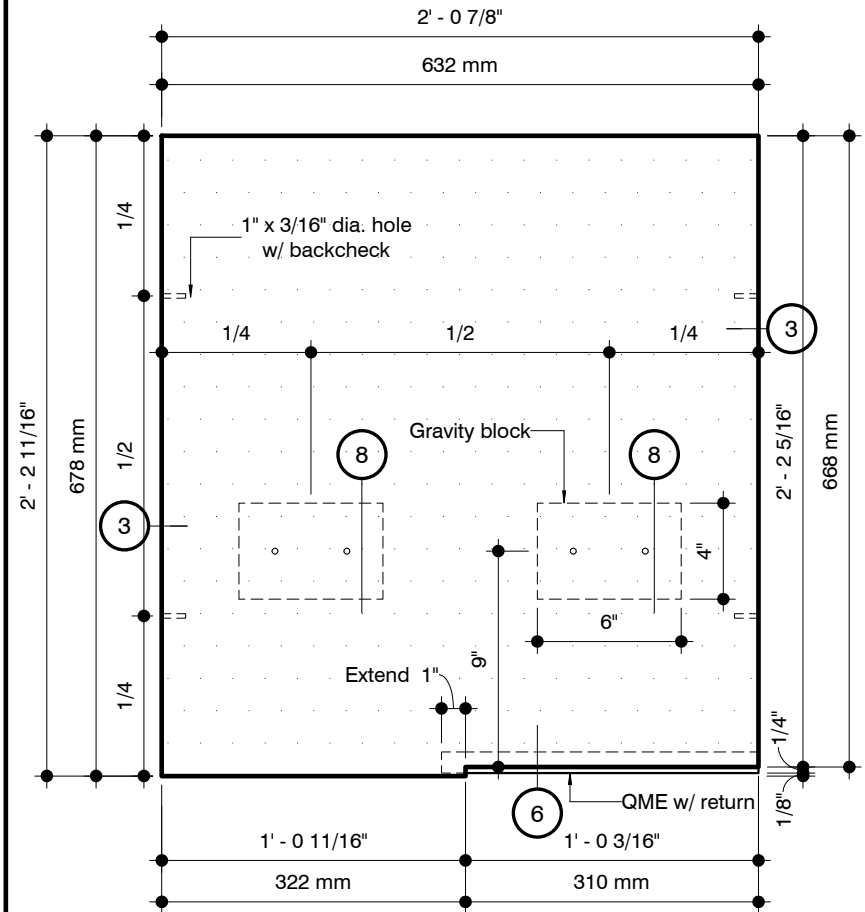

Stone Project Example

6250 Westpark Suite 218 Houston Texas 77057

Date: 02/19/09

Material: Porto Granite

Finish: Polished

Thickness: 2cm

Ticket Number: **TD34**

Mark	Stone Type	Quantity	Area	
			Imperial	Metric
D76	ST-4	1	4.048 SF	0.376 m ²

Abbreviations
 FE - Finished Edge QME - Quirk Mitre Edge

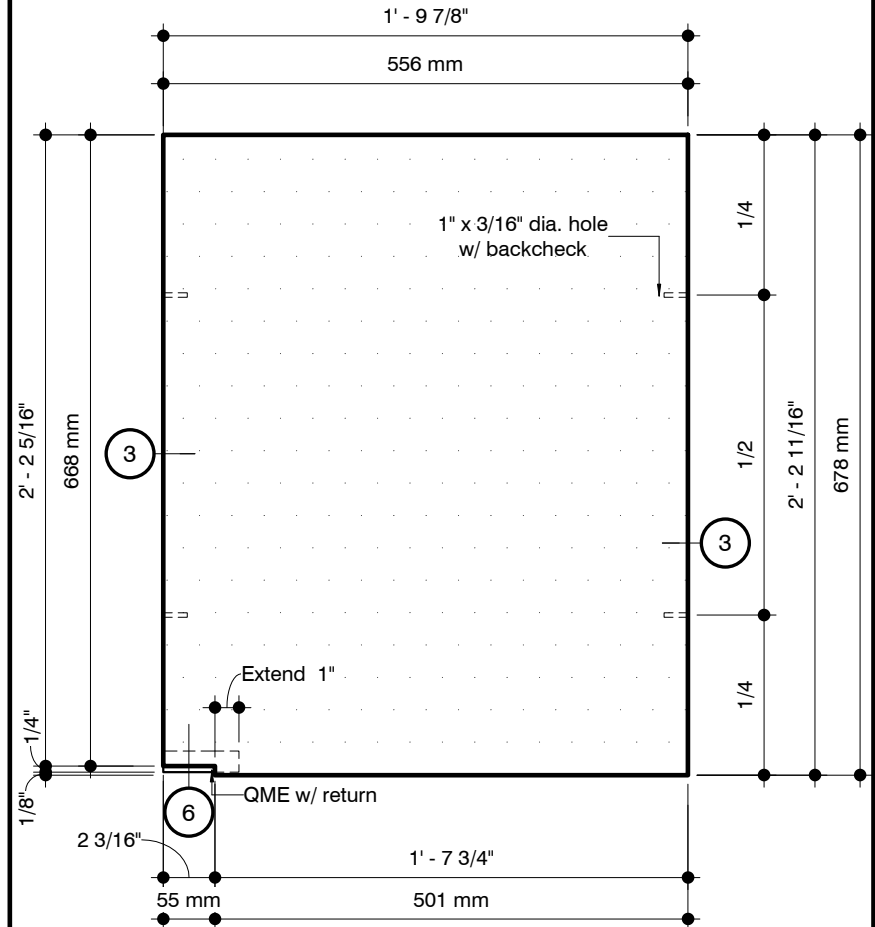

Stone Project Example

6250 Westpark Suite 218 Houston Texas 77057

Date: 02/19/09

Material: Porto Granite

Finish: Polished

Thickness: 2cm

Ticket Number: **TD35**

Mark	Stone Type	Quantity	Area	
			Imperial	Metric
D329	ST-4	2	1.417 SF	0.132 m ²

Abbreviations
 FE - Finished Edge QME - Quirk Mitre Edge

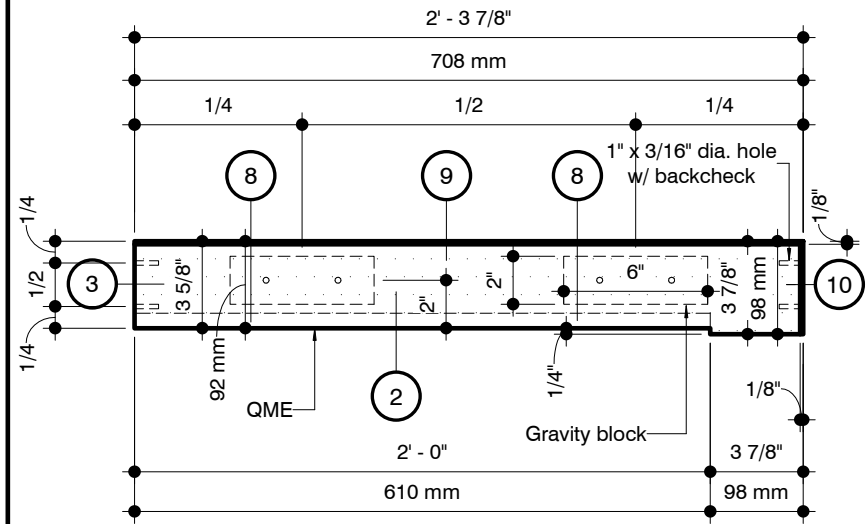

Stone Project Example

6250 Westpark Suite 218 Houston Texas 77057

Date: 02/23/09	Material: Porto Granite	Finish: Polished	Thickness: 2cm	Ticket Number: TD36
----------------	-------------------------	------------------	----------------	----------------------------

Mark	Stone Type	Quantity	Area	
			Imperial	Metric
D93	ST-4	1	15.294 SF	1.421 m ²

Abbreviations
 FE - Finished Edge QME - Quirk Mitre Edge

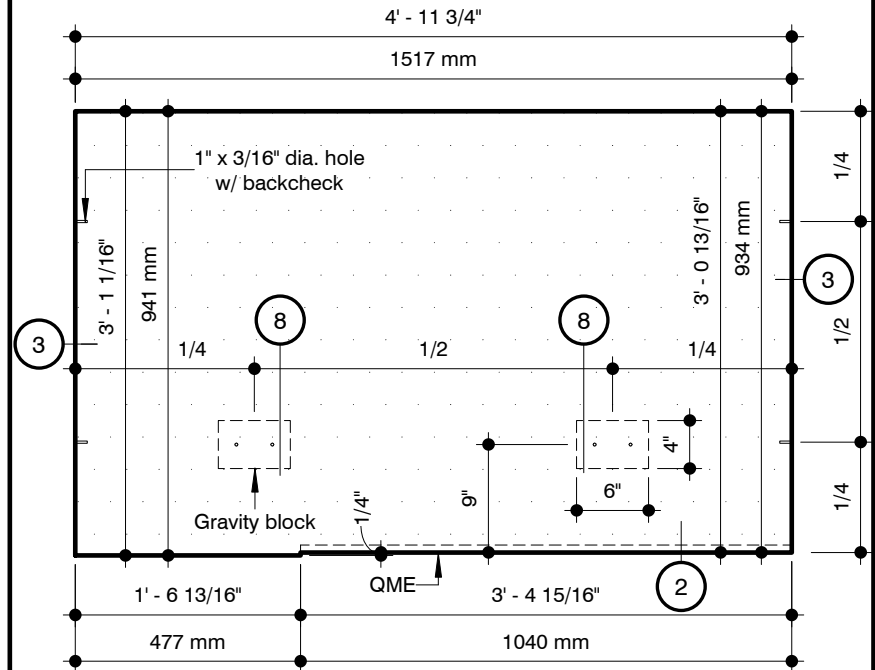

Stone Project Example

6250 Westpark Suite 218 Houston Texas 77057

Date: 02/25/09

Material: Porto Granite

Finish: Polished

Thickness: 2cm

Ticket Number: **TD37**

Mark	Stone Type	Quantity	Area	
			Imperial	Metric
D211	ST-4	2	1.417 SF	0.132 m ²

Abbreviations
 FE - Finished Edge QME - Quirk Mitre Edge

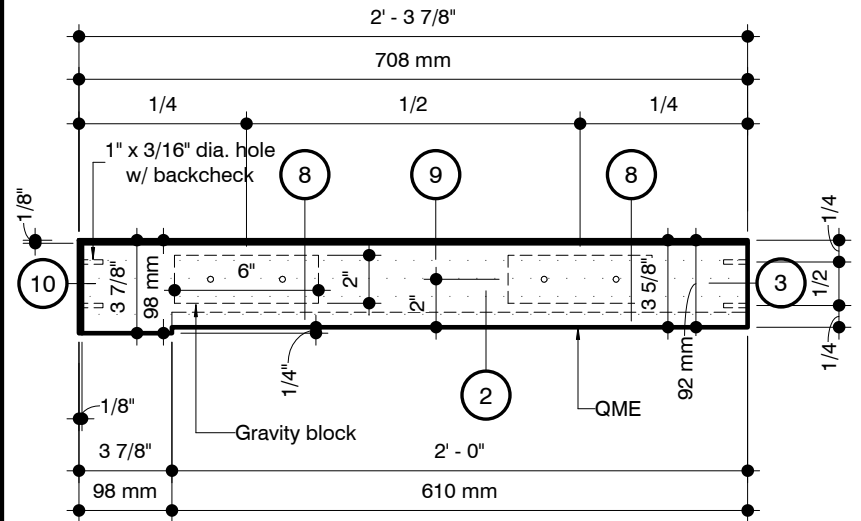

Stone Project Example

6250 Westpark Suite 218 Houston Texas 77057

Date: 02/23/09	Material: Porto Granite	Finish: Polished	Thickness: 2cm	Ticket Number: TD38
----------------	-------------------------	------------------	----------------	----------------------------

Mark	Stone Type	Quantity	Area	
			Imperial	Metric
D351	ST-4	1	0.494 SF	0.046 m ²

Abbreviations
 FE - Finished Edge QME - Quirk Mitre Edge

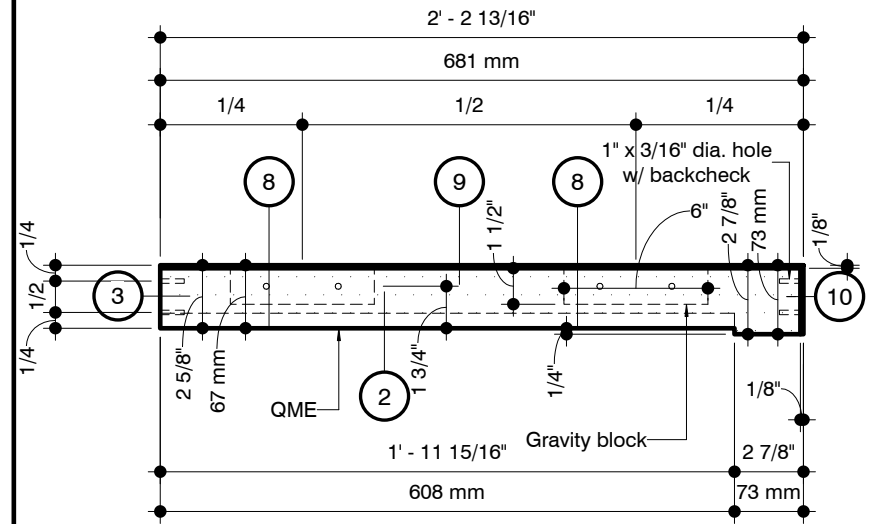

Stone Project Example

6250 Westpark Suite 218 Houston Texas 77057

Date: 02/23/09

Material: Porto Granite

Finish: Polished

Thickness: 2cm

Ticket Number: **TD39**

Mark	Stone Type	Quantity	Area	
			Imperial	Metric
D352	ST-4	1	0.494 SF	0.046 m ²

Abbreviations
 FE - Finished Edge QME - Quirk Mitre Edge

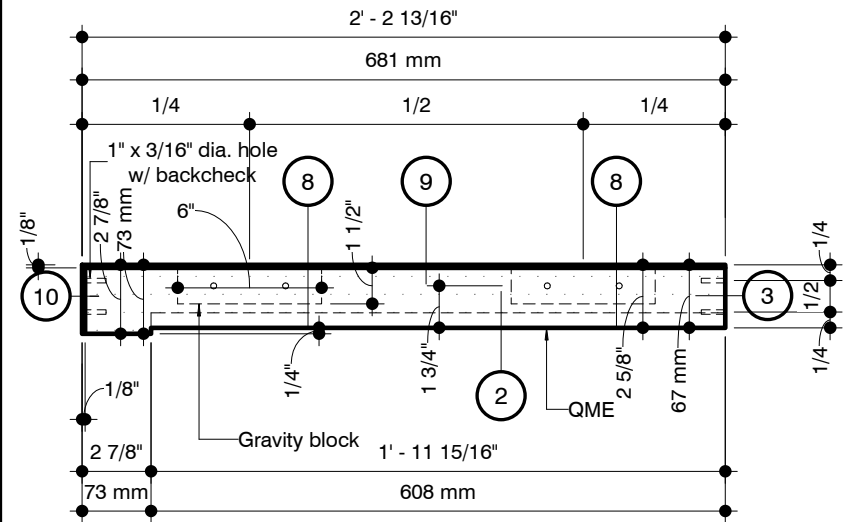

Stone Project Example

6250 Westpark Suite 218 Houston Texas 77057

Date: 02/23/09	Material: Porto Granite	Finish: Polished	Thickness: 2cm	Ticket Number: TD40
----------------	-------------------------	------------------	----------------	----------------------------

Mark	Stone Type	Quantity	Area	
			Imperial	Metric
D372	ST-4	3	9.870 SF	0.917 m ²

Abbreviations
 FE - Finished Edge QME - Quirk Mitre Edge

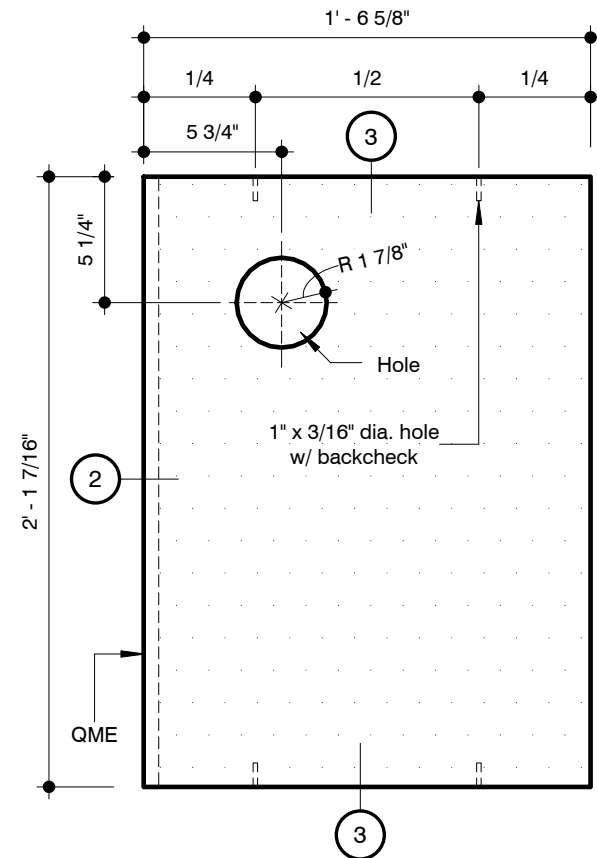

Stone Project Example

6250 Westpark Suite 218 Houston Texas 77057

Date: 02/25/09

Material: Porto Granite

Finish: Polished

Thickness: 2cm

Ticket Number: **TD41**

Mark	Stone Type	Quantity	Area	
			Imperial	Metric
D269	ST-4	3	10.549 SF	0.980 m ²

Abbreviations
 FE - Finished Edge QME - Quirk Mitre Edge

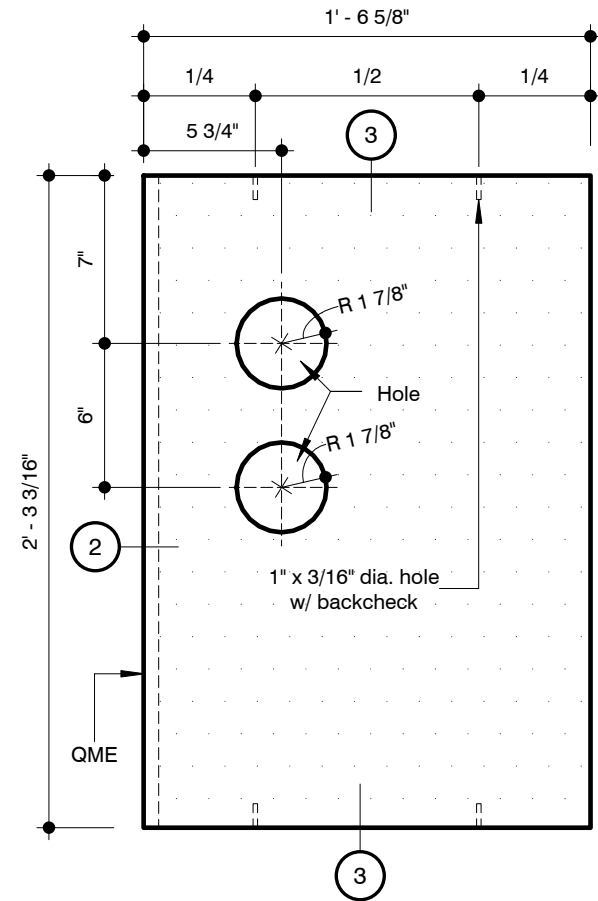

Stone Project Example

6250 Westpark Suite 218 Houston Texas 77057

Date: 02/25/09

Material: Porto Granite

Finish: Polished

Thickness: 2cm

Ticket Number: **TD42**

Mark	Stone Type	Quantity	Area	
			Imperial	Metric
D330	ST-4	1	6.081 SF	0.565 m ²

Abbreviations
 FE - Finished Edge QME - Quirk Mitre Edge

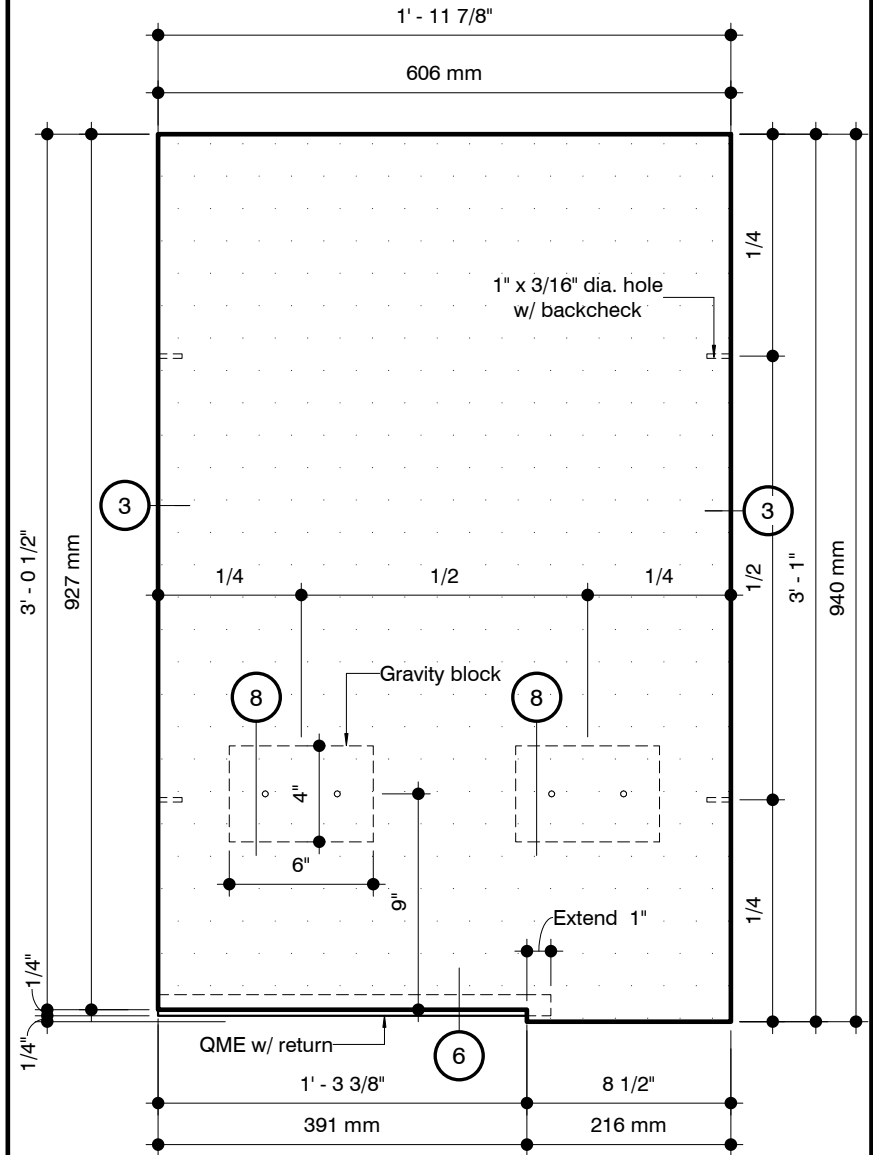

Stone Project Example

6250 Westpark Suite 218 Houston Texas 77057

Date: 02/26/09

Material: Porto Granite

Finish: Polished

Thickness: 2cm

Ticket Number: **TD43**

Mark	Stone Type	Quantity	Area	
			Imperial	Metric
D331	ST-4	1	6.081 SF	0.565 m ²

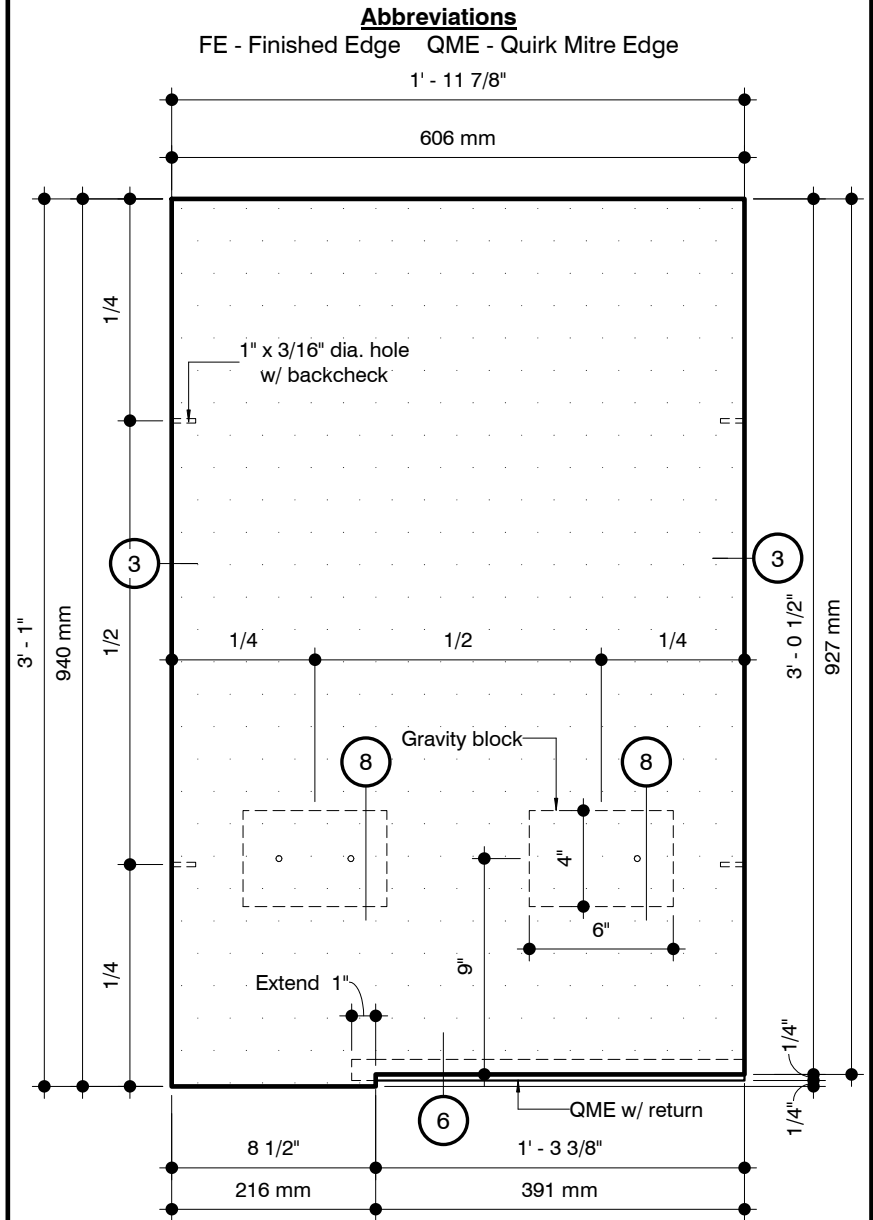

Stone Project Example

6250 Westpark Suite 218 Houston Texas 77057

Date: 02/26/09

Material: Porto Granite

Finish: Polished

Thickness: 2cm

Ticket Number: **TD44**

Mark	Stone Type	Quantity	Area	
			Imperial	Metric
D238	ST-4	1	5.529 SF	0.514 m ²

Abbreviations
 FE - Finished Edge QME - Quirk Mitre Edge

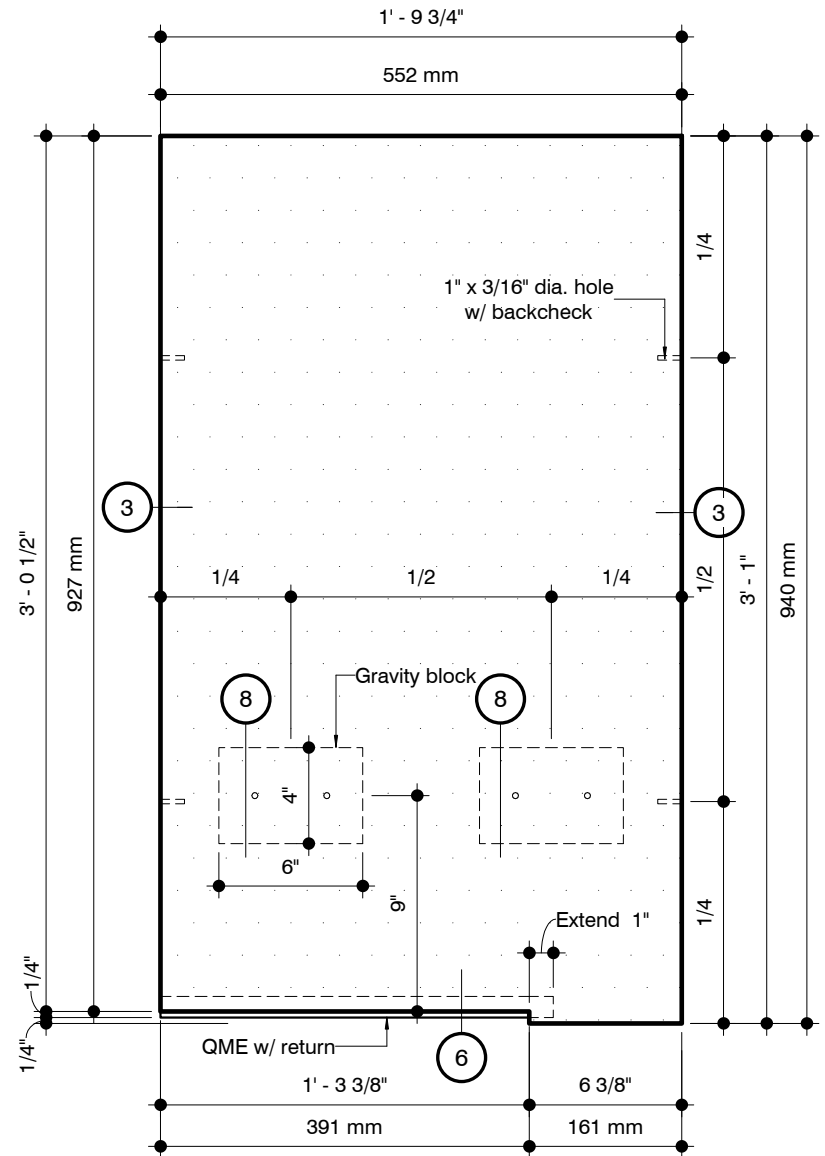

Stone Project Example

6250 Westpark Suite 218 Houston Texas 77057

Date: 02/26/09

Material: Porto Granite

Finish: Polished

Thickness: 2cm

Ticket Number: **TD45**

Mark	Stone Type	Quantity	Area	
			Imperial	Metric
D359	ST-4	1	2.399 SF	0.223 m ²

Abbreviations
 FE - Finished Edge QME - Quirk Mitre Edge

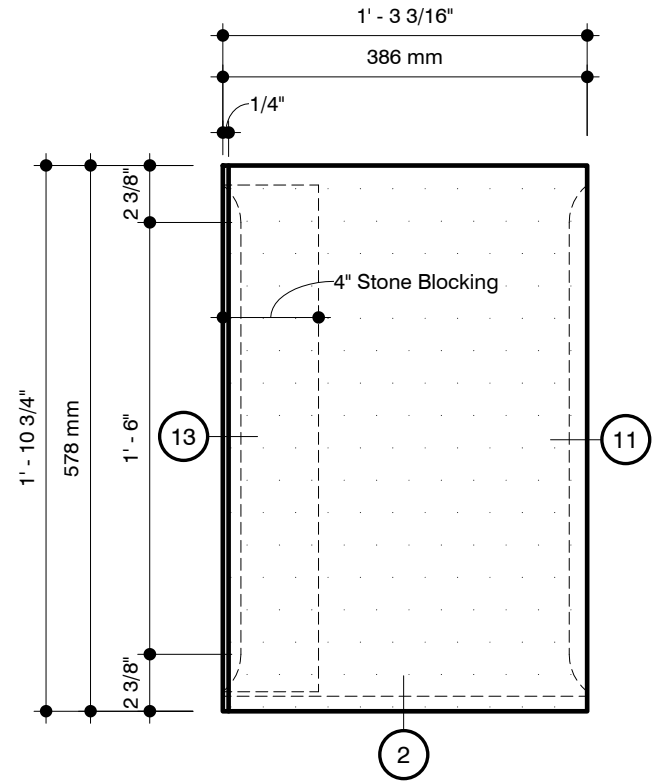

Stone Project Example

6250 Westpark Suite 218 Houston Texas 77057

Date: 02/27/09	Material: Porto Granite	Finish: Polished	Thickness: 2cm	Ticket Number: TD46
----------------	-------------------------	------------------	----------------	----------------------------

Mark	Stone Type	Quantity	Area	
			Imperial	Metric
D388	ST-4	1	2.399 SF	0.223 m ²

Abbreviations
 FE - Finished Edge QME - Quirk Mitre Edge

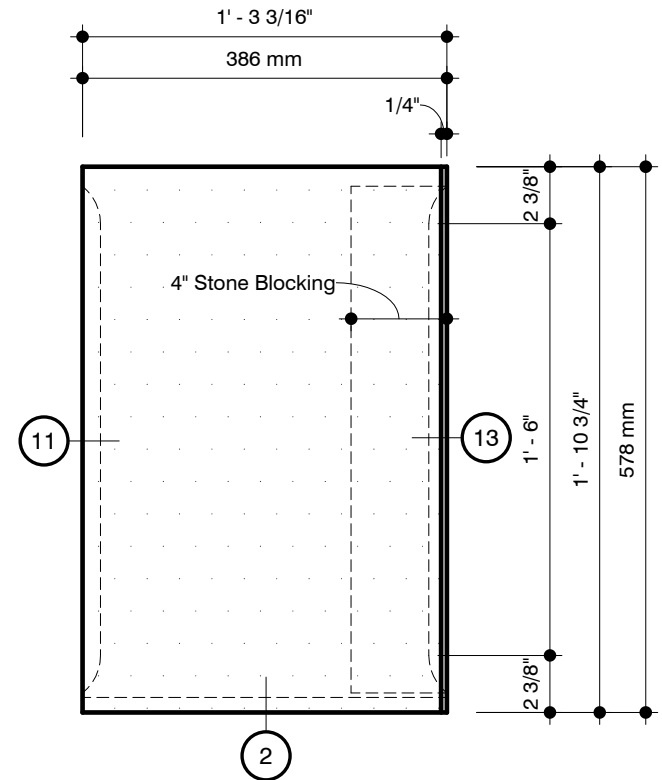

Stone Project Example

6250 Westpark Suite 218 Houston Texas 77057

Date: 02/27/09

Material: Porto Granite

Finish: Polished

Thickness: 2cm

Ticket Number: **TD47**

Mark	Stone Type	A		B		Quantity	Area	
		Imperial	Metric	Imperial	Metric		Imperial	Metric
E64	ST-5	2' - 9 1/2"	850 mm	2' - 1 3/8"	645 mm	4	23.596 SF	2.192 m ²
E65	ST-5	2' - 8 5/8"	829 mm	2' - 1 3/8"	645 mm	6	34.494 SF	3.205 m ²
E67	ST-5	2' - 8 9/16"	827 mm	2' - 1 3/8"	645 mm	2	11.476 SF	1.066 m ²
E69	ST-5	1' - 11 7/8"	606 mm	2' - 1 3/8"	645 mm	3	12.621 SF	1.173 m ²
E70	ST-5	1' - 11 7/8"	606 mm	2' - 1 7/16"	646 mm	3	12.653 SF	1.175 m ²
E73	ST-5	1' - 11 7/8"	606 mm	3' - 1"	940 mm	3	18.404 SF	1.710 m ²
E74	ST-5	1' - 6 7/16"	468 mm	2' - 1 3/8"	645 mm	3	9.747 SF	0.906 m ²
E76	ST-5	1' - 6 7/16"	468 mm	2' - 1 7/16"	646 mm	4	13.028 SF	1.210 m ²
E77	ST-5	1' - 6 7/16"	468 mm	2' - 1 1/2"	648 mm	3	9.795 SF	0.910 m ²
E78	ST-5	1' - 6 7/16"	468 mm	2' - 9"	838 mm	1	4.225 SF	0.393 m ²
E81	ST-5	1' - 6 7/8"	479 mm	2' - 9"	838 mm	8	34.604 SF	3.215 m ²
E83	ST-5	1' - 6 7/16"	468 mm	2' - 1 3/8"	645 mm	2	6.498 SF	0.604 m ²
E84	ST-5	1' - 6 7/16"	468 mm	2' - 1 7/16"	646 mm	4	13.028 SF	1.210 m ²
E85	ST-5	1' - 6 7/16"	468 mm	2' - 1 1/2"	648 mm	2	6.530 SF	0.607 m ²
E87	ST-5	1' - 6 7/16"	468 mm	2' - 9"	838 mm	2	8.451 SF	0.785 m ²
E88	ST-5	2' - 0"	610 mm	2' - 1 3/8"	645 mm	6	25.375 SF	2.357 m ²
E89	ST-5	2' - 0"	610 mm	2' - 1 7/16"	646 mm	7	29.677 SF	2.757 m ²
E90	ST-5	2' - 0"	610 mm	2' - 1 1/2"	648 mm	6	25.500 SF	2.369 m ²
E91	ST-5	2' - 0"	610 mm	2' - 9"	838 mm	3	16.500 SF	1.533 m ²
E103	ST-5	2' - 0"	610 mm	7 11/16"	195 mm	2	2.563 SF	0.238 m ²
E104	ST-5	11 7/8"	302 mm	2' - 1 1/2"	648 mm	2	4.206 SF	0.391 m ²
E108	ST-5	1' - 2 1/4"	361 mm	2' - 1 3/8"	645 mm	1	2.507 SF	0.233 m ²
E109	ST-5	1' - 2 1/4"	361 mm	2' - 1 7/16"	646 mm	2	5.026 SF	0.467 m ²
E110	ST-5	1' - 2 1/4"	361 mm	2' - 1 1/2"	648 mm	1	2.519 SF	0.234 m ²
E111	ST-5	1' - 2 1/4"	361 mm	3' - 1"	940 mm	1	3.655 SF	0.340 m ²
E112	ST-5	1' - 11 7/8"	606 mm	2' - 1 3/8"	645 mm	11	46.279 SF	4.299 m ²
E113	ST-5	1' - 11 7/8"	606 mm	2' - 1 7/16"	646 mm	22	92.785 SF	8.620 m ²
E114	ST-5	1' - 11 7/8"	606 mm	2' - 1 1/2"	648 mm	11	46.507 SF	4.321 m ²
E115	ST-5	1' - 11 7/8"	606 mm	3' - 1"	940 mm	11	67.480 SF	6.269 m ²
E120	ST-5	1' - 10 5/8"	575 mm	2' - 1 3/8"	645 mm	1	3.987 SF	0.370 m ²
E121	ST-5	1' - 10 5/8"	575 mm	2' - 1 7/16"	646 mm	2	7.993 SF	0.743 m ²
E122	ST-5	1' - 10 5/8"	575 mm	2' - 1 1/2"	648 mm	1	4.007 SF	0.372 m ²
E123	ST-5	1' - 10 5/8"	575 mm	3' - 1"	940 mm	1	5.813 SF	0.540 m ²
E128	ST-5	1' - 8 13/16"	529 mm	2' - 1 3/8"	645 mm	1	3.667 SF	0.341 m ²
E129	ST-5	1' - 8 13/16"	529 mm	2' - 1 7/16"	646 mm	2	7.353 SF	0.683 m ²
E130	ST-5	1' - 11 9/16"	598 mm	2' - 1 3/8"	645 mm	1	4.148 SF	0.385 m ²
E131	ST-5	1' - 11 9/16"	598 mm	2' - 1 7/16"	646 mm	2	8.316 SF	0.773 m ²
Grand total						147	635.013 SF	58.995 m ²

Abbreviations
FE - Finished Edge QME - Quirk Mitre Edge

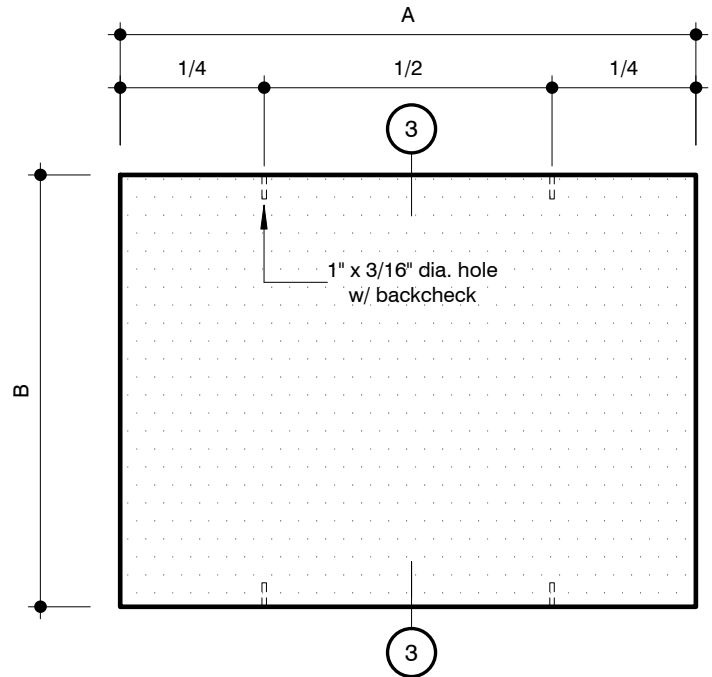

Stone Project Example

6250 Westpark Suite 218 Houston Texas 77057

Date: 02/15/09

Material: Tan Brown Granite

Finish: Polished

Thickness: 2cm

Ticket Number: **TE1**

Mark	Stone Type	A		B		Quantity	Area	
		Imperial	Metric	Imperial	Metric		Imperial	Metric
E132	ST-5	1' - 11 9/16"	598 mm	2' - 1 1/2"	648 mm	1	4.168 SF	0.387 m ²
E133	ST-5	1' - 11 9/16"	598 mm	3' - 1"	940 mm	1	6.048 SF	0.562 m ²
E134	ST-5	1' - 8 13/16"	529 mm	2' - 1 1/2"	648 mm	1	3.686 SF	0.342 m ²
E135	ST-5	1' - 8 13/16"	529 mm	3' - 1"	940 mm	1	5.348 SF	0.497 m ²
E136	ST-5	1' - 8 13/16"	529 mm	2' - 1 3/8"	645 mm	1	3.667 SF	0.341 m ²
E137	ST-5	1' - 8 13/16"	529 mm	2' - 1 7/16"	646 mm	2	7.353 SF	0.683 m ²
E138	ST-5	1' - 8 13/16"	529 mm	2' - 1 1/2"	648 mm	1	3.686 SF	0.342 m ²
E139	ST-5	1' - 8 13/16"	529 mm	3' - 1"	940 mm	1	5.348 SF	0.497 m ²
E141	ST-5	1' - 6 3/8"	467 mm	2' - 1 3/8"	645 mm	2	6.476 SF	0.602 m ²
E142	ST-5	1' - 6 3/8"	467 mm	2' - 1 7/16"	646 mm	2	6.492 SF	0.603 m ²
E143	ST-5	1' - 6 3/8"	467 mm	2' - 1 1/2"	648 mm	2	6.508 SF	0.605 m ²
E151	ST-5	2' - 5 5/16"	745 mm	3' - 1"	940 mm	2	15.063 SF	1.399 m ²
E160	ST-5	1' - 11 13/16"	605 mm	2' - 1 3/8"	645 mm	2	8.392 SF	0.780 m ²
E161	ST-5	1' - 11 13/16"	605 mm	2' - 1 7/16"	646 mm	4	16.826 SF	1.563 m ²
E162	ST-5	1' - 11 13/16"	605 mm	2' - 1 1/2"	648 mm	2	8.434 SF	0.784 m ²
E163	ST-5	2' - 5 7/8"	759 mm	2' - 1 7/16"	646 mm	2	10.555 SF	0.981 m ²
E164	ST-5	2' - 5 7/8"	759 mm	2' - 1 1/2"	648 mm	2	10.581 SF	0.983 m ²
E167	ST-5	1' - 2 3/8"	365 mm	2' - 1 3/8"	645 mm	2	5.066 SF	0.471 m ²
E184	ST-5	1' - 6 3/8"	467 mm	2' - 3 3/16"	691 mm	2	6.938 SF	0.645 m ²
E187	ST-5	2' - 0"	610 mm	2' - 3 3/16"	691 mm	3	13.594 SF	1.263 m ²
E188	ST-5	1' - 6 7/16"	468 mm	2' - 3 3/16"	691 mm	2	6.962 SF	0.647 m ²
Grand total						38	161.190 SF	14.975 m ²

Abbreviations
FE - Finished Edge QME - Quirk Mitre Edge

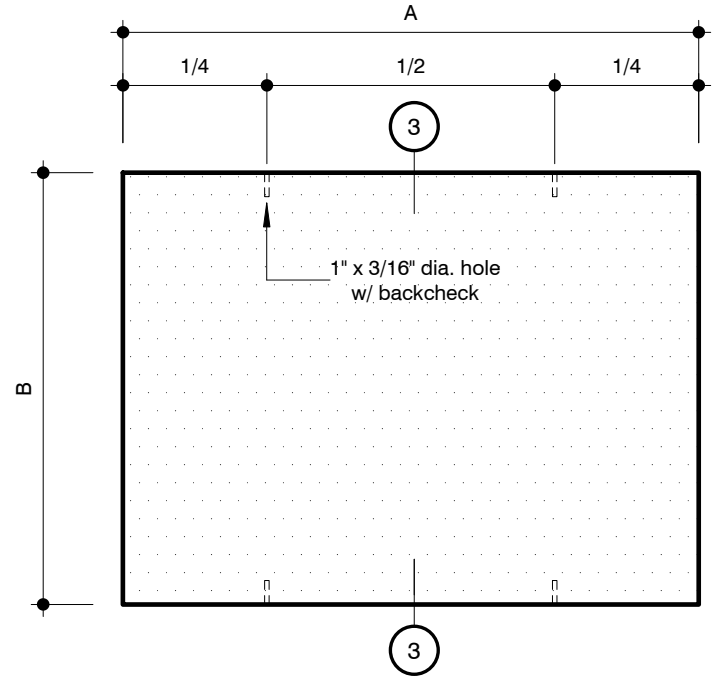

Stone Project Example

6250 Westpark Suite 218 Houston Texas 77057

Date: 02/26/09

Material: Tan Brown Granite

Finish: Polished

Thickness: 2cm

Ticket Number: **TE2**

Mark	Stone Type	A		B		Quantity	Area	
		Imperial	Metric	Imperial	Metric		Imperial	Metric
E36	ST-5	1' - 5 1/2"	445 mm	1' - 11 3/8"	594 mm	1	2.841 SF	0.264 m ²
E37	ST-5	1' - 5 1/2"	445 mm	2' - 1 3/8"	645 mm	12	37.005 SF	3.438 m ²
E38	ST-5	1' - 5 1/2"	445 mm	2' - 1 9/16"	650 mm	6	18.656 SF	1.733 m ²
E39	ST-5	1' - 5 1/2"	445 mm	3' - 1 1/16"	941 mm	6	27.008 SF	2.509 m ²
E40	ST-5	1' - 5 1/2"	445 mm	2' - 4 1/16"	712 mm	1	3.408 SF	0.317 m ²
E41	ST-5	1' - 5 1/2"	445 mm	2' - 8 11/16"	831 mm	1	3.976 SF	0.369 m ²
E42	ST-5	1' - 5 1/2"	445 mm	3' - 1 3/8"	950 mm	1	4.543 SF	0.422 m ²
E43	ST-5	1' - 5 1/2"	445 mm	3' - 5 3/8"	1051 mm	2	10.056 SF	0.934 m ²
Grand total						30	107.493 SF	9.986 m ²

Abbreviations
 FE - Finished Edge QME - Quirk Mitre Edge

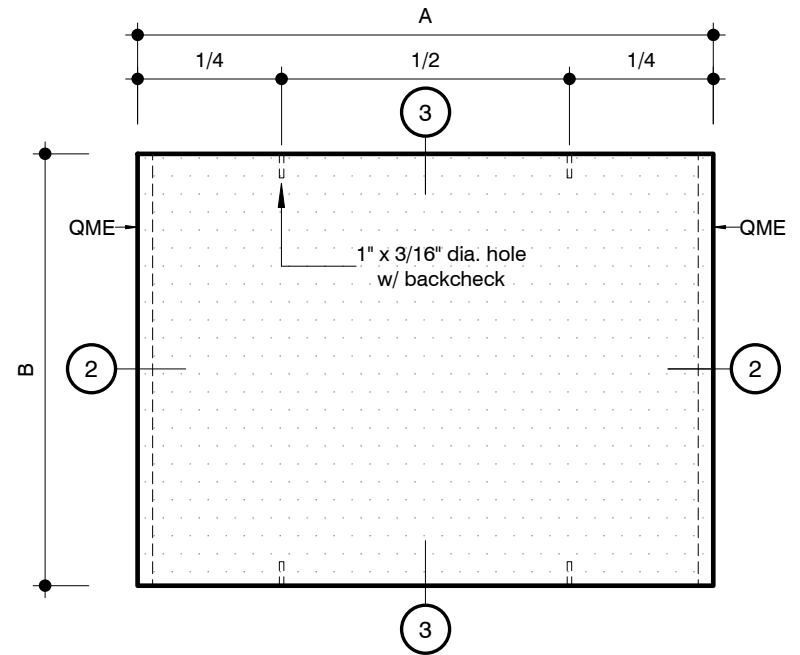

Stone Project Example

6250 Westpark Suite 218 Houston Texas 77057

Date: 02/15/09

Material: Tan Brown Granite

Finish: Polished

Thickness: 2cm

Ticket Number: **TE3**

Mark	Stone Type	A		B		Quantity	Area	
		Imperial	Metric	Imperial	Metric		Imperial	Metric
E66	ST-5	2' - 8 7/16"	824 mm	2' - 1 3/8"	645 mm	6	34.296 SF	3.186 m ²
E68	ST-5	3' - 3 1/2"	1003 mm	2' - 1 3/8"	645 mm	2	13.921 SF	1.293 m ²
E75	ST-5	1' - 6 5/8"	473 mm	2' - 1 3/8"	645 mm	16	52.512 SF	4.879 m ²
E79	ST-5	1' - 6 5/8"	473 mm	2' - 1 7/16"	646 mm	20	65.802 SF	6.113 m ²
E80	ST-5	1' - 6 5/8"	473 mm	2' - 1 1/2"	648 mm	16	52.771 SF	4.903 m ²
E86	ST-5	2' - 11"	889 mm	2' - 1 3/8"	645 mm	2	12.335 SF	1.146 m ²
E92	ST-5	1' - 6 3/16"	462 mm	2' - 1 3/8"	645 mm	1	3.205 SF	0.298 m ²
E93	ST-5	1' - 6 3/16"	462 mm	2' - 1 7/16"	646 mm	2	6.426 SF	0.597 m ²
E94	ST-5	1' - 6 3/16"	462 mm	2' - 1 1/2"	648 mm	1	3.221 SF	0.299 m ²
E95	ST-5	1' - 6 3/16"	462 mm	2' - 9"	838 mm	1	4.168 SF	0.387 m ²
E99	ST-5	9 3/4"	248 mm	2' - 1 3/8"	645 mm	16	27.490 SF	2.554 m ²
E100	ST-5	9 3/4"	248 mm	2' - 1 7/16"	646 mm	24	41.336 SF	3.840 m ²
E101	ST-5	9 3/4"	248 mm	2' - 1 1/2"	648 mm	16	27.625 SF	2.566 m ²
E116	ST-5	2' - 0 3/16"	614 mm	2' - 1 3/8"	645 mm	1	4.262 SF	0.396 m ²
E117	ST-5	2' - 0 3/16"	614 mm	2' - 1 7/16"	646 mm	2	8.545 SF	0.794 m ²
E118	ST-5	2' - 0 3/16"	614 mm	2' - 1 1/2"	648 mm	1	4.283 SF	0.398 m ²
E119	ST-5	2' - 0 3/16"	614 mm	3' - 1"	940 mm	1	6.215 SF	0.577 m ²
E124	ST-5	1' - 11 5/8"	600 mm	2' - 1 3/8"	645 mm	2	8.326 SF	0.774 m ²
E125	ST-5	1' - 11 5/8"	600 mm	2' - 1 7/16"	646 mm	4	16.693 SF	1.551 m ²
E126	ST-5	1' - 11 5/8"	600 mm	2' - 1 1/2"	648 mm	2	8.367 SF	0.777 m ²
E127	ST-5	1' - 11 5/8"	600 mm	3' - 1"	940 mm	2	12.141 SF	1.128 m ²
E140	ST-5	2' - 0 5/8"	625 mm	2' - 1 3/8"	645 mm	2	8.679 SF	0.806 m ²
E148	ST-5	2' - 5 1/16"	738 mm	2' - 1 3/8"	645 mm	2	10.243 SF	0.952 m ²
E149	ST-5	2' - 5 1/16"	738 mm	2' - 1 7/16"	646 mm	4	20.535 SF	1.908 m ²
E150	ST-5	2' - 5 1/16"	738 mm	2' - 1 1/2"	648 mm	2	10.293 SF	0.956 m ²
E183	ST-5	9 3/4"	248 mm	2' - 2 1/16"	662 mm	8	14.117 SF	1.312 m ²
E186	ST-5	1' - 6 5/8"	473 mm	2' - 3 3/16"	691 mm	4	14.066 SF	1.307 m ²
Grand total						160	491.872 SF	45.696 m ²

Abbreviations
FE - Finished Edge QME - Quirk Mitre Edge

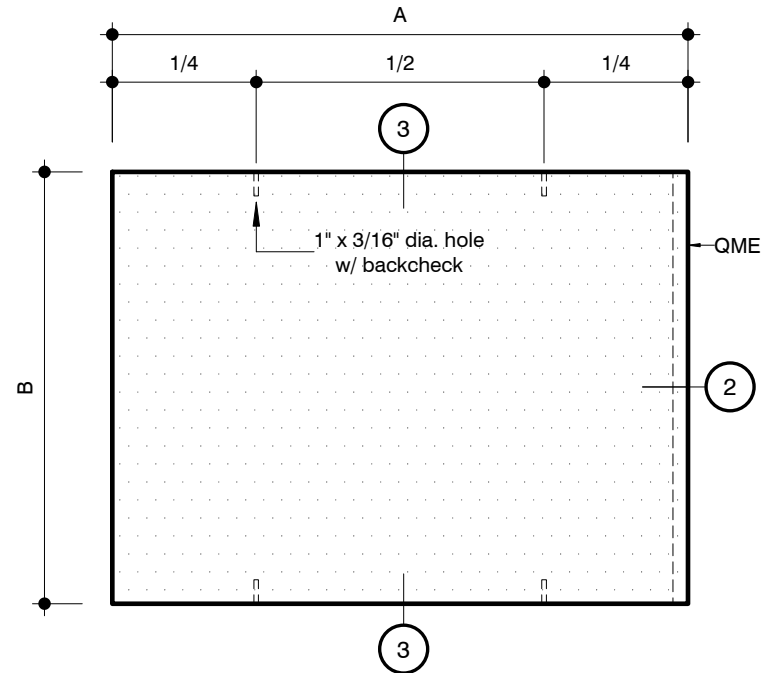

Stone Project Example

6250 Westpark Suite 218 Houston Texas 77057

Date: 02/15/09

Material: Tan Brown Granite

Finish: Polished

Thickness: 2cm

Ticket Number: **TE4**

Mark	Stone Type	A		B		Quantity	Area	
		Imperial	Metric	Imperial	Metric		Imperial	Metric
E45	ST-5	9 3/8"	238 mm	3' - 5 3/8"	1051 mm	3	8.081 SF	0.751 m ²
E46	ST-5	9 3/8"	238 mm	2' - 1 3/8"	645 mm	22	36.344 SF	3.377 m ²
E47	ST-5	9 3/8"	238 mm	2' - 1 9/16"	650 mm	11	18.323 SF	1.702 m ²
E48	ST-5	9 3/8"	238 mm	3' - 1 1/16"	941 mm	11	26.525 SF	2.464 m ²
E51	ST-5	9 3/8"	238 mm	3' - 1 3/8"	950 mm	2	4.868 SF	0.452 m ²
E53	ST-5	9 3/8"	238 mm	2' - 8 11/16"	831 mm	2	4.260 SF	0.396 m ²
E55	ST-5	9 3/8"	238 mm	2' - 4 1/16"	712 mm	2	3.651 SF	0.339 m ²
E57	ST-5	9 3/8"	238 mm	1' - 11 3/8"	594 mm	2	3.044 SF	0.283 m ²
E59	ST-5	10 5/16"	261 mm	3' - 5 3/8"	1051 mm	1	2.956 SF	0.275 m ²
E60	ST-5	10 5/16"	261 mm	2' - 1 3/8"	645 mm	2	3.626 SF	0.337 m ²
E61	ST-5	10 5/16"	261 mm	2' - 1 9/16"	650 mm	1	1.828 SF	0.170 m ²
E62	ST-5	10 5/16"	261 mm	3' - 1 1/16"	941 mm	1	2.647 SF	0.246 m ²
E105	ST-5	2' - 11"	889 mm	2' - 1 7/16"	646 mm	4	24.731 SF	2.298 m ²
E106	ST-5	2' - 11"	889 mm	2' - 1 1/2"	648 mm	2	12.396 SF	1.152 m ²
E107	ST-5	2' - 10 15/16"	887 mm	3' - 1"	940 mm	2	17.954 SF	1.668 m ²
Grand total						68	171.234 SF	15.908 m ²

Abbreviations
 FE - Finished Edge QME - Quirk Mitre Edge

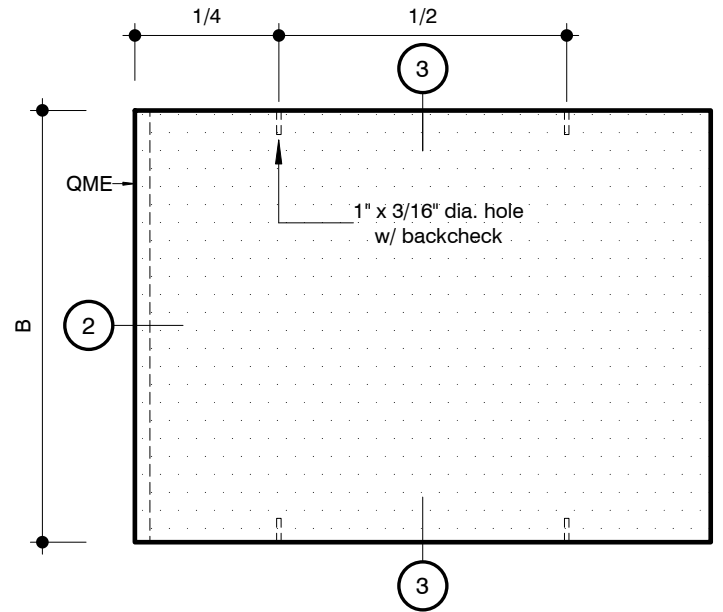

Stone Project Example

6250 Westpark Suite 218 Houston Texas 77057

Date: 02/15/09

Material: Tan Brown Granite

Finish: Polished

Thickness: 2cm

Ticket Number: **TE5**

Mark	Stone Type	A		B		Quantity	Area	
		Imperial	Metric	Imperial	Metric		Imperial	Metric
E102	ST-5	2' - 0"	610 mm	7 3/4"	197 mm	2	2.583 SF	0.240 m ²
Grand total						2	2.583 SF	0.240 m ²

Abbreviations
 FE - Finished Edge QME - Quirk Mitre Edge

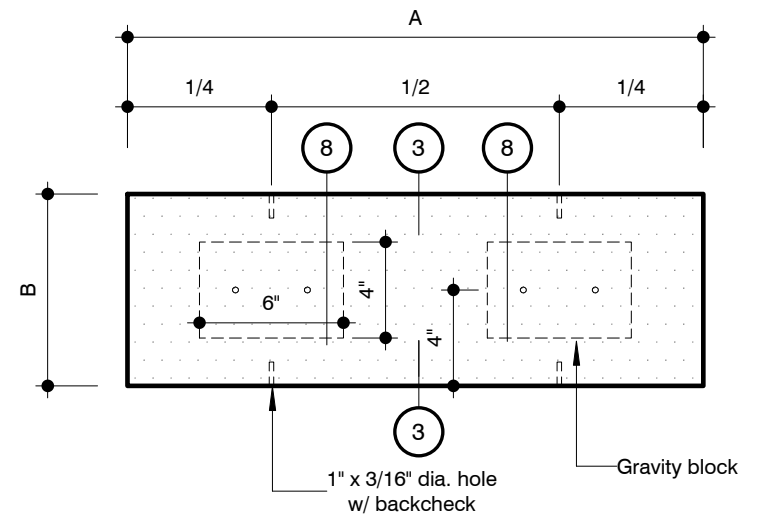

Stone Project Example

6250 Westpark Suite 218 Houston Texas 77057

Date: 02/26/09

Material: Tan Brown Granite

Finish: Polished

Thickness: 2cm

Ticket Number: **TE6**

Mark	Stone Type	A		B		Quantity	Area	
		Imperial	Metric	Imperial	Metric		Imperial	Metric
E72	ST-5	1' - 11 7/8"	606 mm	2' - 1 7/16"	646 mm	3	12.653 SF	1.175 m ²
Grand total						3	12.653 SF	1.175 m ²

Abbreviations
 FE - Finished Edge QME - Quirk Mitre Edge

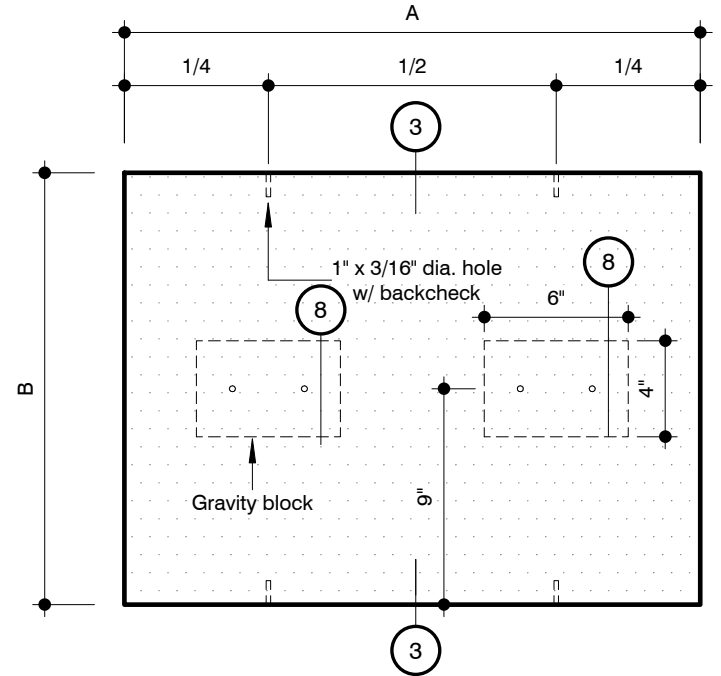

Stone Project Example

6250 Westpark Suite 218 Houston Texas 77057

Date: 02/26/09

Material: Tan Brown Granite

Finish: Polished

Thickness: 2cm

Ticket Number: **TE7**

Mark	Stone Type	A		B		Quantity	Area	
		Imperial	Metric	Imperial	Metric		Imperial	Metric
E147	ST-5	1' - 9 1/16"	535 mm	1' - 0 3/4"	324 mm	8	14.919 SF	1.386 m ²
Grand total						8	14.919 SF	1.386 m ²

Abbreviations
 FE - Finished Edge QME - Quirk Mitre Edge

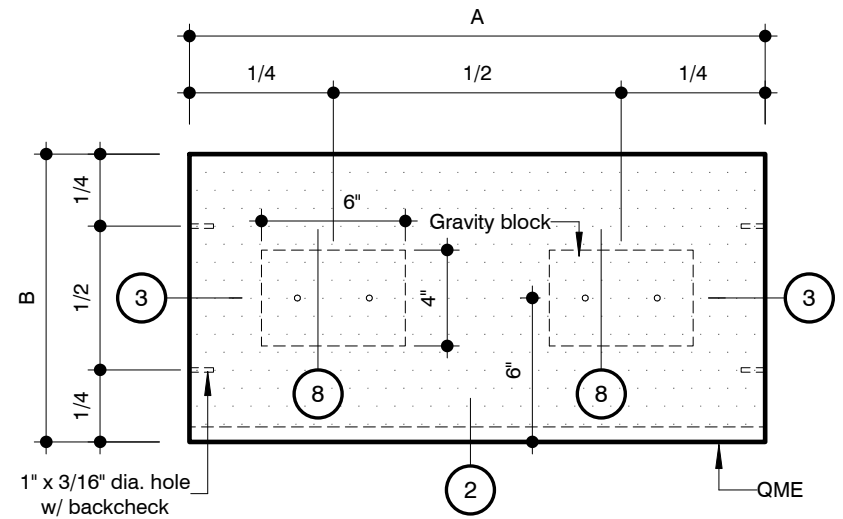

Stone Project Example

6250 Westpark Suite 218 Houston Texas 77057

Date: 02/26/09

Material: Tan Brown Granite

Finish: Polished

Thickness: 2cm

Ticket Number: **TE8**

Mark	Stone Type	A		B		Quantity	Area	
		Imperial	Metric	Imperial	Metric		Imperial	Metric
E82	ST-5	1' - 8 13/16"	529 mm	3' - 0 3/4"	933 mm	8	42.492 SF	3.948 m ²
E152	ST-5	1' - 11 13/16"	605 mm	3' - 0 3/4"	933 mm	2	12.154 SF	1.129 m ²
E153	ST-5	2' - 5 7/8"	759 mm	3' - 0 3/4"	933 mm	2	15.249 SF	1.417 m ²
Grand total						12	69.895 SF	6.493 m ²

Abbreviations
 FE - Finished Edge QME - Quirk Mitre Edge

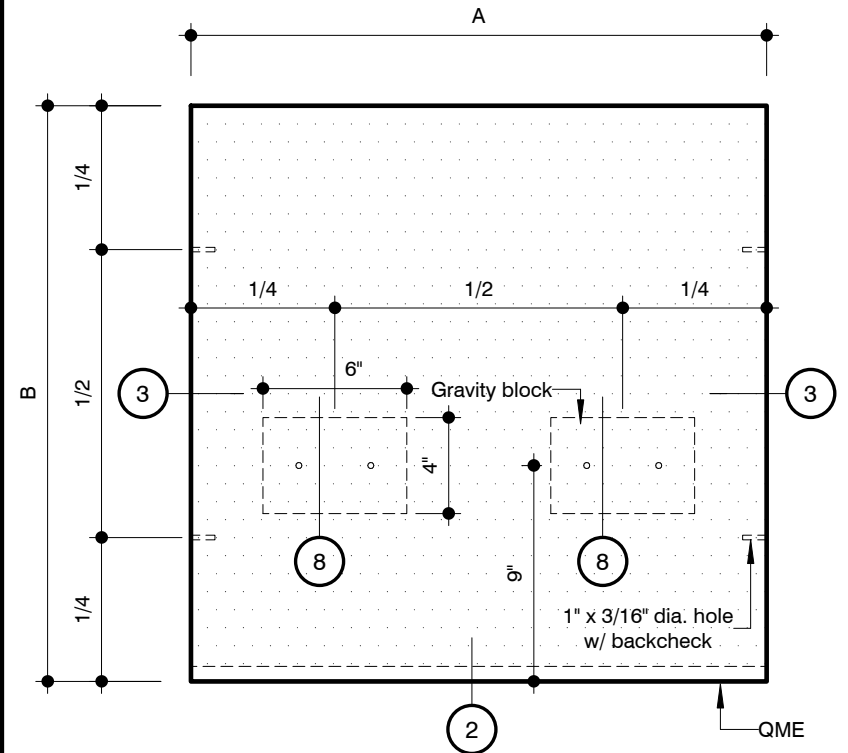

Stone Project Example

6250 Westpark Suite 218 Houston Texas 77057

Date: 02/26/09

Material: Tan Brown Granite

Finish: Polished

Thickness: 2cm

Ticket Number: **TE9**

Mark	Stone Type	A		B		Quantity	Area	
		Imperial	Metric	Imperial	Metric		Imperial	Metric
E96	ST-5	1' - 9 11/16"	551 mm	9 3/4"	248 mm	16	23.495 SF	2.183 m ²
Grand total						16	23.495 SF	2.183 m ²

Abbreviations
 FE - Finished Edge QME - Quirk Mitre Edge

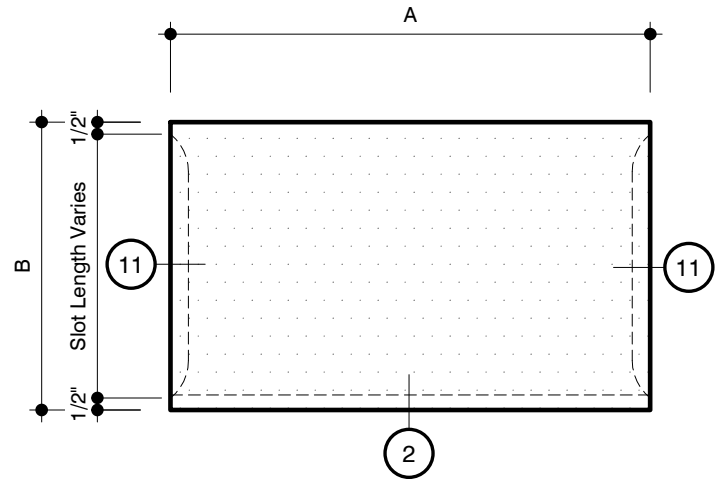

Stone Project Example

6250 Westpark Suite 218 Houston Texas 77057

Date: 02/26/09

Material: Tan Brown Granite

Finish: Polished

Thickness: 2cm

Ticket Number: **TE10**

Mark	Stone Type	A		B		Quantity	Area	
		Imperial	Metric	Imperial	Metric		Imperial	Metric
E154	ST-5	9"	229 mm	2' - 1 3/8"	645 mm	2	3.172 SF	0.295 m ²
E155	ST-5	9"	229 mm	2' - 1 7/16"	646 mm	4	6.359 SF	0.591 m ²
E156	ST-5	9"	229 mm	2' - 1 1/2"	648 mm	2	3.188 SF	0.296 m ²
Grand total						8	12.719 SF	1.182 m ²

Abbreviations
 FE - Finished Edge QME - Quirk Mitre Edge

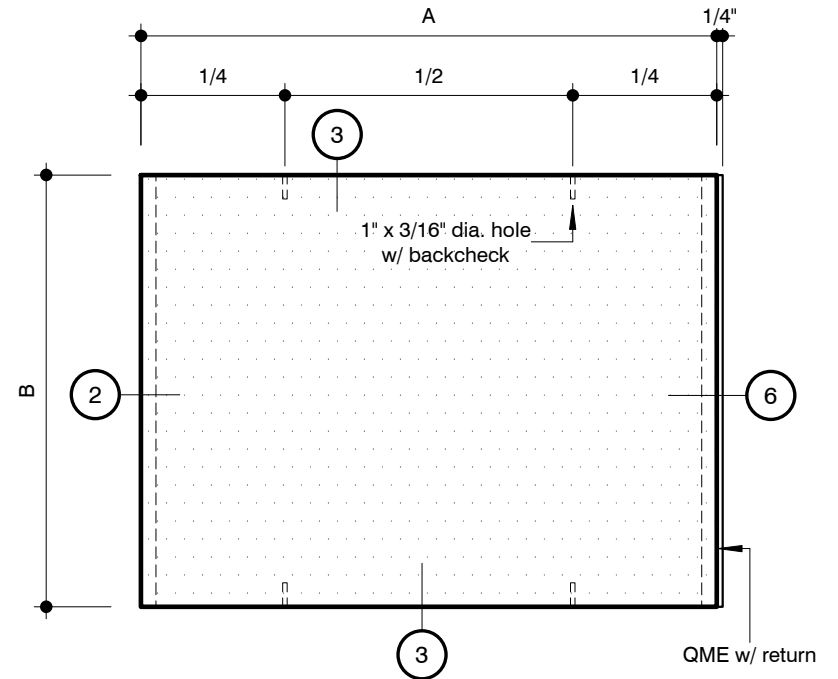

Stone Project Example

6250 Westpark Suite 218 Houston Texas 77057

Date: 02/26/09

Material: Tan Brown Granite

Finish: Polished

Thickness: 2cm

Ticket Number: **TE11**

Mark	Stone Type	A		B		Quantity	Area	
		Imperial	Metric	Imperial	Metric		Imperial	Metric
E157	ST-5	1' - 9 3/16"	538 mm	2' - 1 3/8"	645 mm	2	7.459 SF	0.693 m ²
E158	ST-5	1' - 9 3/16"	538 mm	2' - 1 7/16"	646 mm	4	14.954 SF	1.389 m ²
E159	ST-5	1' - 9 3/16"	538 mm	2' - 1 1/2"	648 mm	2	7.496 SF	0.696 m ²
Grand total						8	29.909 SF	2.779 m ²

Abbreviations
 FE - Finished Edge QME - Quirk Mitre Edge

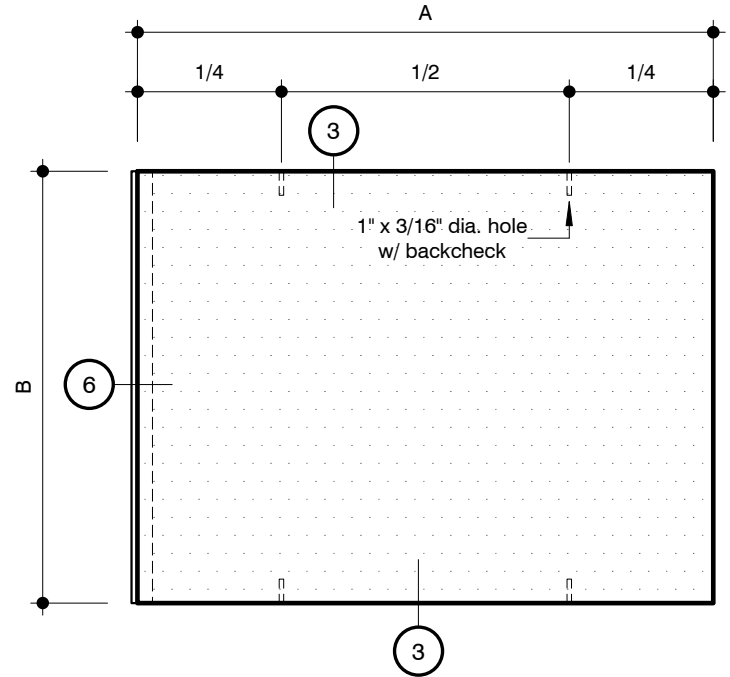

Stone Project Example

6250 Westpark Suite 218 Houston Texas 77057

Date: 02/26/09

Material: Tan Brown Granite

Finish: Polished

Thickness: 2cm

Ticket Number: **TE12**

Mark	Stone Type	A		B		Quantity	Area	
		Imperial	Metric	Imperial	Metric		Imperial	Metric
E16	ST-5	2' - 1 7/16"	646 mm	6 3/4"	171 mm	4	4.770 SF	0.443 m ²
E17	ST-5	2' - 1 3/8"	645 mm	6 3/4"	171 mm	1	1.189 SF	0.111 m ²
E23	ST-5	2' - 1 7/16"	646 mm	5 1/8"	130 mm	4	3.621 SF	0.336 m ²
E24	ST-5	2' - 1 3/8"	645 mm	5 1/8"	130 mm	1	0.903 SF	0.084 m ²
Grand total						10	10.483 SF	0.974 m ²

Abbreviations
 FE - Finished Edge QME - Quirk Mitre Edge

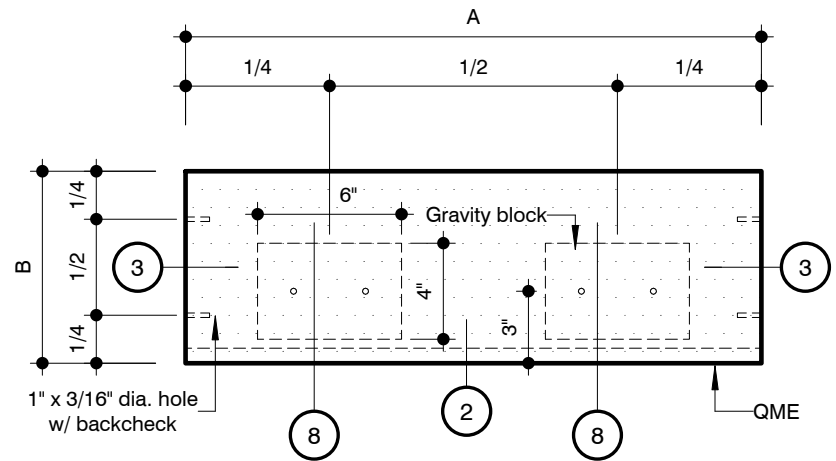

Stone Project Example

6250 Westpark Suite 218 Houston Texas 77057

Date: 02/15/09

Material: Tan Brown Granite

Finish: Polished

Thickness: 2cm

Ticket Number: **TE13**

Mark	Stone Type	A		B		Quantity	Area	
		Imperial	Metric	Imperial	Metric		Imperial	Metric
E30	ST-5	1' - 11 13/16"	605 mm	6 3/4"	171 mm	1	1.116 SF	0.104 m ²
Grand total						1	1.116 SF	0.104 m ²

Abbreviations
 FE - Finished Edge QME - Quirk Mitre Edge

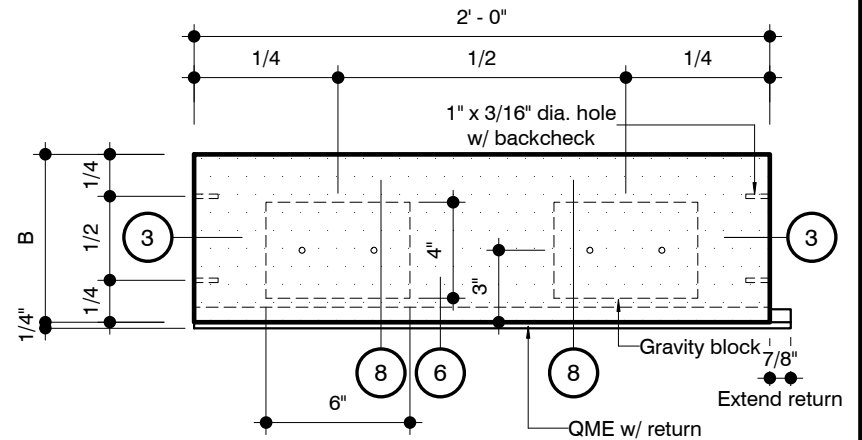

Stone Project Example

6250 Westpark Suite 218 Houston Texas 77057

Date: 02/15/09

Material: Tan Brown Granite

Finish: Polished

Thickness: 2cm

Ticket Number: **TE14**

Mark	Stone Type	A		B		Quantity	Area	
		Imperial	Metric	Imperial	Metric		Imperial	Metric
E181	ST-5	7"	178 mm	6 7/8"	174 mm	2	0.668 SF	0.062 m ²
Grand total						2	0.668 SF	0.062 m ²

Abbreviations
 FE - Finished Edge QME - Quirk Mitre Edge

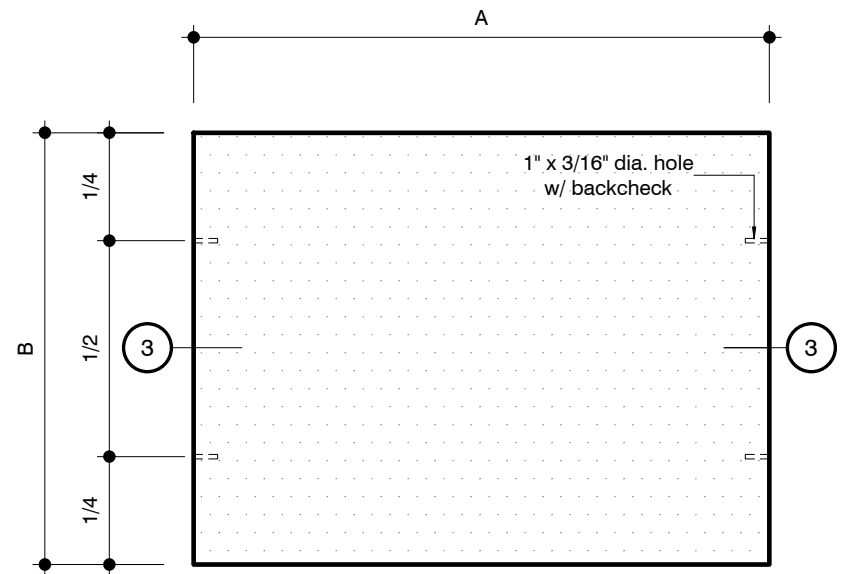

Stone Project Example

6250 Westpark Suite 218 Houston Texas 77057

Date: 02/15/09

Material: Tan Brown Granite

Finish: Polished

Thickness: 2cm

Ticket Number: **TE15**

Mark	Stone Type	A		B		Quantity	Area	
		Imperial	Metric	Imperial	Metric		Imperial	Metric
E180	ST-5	1' - 11 13/16"	605 mm	6 3/4"	171 mm	1	1.116 SF	0.104 m ²
Grand total						1	1.116 SF	0.104 m ²

Abbreviations
 FE - Finished Edge QME - Quirk Mitre Edge

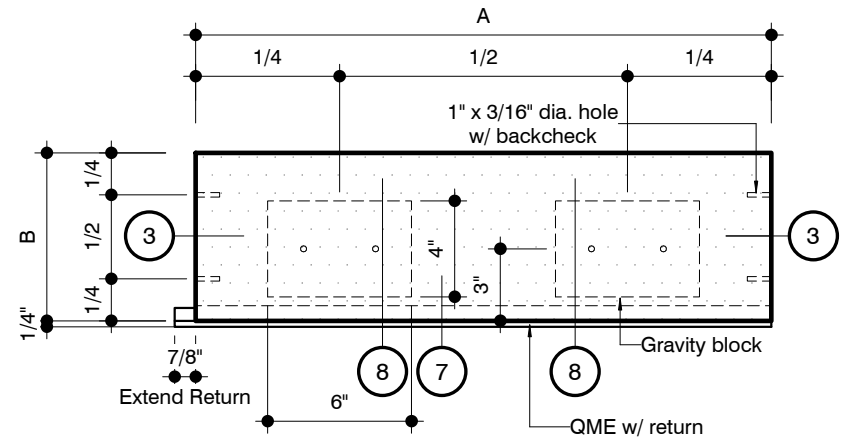

Stone Project Example

6250 Westpark Suite 218 Houston Texas 77057

Date: 02/19/09

Material: Tan Brown Granite

Finish: Polished

Thickness: 2cm

Ticket Number: **TE16**

Mark	Stone Type	A		B		Quantity	Area	
		Imperial	Metric	Imperial	Metric		Imperial	Metric
E8	ST-5	2' - 1 1/2"	648 mm	11 1/2"	292 mm	2	4.073 SF	0.378 m ²
E9	ST-5	2' - 1 7/16"	646 mm	11 1/2"	292 mm	2	4.063 SF	0.377 m ²
E10	ST-5	2' - 1 3/4"	654 mm	11 1/2"	292 mm	2	4.113 SF	0.382 m ²
E11	ST-5	1' - 7 11/16"	500 mm	11 1/2"	292 mm	2	3.145 SF	0.292 m ²
E171	ST-5	1' - 7 11/16"	500 mm	8 3/4"	222 mm	2	2.393 SF	0.222 m ²
E176	ST-5	2' - 1 3/4"	654 mm	8 3/4"	222 mm	2	3.129 SF	0.291 m ²
E177	ST-5	2' - 1 7/16"	646 mm	8 3/4"	222 mm	2	3.091 SF	0.287 m ²
E178	ST-5	2' - 1 1/2"	648 mm	8 3/4"	222 mm	2	3.099 SF	0.288 m ²
Grand total						16	27.105 SF	2.518 m ²

Abbreviations
 FE - Finished Edge QME - Quirk Mitre Edge

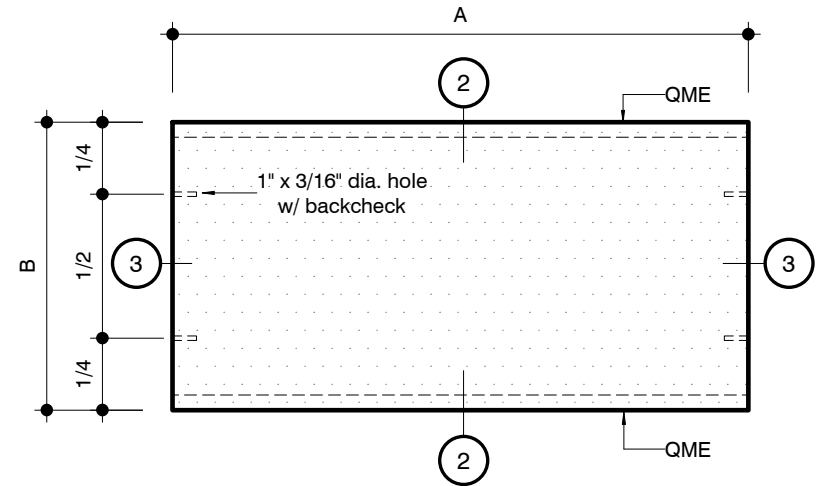

Stone Project Example

6250 Westpark Suite 218 Houston Texas 77057

Date: 02/19/09

Material: Tan Brown Granite

Finish: Polished

Thickness: 2cm

Ticket Number: **TE17**

Mark	Stone Type	A		B		Quantity	Area	
		Imperial	Metric	Imperial	Metric		Imperial	Metric
E12	ST-5	2' - 1 1/2"	648 mm	5 5/8"	143 mm	4	3.984 SF	0.370 m ²
E13	ST-5	2' - 1 7/16"	646 mm	5 5/8"	143 mm	4	3.975 SF	0.369 m ²
E14	ST-5	2' - 1 3/4"	654 mm	5 5/8"	143 mm	4	4.023 SF	0.374 m ²
E15	ST-5	1' - 7 11/16"	500 mm	5 5/8"	143 mm	4	3.076 SF	0.286 m ²
E18	ST-5	2' - 1 1/2"	648 mm	7 5/8"	194 mm	2	2.701 SF	0.251 m ²
E19	ST-5	2' - 1 7/16"	646 mm	7 5/8"	194 mm	2	2.694 SF	0.250 m ²
E20	ST-5	2' - 1 3/4"	654 mm	7 5/8"	194 mm	2	2.727 SF	0.253 m ²
E21	ST-5	1' - 7 11/16"	500 mm	7 5/8"	194 mm	2	2.085 SF	0.194 m ²
E31	ST-5	1' - 7 11/16"	500 mm	6 9/16"	166 mm	2	1.788 SF	0.166 m ²
E32	ST-5	2' - 1 3/4"	654 mm	6 9/16"	166 mm	2	2.339 SF	0.217 m ²
E33	ST-5	2' - 1 7/16"	646 mm	6 9/16"	166 mm	2	2.310 SF	0.215 m ²
E34	ST-5	2' - 1 1/2"	648 mm	6 9/16"	166 mm	2	2.316 SF	0.215 m ²
E63	ST-5	1' - 10 5/8"	575 mm	2' - 1 3/8"	645 mm	2	7.974 SF	0.741 m ²
E169	ST-5	2' - 0 11/16"	627 mm	3 7/8"	98 mm	2	1.329 SF	0.123 m ²
E170	ST-5	2' - 5 7/8"	759 mm	3 7/8"	98 mm	2	1.608 SF	0.149 m ²
Grand total						38	44.928 SF	4.174 m ²

Abbreviations
FE - Finished Edge QME - Quirk Mitre Edge

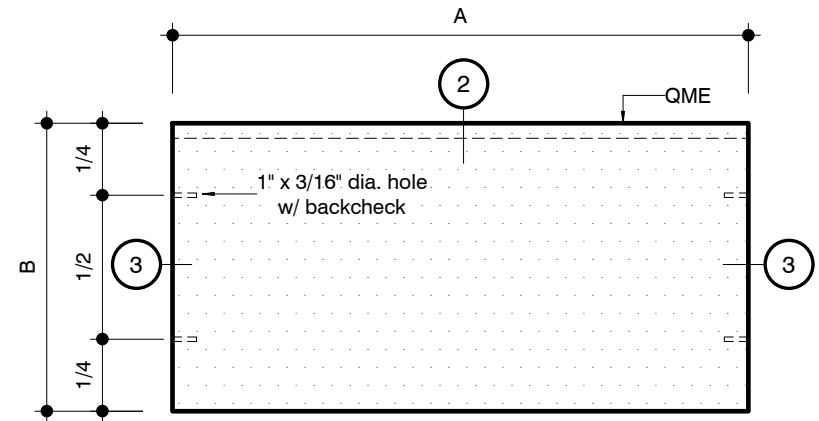

Stone Project Example

6250 Westpark Suite 218 Houston Texas 77057

Date: 02/19/09

Material: Tan Brown Granite

Finish: Polished

Thickness: 2cm

Ticket Number: **TE18**

Mark	Stone Type	A		B		Quantity	Area	
		Imperial	Metric	Imperial	Metric		Imperial	Metric
E25	ST-5	1' - 8 3/16"	513 mm	11 1/2"	292 mm	2	3.224 SF	0.300 m ²
E26	ST-5	2' - 1 7/16"	646 mm	11 1/2"	292 mm	4	8.126 SF	0.755 m ²
E27	ST-5	2' - 1 3/8"	645 mm	11 1/2"	292 mm	1	2.026 SF	0.188 m ²
E179	ST-5	2' - 0 9/16"	624 mm	8 3/4"	222 mm	2	2.985 SF	0.277 m ²
Grand total						9	16.362 SF	1.520 m ²

Abbreviations
 FE - Finished Edge QME - Quirk Mitre Edge

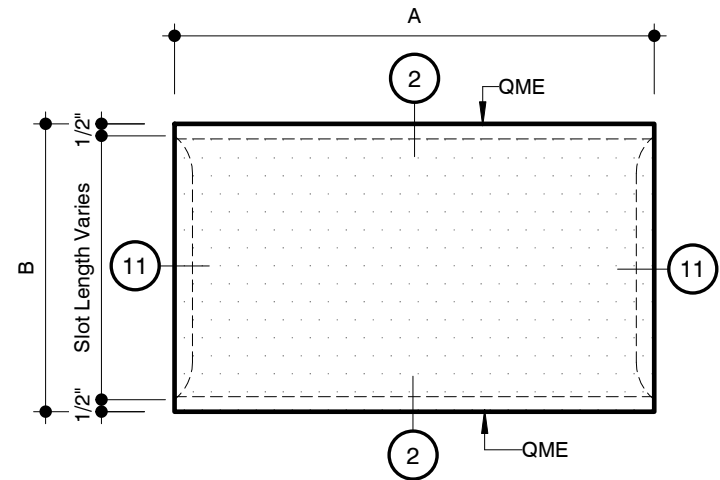

Stone Project Example

6250 Westpark Suite 218 Houston Texas 77057

Date: 02/19/09

Material: Tan Brown Granite

Finish: Polished

Thickness: 2cm

Ticket Number: **TE19**

Mark	Stone Type	Quantity	Area	
			Imperial	Metric
E174	ST-5	1	1.247 SF	0.116 m ²

Abbreviations
 FE - Finished Edge QME - Quirk Mitre Edge

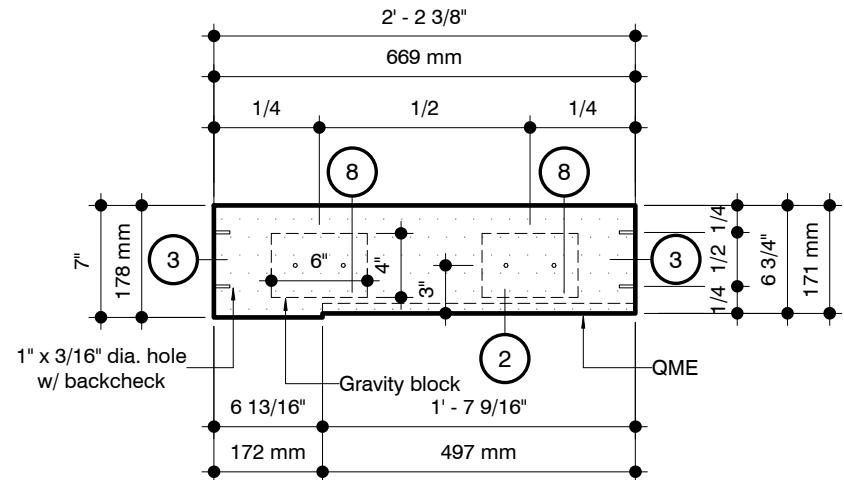

Stone Project Example

6250 Westpark Suite 218 Houston Texas 77057

Date: 02/18/09

Material: Tan Brown Granite

Finish: Polished

Thickness: 2cm

Ticket Number: **TE20**

Mark	Stone Type	Quantity	Area	
			Imperial	Metric
E175	ST-5	1	1.203 SF	0.112 m ²

Abbreviations
 FE - Finished Edge QME - Quirk Mitre Edge

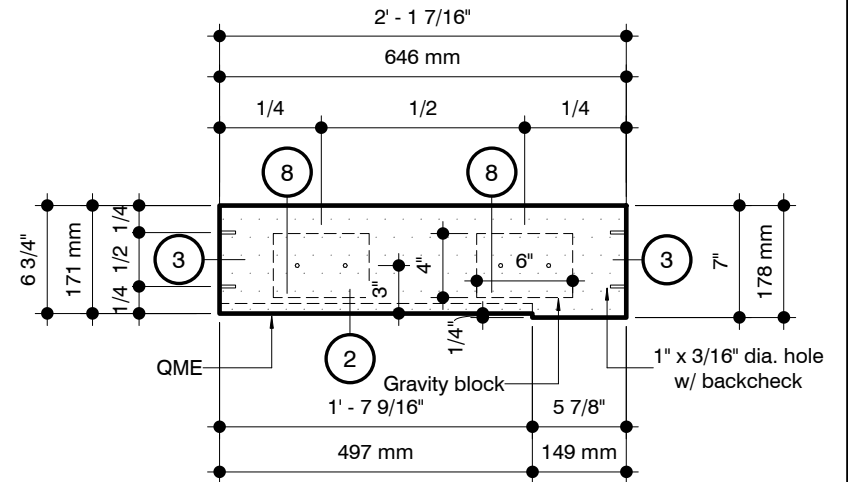

Stone Project Example

6250 Westpark Suite 218 Houston Texas 77057

Date: 02/18/09	Material: Tan Brown Granite	Finish: Polished	Thickness: 2cm	Ticket Number: TE21
----------------	-----------------------------	------------------	----------------	----------------------------

Mark	Stone Type	Quantity	Area	
			Imperial	Metric
E173	ST-5	1	0.916 SF	0.085 m ²

Abbreviations
 FE - Finished Edge QME - Quirk Mitre Edge

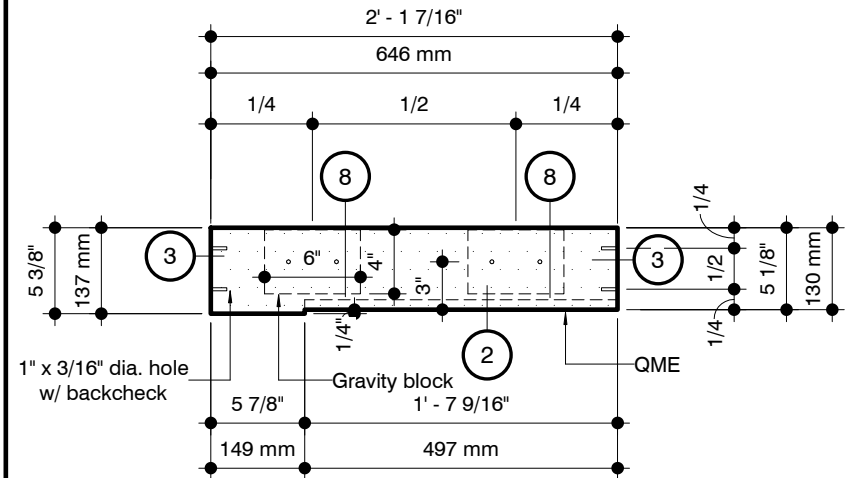

Stone Project Example

6250 Westpark Suite 218 Houston Texas 77057

Date: 02/18/09

Material: Tan Brown Granite

Finish: Polished

Thickness: 2cm

Ticket Number: **TE22**

Mark	Stone Type	Quantity	Area	
			Imperial	Metric
E22	ST-5	1	0.950 SF	0.088 m ²

Abbreviations
 FE - Finished Edge QME - Quirk Mitre Edge

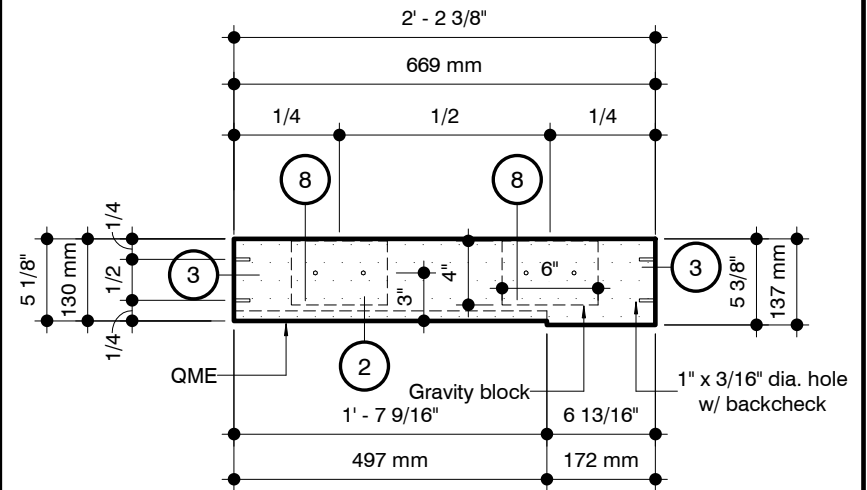

Stone Project Example

6250 Westpark Suite 218 Houston Texas 77057

Date: 02/18/09

Material: Tan Brown Granite

Finish: Polished

Thickness: 2cm

Ticket Number: **TE23**

Mark	Stone Type	Quantity	Area	
			Imperial	Metric
E29	ST-5	1	1.105 SF	0.103 m ²

Abbreviations
 FE - Finished Edge QME - Quirk Mitre Edge

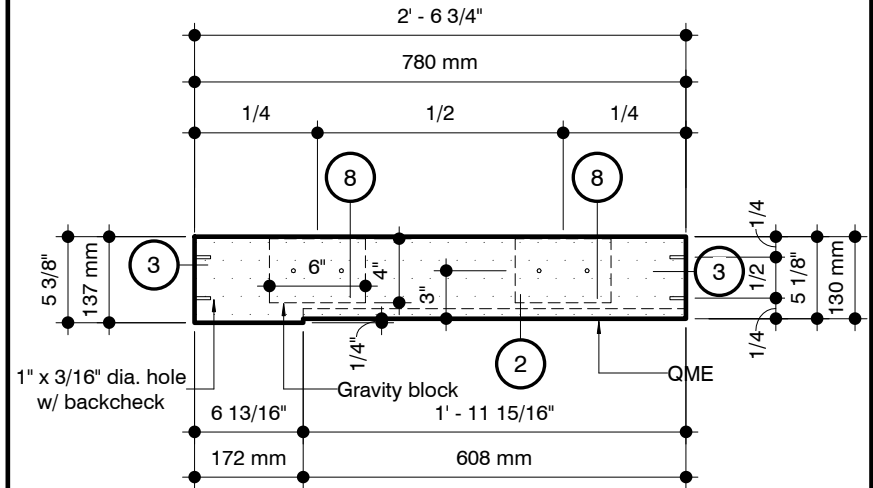

Stone Project Example

6250 Westpark Suite 218 Houston Texas 77057

Date: 02/18/09

Material: Tan Brown Granite

Finish: Polished

Thickness: 2cm

Ticket Number: **TE24**

Mark	Stone Type	Quantity	Area	
			Imperial	Metric
E172	ST-5	1	1.071 SF	0.100 m ²

Abbreviations
 FE - Finished Edge QME - Quirk Mitre Edge

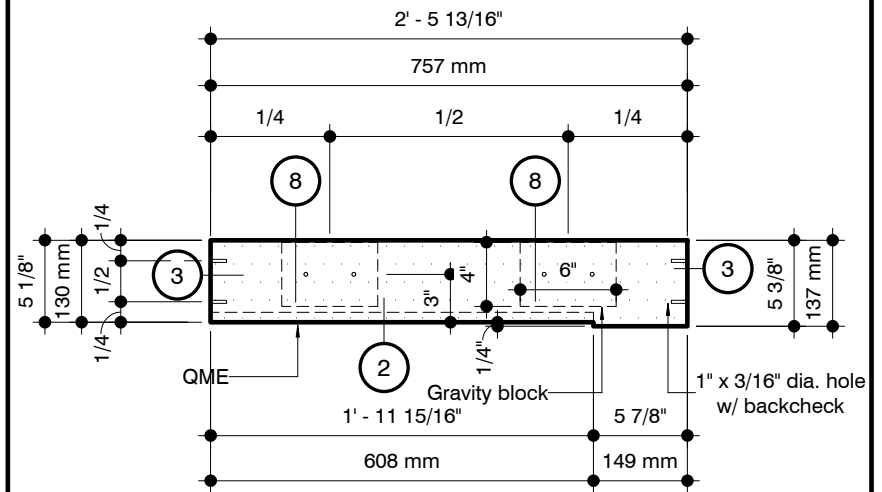

Stone Project Example

6250 Westpark Suite 218 Houston Texas 77057

Date: 02/18/09

Material: Tan Brown Granite

Finish: Polished

Thickness: 2cm

Ticket Number: **TE25**

Mark	Stone Type	Quantity	Area	
			Imperial	Metric
E182	ST-5	4	13.160 SF	1.223 m ²

Abbreviations
 FE - Finished Edge QME - Quirk Mitre Edge

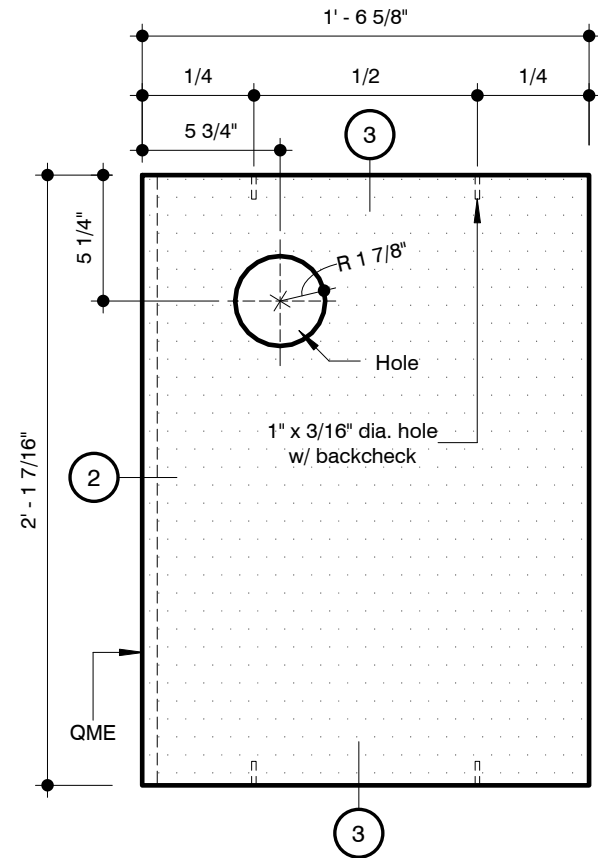

Stone Project Example

6250 Westpark Suite 218 Houston Texas 77057

Date: 02/25/09

Material: Tan Brown Granite

Finish: Polished

Thickness: 2cm

Ticket Number: **TE26**

Mark	Stone Type	Quantity	Area	
			Imperial	Metric
E189	ST-5	4	14.066 SF	1.307 m ²

Abbreviations
 FE - Finished Edge QME - Quirk Mitre Edge

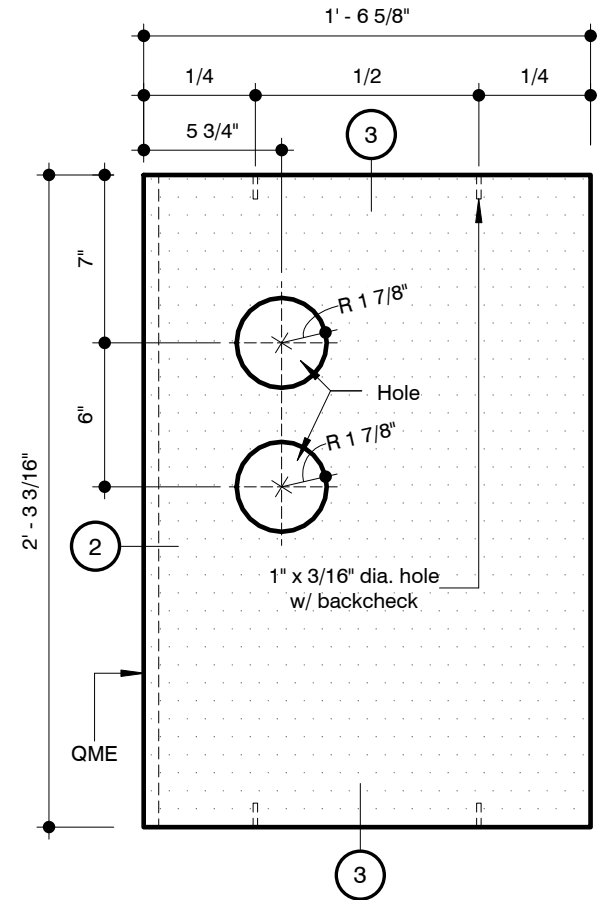

Stone Project Example

6250 Westpark Suite 218 Houston Texas 77057

Date: 02/25/09	Material: Tan Brown Granite	Finish: Polished	Thickness: 2cm	Ticket Number: TE27
----------------	-----------------------------	------------------	----------------	----------------------------

Mark	Stone Type	Quantity	Area	
			Imperial	Metric
E168	ST-5	1	4.282 SF	0.398 m ²

Abbreviations
 FE - Finished Edge QME - Quirk Mitre Edge

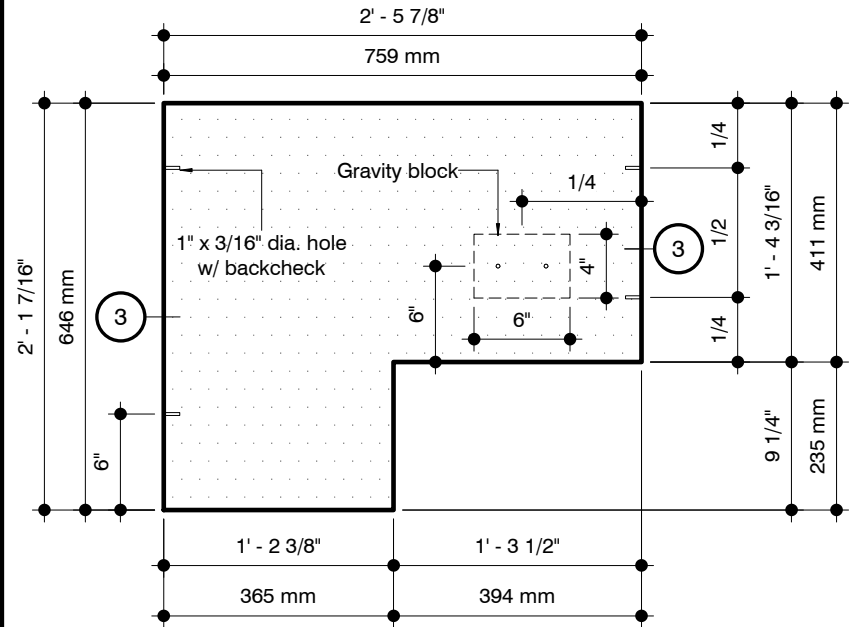

Stone Project Example

6250 Westpark Suite 218 Houston Texas 77057

Date: 02/25/09	Material: Tan Brown Granite	Finish: Polished	Thickness: 2cm	Ticket Number: TE28
----------------	-----------------------------	------------------	----------------	----------------------------

Mark	Stone Type	Quantity	Area	
			Imperial	Metric
E165	ST-5	1	4.282 SF	0.398 m ²

Abbreviations
 FE - Finished Edge QME - Quirk Mitre Edge

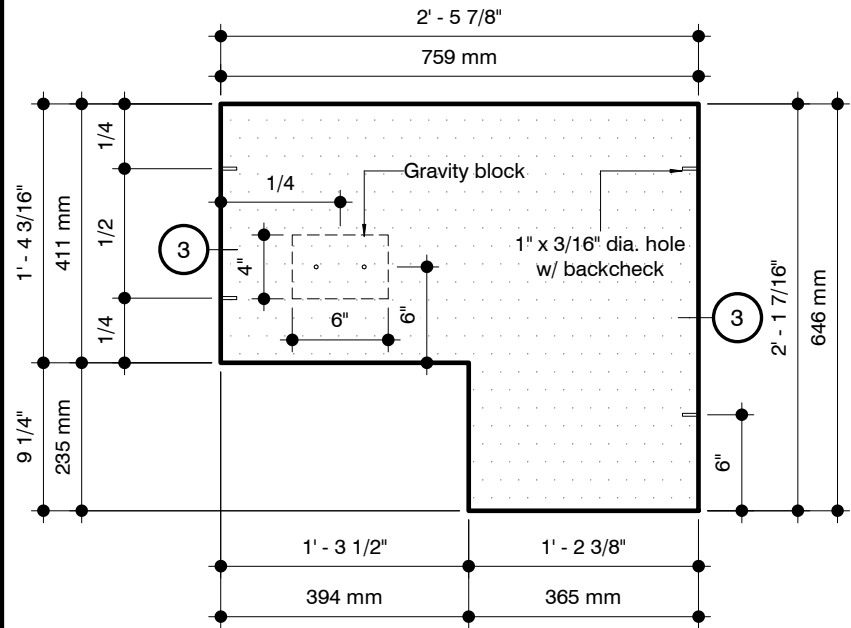

Stone Project Example

6250 Westpark Suite 218 Houston Texas 77057

Date: 02/25/09

Material: Tan Brown Granite

Finish: Polished

Thickness: 2cm

Ticket Number: **TE29**

Mark	Stone Type	A		B		Quantity	Area	
		Imperial	Metric	Imperial	Metric		Imperial	Metric
F7	ST-6	1' - 11 7/8"	606 mm	6 5/8"	168 mm	7	7.551 SF	0.702 m ²
F8	ST-6	2' - 0 11/16"	626 mm	6 5/8"	168 mm	1	1.114 SF	0.104 m ²
F10	ST-6	1' - 11 7/8"	606 mm	6 5/8"	168 mm	7	7.551 SF	0.702 m ²
F13	ST-6	1' - 10 7/8"	581 mm	6 5/8"	168 mm	1	1.034 SF	0.096 m ²
F17	ST-6	1' - 11 11/16"	602 mm	6 5/8"	168 mm	5	5.351 SF	0.497 m ²
F20	ST-6	2' - 0 7/8"	632 mm	6 5/8"	168 mm	7	7.867 SF	0.731 m ²
F21	ST-6	1' - 3"	381 mm	6 5/8"	168 mm	1	0.678 SF	0.063 m ²
F25	ST-6	4' - 5 5/8"	1362 mm	4 1/16"	104 mm	3	4.423 SF	0.411 m ²
F27	ST-6	5' - 0 13/16"	1544 mm	8 5/8"	219 mm	1	3.591 SF	0.334 m ²
F29	ST-6	4' - 5 5/8"	1362 mm	6 1/16"	154 mm	3	6.658 SF	0.619 m ²
F30	ST-6	4' - 4 1/8"	1324 mm	8 5/8"	219 mm	2	6.158 SF	0.572 m ²
F36	ST-6	2' - 9 1/2"	850 mm	6 5/8"	168 mm	2	3.025 SF	0.281 m ²
F37	ST-6	2' - 8 5/8"	829 mm	6 5/8"	168 mm	2	2.948 SF	0.274 m ²
F41	ST-6	2' - 8 5/8"	829 mm	6 5/8"	168 mm	2	2.948 SF	0.274 m ²
F42	ST-6	2' - 8 9/16"	827 mm	6 5/8"	168 mm	2	2.942 SF	0.273 m ²
F44	ST-6	1' - 11 11/16"	602 mm	6 5/8"	168 mm	4	4.281 SF	0.398 m ²
F45	ST-6	1' - 11 7/8"	606 mm	6 5/8"	168 mm	60	64.723 SF	6.013 m ²
F46	ST-6	1' - 6 7/16"	468 mm	6 5/8"	168 mm	3	2.499 SF	0.232 m ²
F48	ST-6	1' - 6 7/16"	468 mm	6 5/8"	168 mm	3	2.499 SF	0.232 m ²
F50	ST-6	1' - 2 1/4"	361 mm	6 5/8"	168 mm	2	1.286 SF	0.119 m ²
F61	ST-6	1' - 11 13/16"	605 mm	6 5/8"	168 mm	3	3.228 SF	0.300 m ²
F62	ST-6	2' - 0 9/16"	624 mm	6 5/8"	168 mm	1	1.110 SF	0.103 m ²
F63	ST-6	2' - 0 5/8"	625 mm	6 5/8"	168 mm	1	1.113 SF	0.103 m ²
F64	ST-6	2' - 7 13/16"	808 mm	6 5/8"	168 mm	1	1.437 SF	0.134 m ²
F69	ST-6	1' - 11 3/4"	603 mm	6 5/8"	168 mm	1	1.073 SF	0.100 m ²
F72	ST-6	1' - 10 5/8"	575 mm	6 5/8"	168 mm	1	1.022 SF	0.095 m ²
F76	ST-6	1' - 11 9/16"	598 mm	6 5/8"	168 mm	1	1.064 SF	0.099 m ²
F77	ST-6	1' - 8 13/16"	529 mm	6 5/8"	168 mm	1	0.940 SF	0.087 m ²
F83	ST-6	1' - 11 13/16"	605 mm	6 5/8"	168 mm	1	1.076 SF	0.100 m ²
F87	ST-6	1' - 9 3/4"	552 mm	6 5/8"	168 mm	1	0.982 SF	0.091 m ²
F89	ST-6	11 7/16"	291 mm	6 5/8"	168 mm	1	0.517 SF	0.048 m ²
F92	ST-6	1' - 11 13/16"	605 mm	4 7/8"	124 mm	3	2.360 SF	0.219 m ²
F93	ST-6	1' - 11 7/8"	606 mm	4 7/8"	124 mm	15	11.829 SF	1.099 m ²
F96	ST-6	1' - 6 3/8"	467 mm	4 7/8"	124 mm	4	2.428 SF	0.226 m ²
Grand total						153	169.304 SF	15.729 m ²

Abbreviations
FE - Finished Edge QME - Quirk Mitre Edge

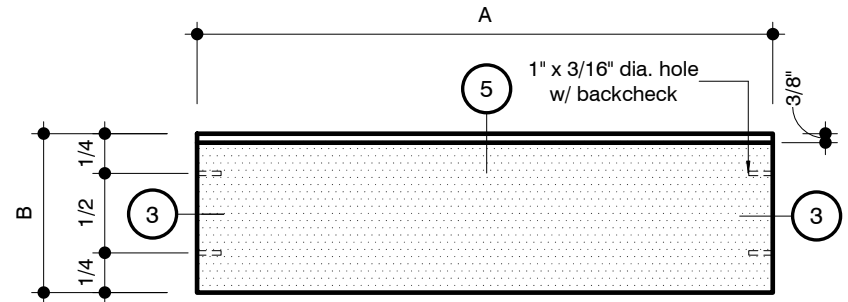

Stone Project Example

6250 Westpark Suite 218 Houston Texas 77057

Date: 02/15/09

Material: Rajah Black Granite

Finish: Polished

Thickness: 2cm

Ticket Number: **TF1**

Mark	Stone Type	A		B		Quantity	Area	
		Imperial	Metric	Imperial	Metric		Imperial	Metric
F103	ST-6	1' - 6 7/16"	468 mm	4 7/8"	124 mm	4	2.436 SF	0.226 m ²
F113	ST-6	1' - 1 15/16"	353 mm	4 7/8"	124 mm	2	0.919 SF	0.085 m ²
F115	ST-6	1' - 8 1/8"	511 mm	4 7/8"	124 mm	1	0.665 SF	0.062 m ²
F135	ST-6	2' - 5 7/8"	759 mm	6 5/8"	168 mm	2	2.700 SF	0.251 m ²
F137	ST-6	2' - 0 7/8"	632 mm	8 5/8"	219 mm	1	1.469 SF	0.137 m ²
F142	ST-6	2' - 9 1/2"	850 mm	4 7/8"	124 mm	2	2.211 SF	0.205 m ²
F143	ST-6	2' - 8 5/8"	829 mm	4 7/8"	124 mm	2	2.155 SF	0.200 m ²
F147	ST-6	1' - 3 7/16"	392 mm	6 5/8"	168 mm	2	1.395 SF	0.130 m ²
F148	ST-6	2' - 1 7/16"	646 mm	6 5/8"	168 mm	1	1.149 SF	0.107 m ²
F150	ST-6	1' - 1 13/16"	350 mm	8 5/8"	219 mm	1	0.815 SF	0.076 m ²
F151	ST-6	10 11/16"	271 mm	8 5/8"	219 mm	1	0.630 SF	0.059 m ²
F152	ST-6	1' - 3 7/16"	392 mm	6 5/8"	168 mm	1	0.697 SF	0.065 m ²
F153	ST-6	4' - 5 5/8"	1362 mm	4 3/4"	121 mm	1	1.728 SF	0.160 m ²
F154	ST-6	4' - 5 5/8"	1362 mm	6 3/4"	172 mm	1	2.472 SF	0.230 m ²
F161	ST-6	2' - 0"	610 mm	4 7/8"	124 mm	6	4.756 SF	0.442 m ²
F162	ST-6	2' - 0"	610 mm	6 5/8"	168 mm	6	6.506 SF	0.604 m ²
Grand total						34	32.704 SF	3.038 m ²

Abbreviations
 FE - Finished Edge QME - Quirk Mitre Edge

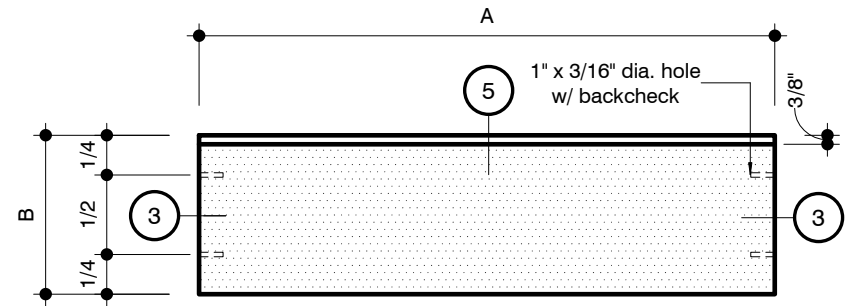

Stone Project Example

6250 Westpark Suite 218 Houston Texas 77057

Date: 02/19/09

Material: Rajah Black Granite

Finish: Polished

Thickness: 2cm

Ticket Number: **TF2**

Mark	Stone Type	A		B		Quantity	Area	
		Imperial	Metric	Imperial	Metric		Imperial	Metric
F6	ST-6	9 3/8"	238 mm	8 5/8"	219 mm	1	0.554 SF	0.051 m ²
F12	ST-6	5 5/8"	143 mm	6 5/8"	168 mm	2	0.508 SF	0.047 m ²
F15	ST-6	7 5/8"	194 mm	6 5/8"	168 mm	1	0.345 SF	0.032 m ²
F23	ST-6	6 9/16"	166 mm	6 5/8"	168 mm	1	0.295 SF	0.027 m ²
F31	ST-6	9 3/4"	248 mm	8 5/8"	219 mm	1	0.576 SF	0.054 m ²
F32	ST-6	9 3/8"	238 mm	7 15/16"	202 mm	5	2.549 SF	0.237 m ²
F39	ST-6	2' - 8 7/16"	824 mm	6 5/8"	168 mm	1	1.466 SF	0.136 m ²
F40	ST-6	2' - 8 7/16"	824 mm	6 5/8"	168 mm	1	1.466 SF	0.136 m ²
F43	ST-6	3' - 3 1/2"	1003 mm	6 5/8"	168 mm	1	1.785 SF	0.166 m ²
F49	ST-6	1' - 6 5/8"	473 mm	6 5/8"	168 mm	7	5.891 SF	0.547 m ²
F53	ST-6	1' - 11 5/8"	600 mm	6 5/8"	168 mm	1	1.067 SF	0.099 m ²
F60	ST-6	1' - 6 3/16"	462 mm	6 5/8"	168 mm	1	0.822 SF	0.076 m ²
F68	ST-6	2' - 0 3/16"	614 mm	6 5/8"	168 mm	1	1.093 SF	0.102 m ²
F71	ST-6	2' - 11"	889 mm	6 5/8"	168 mm	1	1.581 SF	0.147 m ²
F74	ST-6	1' - 11 5/8"	600 mm	6 5/8"	168 mm	1	1.067 SF	0.099 m ²
F75	ST-6	1' - 8 13/16"	529 mm	6 5/8"	168 mm	1	0.940 SF	0.087 m ²
F78	ST-6	1' - 4 1/8"	410 mm	6 5/8"	168 mm	1	0.729 SF	0.068 m ²
F81	ST-6	1' - 4 5/8"	422 mm	6 5/8"	168 mm	1	0.751 SF	0.070 m ²
F91	ST-6	2' - 0 5/8"	625 mm	4 7/8"	124 mm	1	0.813 SF	0.076 m ²
F101	ST-6	1' - 6 5/8"	473 mm	4 7/8"	124 mm	7	4.306 SF	0.400 m ²
F106	ST-6	10 5/8"	270 mm	4 7/8"	124 mm	1	0.351 SF	0.033 m ²
F107	ST-6	11 5/8"	295 mm	4 7/8"	124 mm	1	0.384 SF	0.036 m ²
F110	ST-6	11"	279 mm	4 7/8"	124 mm	1	0.363 SF	0.034 m ²
F119	ST-6	1' - 8 1/8"	511 mm	4 7/8"	124 mm	1	0.665 SF	0.062 m ²
F121	ST-6	1' - 8 1/8"	511 mm	4 7/8"	124 mm	1	0.665 SF	0.062 m ²
F124	ST-6	9 3/4"	248 mm	4 7/8"	124 mm	4	1.288 SF	0.120 m ²
F126	ST-6	9 3/4"	248 mm	4 7/8"	124 mm	3	0.966 SF	0.090 m ²
F129	ST-6	2' - 5 1/16"	738 mm	6 5/8"	168 mm	1	1.313 SF	0.122 m ²
F146	ST-6	1' - 10 5/8"	575 mm	6 5/8"	168 mm	1	1.022 SF	0.095 m ²
F149	ST-6	1' - 1 5/8"	346 mm	6 5/8"	168 mm	1	0.616 SF	0.057 m ²
F164	ST-6	1' - 0 5/8"	321 mm	4 7/8"	124 mm	1	0.417 SF	0.039 m ²
F166	ST-6	2' - 8 7/16"	824 mm	4 7/8"	124 mm	1	1.071 SF	0.100 m ²
Grand total						54	37.725 SF	3.505 m ²

Abbreviations
FE - Finished Edge QME - Quirk Mitre Edge

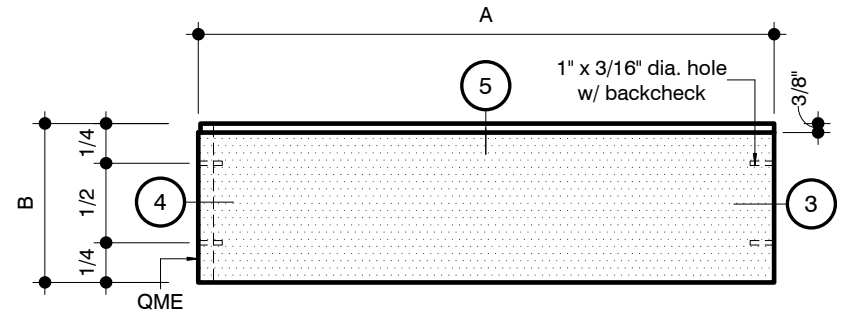

Stone Project Example

6250 Westpark Suite 218 Houston Texas 77057

Date: 02/15/09

Material: Rajah Black Granite

Finish: Polished

Thickness: 2cm

Ticket Number: **TF3**

Mark	Stone Type	A		B		Quantity	Area	
		Imperial	Metric	Imperial	Metric		Imperial	Metric
F11	ST-6	5 5/8"	143 mm	6 5/8"	168 mm	1	0.254 SF	0.024 m ²
F16	ST-6	5 5/8"	143 mm	6 5/8"	168 mm	1	0.254 SF	0.024 m ²
F19	ST-6	7 11/16"	195 mm	6 5/8"	168 mm	1	0.347 SF	0.032 m ²
F24	ST-6	6 1/2"	165 mm	6 5/8"	168 mm	1	0.293 SF	0.027 m ²
F26	ST-6	1' - 6 9/16"	471 mm	8 5/8"	219 mm	1	1.095 SF	0.102 m ²
F33	ST-6	9 3/8"	238 mm	8 5/8"	219 mm	5	2.769 SF	0.257 m ²
F34	ST-6	10 5/16"	261 mm	8 5/8"	219 mm	1	0.608 SF	0.056 m ²
F35	ST-6	1' - 10 5/8"	575 mm	6 5/8"	168 mm	1	1.022 SF	0.095 m ²
F38	ST-6	2' - 8 7/16"	824 mm	6 5/8"	168 mm	1	1.466 SF	0.136 m ²
F47	ST-6	1' - 6 5/8"	473 mm	6 5/8"	168 mm	7	5.891 SF	0.547 m ²
F51	ST-6	1' - 6 3/16"	462 mm	6 5/8"	168 mm	1	0.822 SF	0.076 m ²
F52	ST-6	1' - 11 5/8"	600 mm	6 5/8"	168 mm	1	1.067 SF	0.099 m ²
F54	ST-6	9 3/4"	248 mm	6 5/8"	168 mm	7	3.084 SF	0.286 m ²
F55	ST-6	9 3/4"	248 mm	6 5/8"	168 mm	7	3.084 SF	0.286 m ²
F58	ST-6	2' - 8 7/16"	824 mm	6 5/8"	168 mm	1	1.466 SF	0.136 m ²
F59	ST-6	3' - 3 1/2"	1003 mm	6 5/8"	168 mm	1	1.785 SF	0.166 m ²
F67	ST-6	2' - 11"	889 mm	6 5/8"	168 mm	1	1.581 SF	0.147 m ²
F70	ST-6	2' - 0 1/8"	613 mm	6 5/8"	168 mm	1	1.090 SF	0.101 m ²
F73	ST-6	1' - 11 5/8"	600 mm	6 5/8"	168 mm	1	1.067 SF	0.099 m ²
F79	ST-6	1' - 4 5/8"	422 mm	6 5/8"	168 mm	1	0.751 SF	0.070 m ²
F90	ST-6	2' - 0 3/16"	614 mm	6 5/8"	168 mm	1	1.093 SF	0.102 m ²
F97	ST-6	2' - 0 5/8"	625 mm	4 7/8"	124 mm	1	0.813 SF	0.076 m ²
F100	ST-6	1' - 0 5/8"	321 mm	4 7/8"	124 mm	1	0.417 SF	0.039 m ²
F102	ST-6	1' - 6 5/8"	473 mm	4 7/8"	124 mm	7	4.306 SF	0.400 m ²
F104	ST-6	11"	279 mm	4 7/8"	124 mm	1	0.363 SF	0.034 m ²
F105	ST-6	10 5/8"	270 mm	4 7/8"	124 mm	1	0.351 SF	0.033 m ²
F111	ST-6	11 5/8"	295 mm	4 7/8"	124 mm	1	0.384 SF	0.036 m ²
F114	ST-6	1' - 8 1/8"	511 mm	4 7/8"	124 mm	1	0.665 SF	0.062 m ²
F116	ST-6	1' - 8 1/8"	511 mm	4 7/8"	124 mm	1	0.665 SF	0.062 m ²
F117	ST-6	2' - 0 3/4"	628 mm	4 7/8"	124 mm	1	0.817 SF	0.076 m ²
F118	ST-6	2' - 10 1/4"	869 mm	4 7/8"	124 mm	1	1.130 SF	0.105 m ²
F120	ST-6	1' - 8 1/8"	511 mm	4 7/8"	124 mm	1	0.665 SF	0.062 m ²
F125	ST-6	9 3/4"	248 mm	4 7/8"	124 mm	4	1.288 SF	0.120 m ²
F127	ST-6	9 3/4"	248 mm	4 7/8"	124 mm	3	0.966 SF	0.090 m ²
F128	ST-6	2' - 5 1/16"	738 mm	6 5/8"	168 mm	1	1.313 SF	0.122 m ²
F136	ST-6	1' - 0 9/16"	318 mm	6 5/8"	168 mm	1	0.567 SF	0.053 m ²
F144	ST-6	2' - 8 7/16"	824 mm	4 7/8"	124 mm	1	1.071 SF	0.100 m ²
Grand total						70	46.669 SF	4.336 m ²

Abbreviations
FE - Finished Edge QME - Quirk Mitre Edge

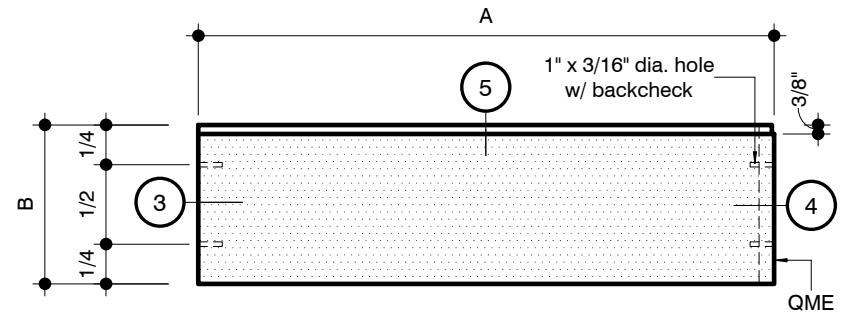

Stone Project Example

6250 Westpark Suite 218 Houston Texas 77057

Date: 02/15/09

Material: Rajah Black Granite

Finish: Polished

Thickness: 2cm

Ticket Number: **TF4**

Mark	Stone Type	A		B		Quantity	Area	
		Imperial	Metric	Imperial	Metric		Imperial	Metric
F9	ST-6	11 1/2"	292 mm	6 5/8"	168 mm	2	1.039 SF	0.097 m ²
F28	ST-6	1' - 5 1/2"	445 mm	8 5/8"	219 mm	3	3.101 SF	0.288 m ²
F56	ST-6	6 3/4"	171 mm	6 5/8"	168 mm	2	0.610 SF	0.057 m ²
F82	ST-6	1' - 4 1/2"	419 mm	6 5/8"	168 mm	1	0.746 SF	0.069 m ²
F140	ST-6	7 5/8"	194 mm	6 5/8"	168 mm	2	0.689 SF	0.064 m ²
F141	ST-6	7 3/4"	197 mm	6 5/8"	168 mm	2	0.700 SF	0.065 m ²
F145	ST-6	8 3/4"	222 mm	6 5/8"	168 mm	2	0.791 SF	0.073 m ²
F155	ST-6	1' - 5 1/2"	445 mm	7 15/16"	202 mm	3	2.858 SF	0.265 m ²
F158	ST-6	7 3/4"	197 mm	4 7/8"	124 mm	2	0.512 SF	0.048 m ²
Grand total						19	11.046 SF	1.026 m ²

Abbreviations
 FE - Finished Edge QME - Quirk Mitre Edge

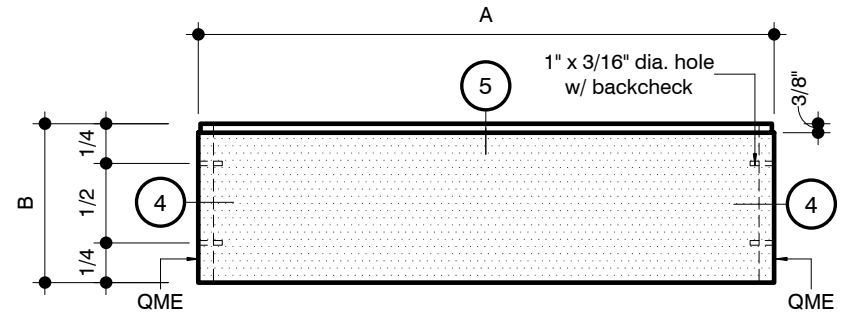

Stone Project Example

6250 Westpark Suite 218 Houston Texas 77057

Date: 02/15/09

Material: Rajah Black Granite

Finish: Polished

Thickness: 2cm

Ticket Number: **TF5**

Mark	Stone Type	A		B		Quantity	Area	
		Imperial	Metric	Imperial	Metric		Imperial	Metric
F2	ST-6	2' - 4 3/16"	716 mm	6 5/8"	168 mm	1	1.274 SF	0.118 m ²
F4	ST-6	2' - 1 1/16"	636 mm	6 5/8"	168 mm	1	1.131 SF	0.105 m ²
F14	ST-6	7 5/8"	194 mm	6 5/8"	168 mm	1	0.345 SF	0.032 m ²
F18	ST-6	1' - 11 11/16"	602 mm	6 5/8"	168 mm	1	1.070 SF	0.099 m ²
F22	ST-6	1' - 7 1/2"	495 mm	6 5/8"	168 mm	1	0.880 SF	0.082 m ²
F66	ST-6	2' - 4 1/4"	718 mm	6 5/8"	168 mm	1	1.276 SF	0.119 m ²
F84	ST-6	8 1/4"	210 mm	6 5/8"	168 mm	1	0.373 SF	0.035 m ²
F88	ST-6	6 1/8"	155 mm	6 5/8"	168 mm	1	0.276 SF	0.026 m ²
F95	ST-6	9 15/16"	252 mm	4 7/8"	124 mm	1	0.328 SF	0.030 m ²
F108	ST-6	1' - 4 7/8"	429 mm	4 7/8"	124 mm	1	0.557 SF	0.052 m ²
F130	ST-6	11 3/16"	284 mm	6 5/8"	168 mm	1	0.505 SF	0.047 m ²
F163	ST-6	1' - 6 3/8"	467 mm	6 5/8"	168 mm	1	0.830 SF	0.077 m ²
Grand total						12	8.845 SF	0.822 m ²

Abbreviations
FE - Finished Edge QME - Quirk Mitre Edge

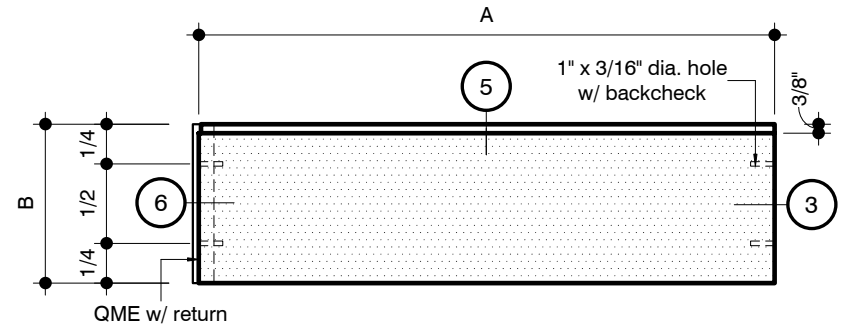

Stone Project Example

6250 Westpark Suite 218 Houston Texas 77057

Date: 02/19/09

Material: Rajah Black Granite

Finish: Polished

Thickness: 2cm

Ticket Number: **TF6**

Mark	Stone Type	A		B		Quantity	Area	
		Imperial	Metric	Imperial	Metric		Imperial	Metric
F1	ST-6	2' - 1 1/16"	636 mm	6 5/8"	168 mm	1	1.131 SF	0.105 m ²
F3	ST-6	2' - 4 3/16"	716 mm	6 5/8"	168 mm	1	1.274 SF	0.118 m ²
F5	ST-6	1' - 0 7/16"	315 mm	6 5/8"	168 mm	1	0.561 SF	0.052 m ²
F65	ST-6	2' - 3 3/8"	695 mm	6 5/8"	168 mm	1	1.237 SF	0.115 m ²
F86	ST-6	1' - 11 5/8"	600 mm	6 5/8"	168 mm	2	2.135 SF	0.198 m ²
F94	ST-6	9 15/16"	252 mm	4 7/8"	124 mm	1	0.328 SF	0.030 m ²
F99	ST-6	1' - 3 7/8"	403 mm	4 7/8"	124 mm	1	0.524 SF	0.049 m ²
F109	ST-6	1' - 4 7/8"	429 mm	4 7/8"	124 mm	1	0.557 SF	0.052 m ²
F122	ST-6	1' - 6 3/8"	467 mm	6 5/8"	168 mm	1	0.830 SF	0.077 m ²
F131	ST-6	8 1/4"	210 mm	6 5/8"	168 mm	1	0.373 SF	0.035 m ²
Grand total						11	8.950 SF	0.831 m ²

Abbreviations
 FE - Finished Edge QME - Quirk Mitre Edge

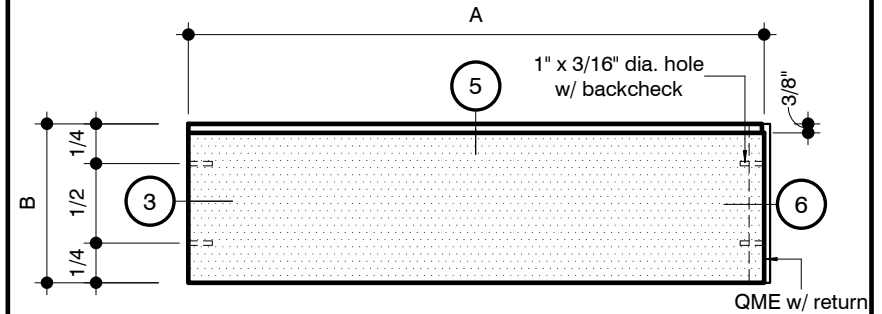

Stone Project Example

6250 Westpark Suite 218 Houston Texas 77057

Date: 02/19/09

Material: Rajah Black Granite

Finish: Polished

Thickness: 2cm

Ticket Number: **TF7**

Mark	Stone Type	A		B		Quantity	Area	
		Imperial	Metric	Imperial	Metric		Imperial	Metric
F80	ST-6	3 5/8"	92 mm	6 5/8"	168 mm	2	0.328 SF	0.030 m ²
F156	ST-6	2 5/8"	67 mm	6 5/8"	168 mm	1	0.119 SF	0.011 m ²
F159	ST-6	2 5/8"	67 mm	4 7/8"	124 mm	1	0.087 SF	0.008 m ²
Grand total						4	0.533 SF	0.050 m ²

Abbreviations
 FE - Finished Edge QME - Quirk Mitre Edge

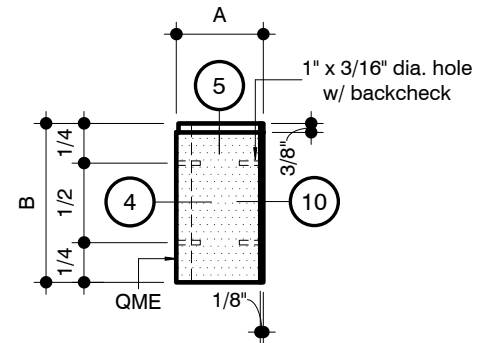

Stone Project Example

6250 Westpark Suite 218 Houston Texas 77057

Date: 02/23/09

Material: Rajah Black Granite

Finish: Polished

Thickness: 2cm

Ticket Number: **TF8**

Mark	Stone Type	A		B		Quantity	Area	
		Imperial	Metric	Imperial	Metric		Imperial	Metric
F57	ST-6	3 5/8"	92 mm	6 5/8"	168 mm	2	0.328 SF	0.030 m ²
F156	ST-6	2 5/8"	67 mm	6 5/8"	168 mm	1	0.119 SF	0.011 m ²
F160	ST-6	2 5/8"	67 mm	4 7/8"	124 mm	1	0.087 SF	0.008 m ²
Grand total						4	0.533 SF	0.050 m ²

Abbreviations
FE - Finished Edge QME - Quirk Mitre Edge

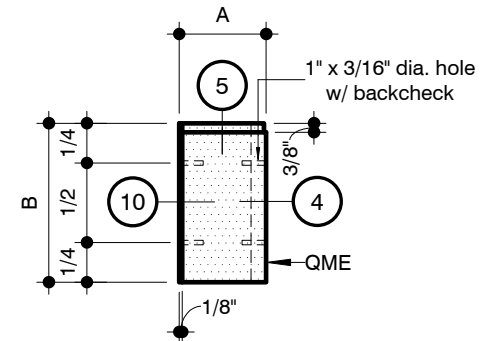

Stone Project Example

6250 Westpark Suite 218 Houston Texas 77057

Date: 02/23/09

Material: Rajah Black Granite

Finish: Polished

Thickness: 2cm

Ticket Number: **TF9**

Mark	Stone Type	A		B		Quantity	Area	
		Imperial	Metric	Imperial	Metric		Imperial	Metric
F134	ST-6	1' - 9 3/16"	538 mm	6 5/8"	168 mm	1	0.956 SF	0.089 m ²
Grand total						1	0.956 SF	0.089 m ²

Abbreviations
 FE - Finished Edge QME - Quirk Mitre Edge

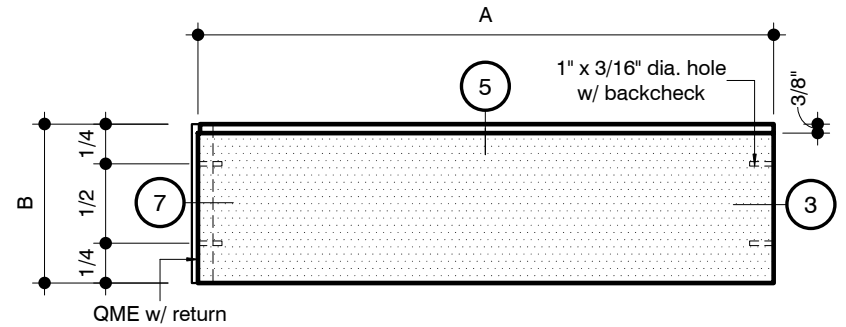

Stone Project Example

6250 Westpark Suite 218 Houston Texas 77057

Date: 02/26/09

Material: Rajah Black Granite

Finish: Polished

Thickness: 2cm

Ticket Number: **TF10**

Mark	Stone Type	A		B		Quantity	Area	
		Imperial	Metric	Imperial	Metric		Imperial	Metric
F133	ST-6	1' - 9 3/16"	538 mm	6 5/8"	168 mm	1	0.956 SF	0.089 m ²
Grand total						1	0.956 SF	0.089 m ²

Abbreviations
 FE - Finished Edge QME - Quirk Mitre Edge

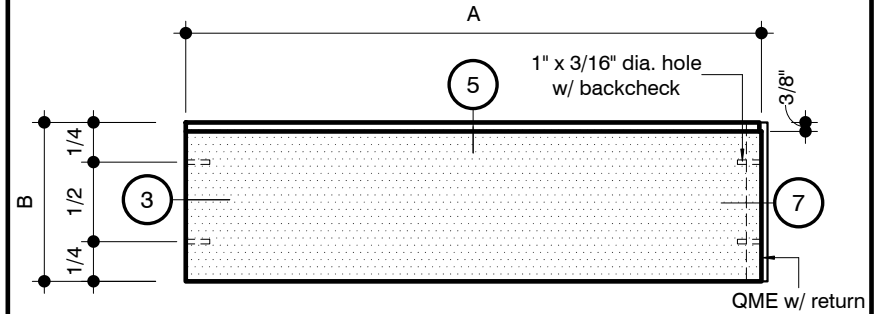

Stone Project Example

6250 Westpark Suite 218 Houston Texas 77057

Date: 02/26/09

Material: Rajah Black Granite

Finish: Polished

Thickness: 2cm

Ticket Number: **TF11**

Mark	Stone Type	A		B		Quantity	Area	
		Imperial	Metric	Imperial	Metric		Imperial	Metric
F132	ST-6	9"	229 mm	6 5/8"	168 mm	1	0.407 SF	0.038 m ²
Grand total						1	0.407 SF	0.038 m ²

Abbreviations
 FE - Finished Edge QME - Quirk Mitre Edge

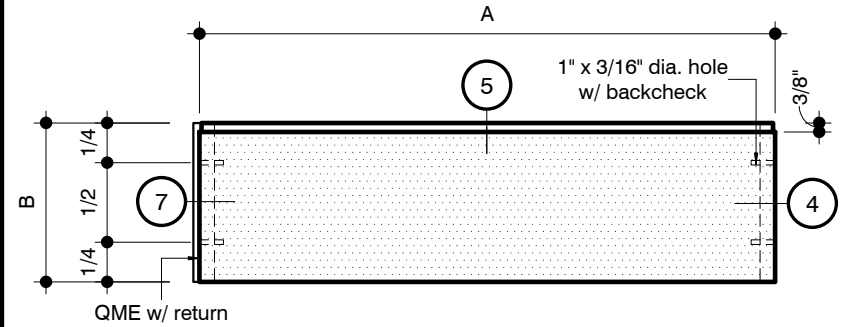

Stone Project Example

6250 Westpark Suite 218 Houston Texas 77057

Date: 02/26/09

Material: Rajah Black Granite

Finish: Polished

Thickness: 2cm

Ticket Number: **TF12**

Mark	Stone Type	A		B		Quantity	Area	
		Imperial	Metric	Imperial	Metric		Imperial	Metric
F165	ST-6	9"	229 mm	6 5/8"	168 mm	1	0.407 SF	0.038 m ²
Grand total						1	0.407 SF	0.038 m ²

Abbreviations
 FE - Finished Edge QME - Quirk Mitre Edge

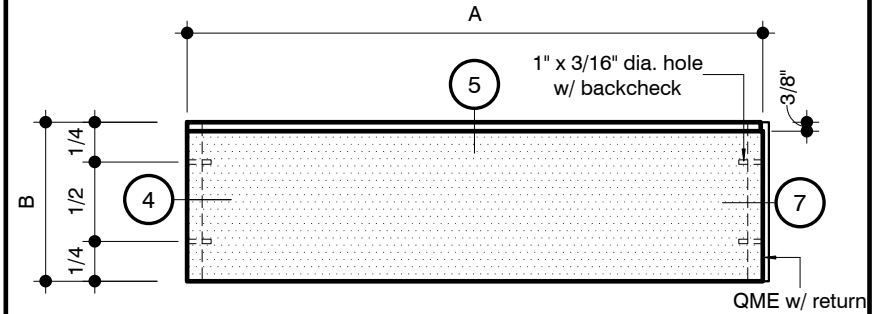

Stone Project Example

6250 Westpark Suite 218 Houston Texas 77057

Date: 02/26/09

Material: Rajah Black Granite

Finish: Polished

Thickness: 2cm

Ticket Number: **TF13**

Mark	Stone Type	A		Quantity	Area	
		Imperial	Metric		Imperial	Metric
G1	ST-7	2' - 0 9/16"	624 mm	4	4.008 SF	0.372 m ²
G2	ST-7	1' - 11 7/8"	606 mm	17	16.559 SF	1.538 m ²
G3	ST-1	2' - 0 5/8"	625 mm	4	4.019 SF	0.373 m ²
G4	ST-7	2' - 0 3/4"	628 mm	3	3.026 SF	0.281 m ²
G5	ST-7	1' - 11 7/8"	606 mm	3	3.793 SF	0.352 m ²
G6	ST-7	2' - 0 3/4"	628 mm	1	1.309 SF	0.122 m ²
Grand total				32	32.715 SF	3.039 m ²

Abbreviations
 FE - Finished Edge QME - Quirk Mitre Edge

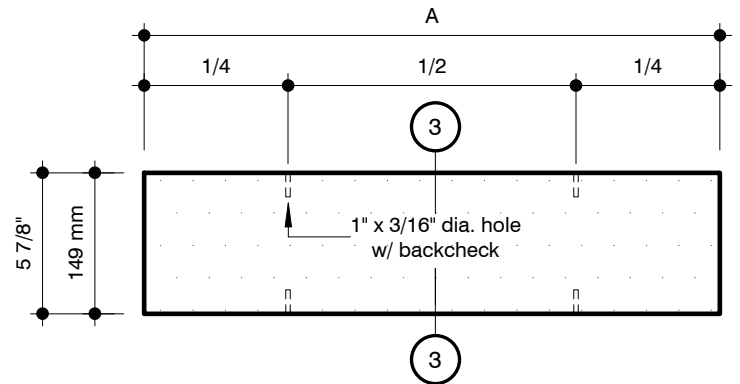

Stone Project Example

6250 Westpark Suite 218 Houston Texas 77057

Date: 02/15/09

Material: Porto Granite

Finish: Sandblasted

Thickness: 2cm

Ticket Number: **TG1**

Mark	Stone Type	A		B		Quantity	Area	
		Imperial	Metric	Imperial	Metric		Imperial	Metric
H1	ST-6	2' - 7 13/16"	808 mm	1' - 7 3/8"	492 mm	1	4.280 SF	0.398 m ²
H2	ST-6	2' - 7 13/16"	808 mm	1' - 7 7/16"	494 mm	2	8.588 SF	0.798 m ²
H3	ST-6	2' - 7 13/16"	808 mm	1' - 7 1/2"	495 mm	1	4.308 SF	0.400 m ²
H4	ST-6	2' - 7 13/16"	808 mm	3' - 1"	940 mm	1	8.174 SF	0.759 m ²
H5	ST-6	2' - 10 1/4"	869 mm	1' - 7 3/8"	492 mm	1	4.605 SF	0.428 m ²
H6	ST-6	2' - 10 1/4"	869 mm	1' - 7 7/16"	494 mm	2	9.239 SF	0.858 m ²
H7	ST-6	2' - 10 1/4"	869 mm	1' - 7 1/2"	495 mm	1	4.634 SF	0.431 m ²
Grand total						9	43.828 SF	4.072 m ²

Abbreviations
 FE - Finished Edge QME - Quirk Mitre Edge

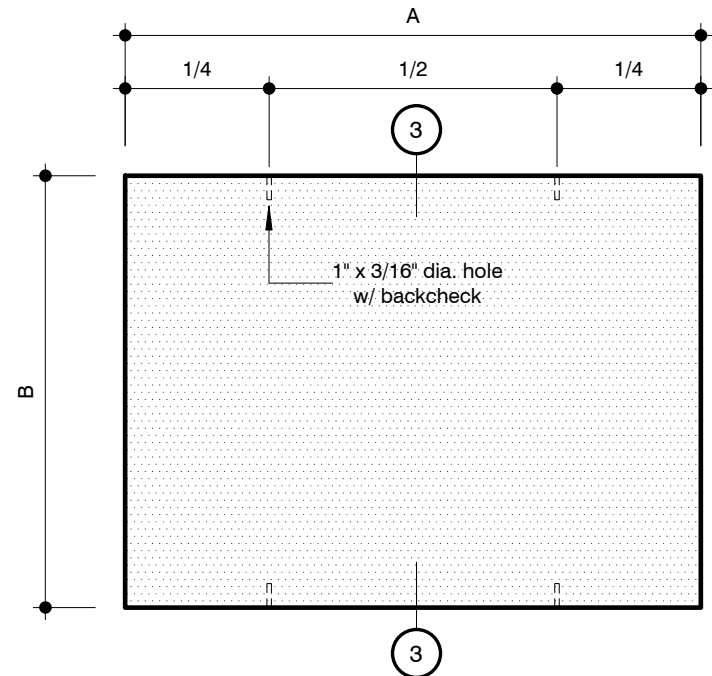

Stone Project Example

6250 Westpark Suite 218 Houston Texas 77057

Date: 02/15/09

Material: Rajah Black Granite

Finish: Polished

Thickness: 2cm

Ticket Number: **TH1**

Mark	Stone Type	A		Quantity	Area	
		Imperial	Metric		Imperial	Metric
J1	ST-8	2' - 7 13/16"	808 mm	4	5.192 SF	0.482 m ²
J2	ST-8	2' - 10 3/16"	868 mm	3	4.181 SF	0.388 m ²
J3	ST-8	2' - 10 3/16"	868 mm	1	1.809 SF	0.168 m ²
Grand total				8	11.182 SF	1.039 m ²

Abbreviations
 FE - Finished Edge QME - Quirk Mitre Edge

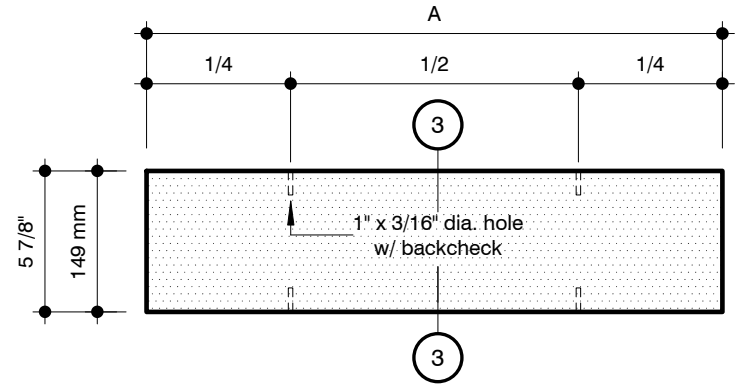

Stone Project Example

6250 Westpark Suite 218 Houston Texas 77057

Date: 02/15/09

Material: Rajah Black Granite

Finish: Sandblasted

Thickness: 2cm

Ticket Number: **TJ1**

Mark	Stone Type	A		B		Quantity	Area	
		Imperial	Metric	Imperial	Metric		Imperial	Metric
K1	ST-2	2' - 0 7/8"	632 mm	11 13/16"	300 mm	1	2.041 SF	0.190 m ²
K2	ST-2	2' - 0 7/8"	632 mm	11 7/8"	302 mm	9	18.462 SF	1.715 m ²
K3	ST-2	2' - 0 7/8"	632 mm	9 5/16"	237 mm	1	1.609 SF	0.149 m ²
K4	ST-2	1' - 11 13/16"	605 mm	11 13/16"	300 mm	1	1.953 SF	0.181 m ²
K5	ST-2	1' - 11 7/8"	606 mm	11 13/16"	300 mm	2	3.917 SF	0.364 m ²
K6	ST-2	7 15/16"	202 mm	11 13/16"	300 mm	1	0.651 SF	0.060 m ²
K7	ST-2	1' - 11 13/16"	605 mm	11 7/8"	302 mm	25	49.093 SF	4.561 m ²
K8	ST-2	1' - 11 7/8"	606 mm	11 7/8"	302 mm	50	98.443 SF	9.146 m ²
K9	ST-2	7 15/16"	202 mm	11 7/8"	302 mm	25	16.364 SF	1.520 m ²
K10	ST-2	7 15/16"	202 mm	2 1/8"	54 mm	1	0.117 SF	0.011 m ²
K11	ST-2	1' - 11 7/8"	606 mm	3 1/8"	79 mm	2	1.036 SF	0.096 m ²
K12	ST-2	1' - 11 13/16"	605 mm	3 1/8"	79 mm	1	0.517 SF	0.048 m ²
K13	ST-2	1' - 11 13/16"	605 mm	1' - 0 9/16"	319 mm	1	2.077 SF	0.193 m ²
K14	ST-2	1' - 11 7/8"	606 mm	1' - 0 9/16"	319 mm	2	4.166 SF	0.387 m ²
K15	ST-2	7 15/16"	202 mm	11 9/16"	294 mm	1	0.637 SF	0.059 m ²
K16	ST-2	1' - 6 3/8"	467 mm	11 13/16"	300 mm	2	3.015 SF	0.280 m ²
K18	ST-2	1' - 6 3/8"	467 mm	11 7/8"	302 mm	18	27.275 SF	2.534 m ²
K20	ST-2	1' - 6 3/8"	467 mm	9 5/16"	237 mm	2	2.377 SF	0.221 m ²
K22	ST-2	1' - 6 7/8"	479 mm	11 13/16"	300 mm	4	6.193 SF	0.575 m ²
K23	ST-2	1' - 6 7/8"	479 mm	11 7/8"	302 mm	36	56.035 SF	5.206 m ²
K24	ST-2	1' - 6 7/8"	479 mm	9 5/16"	237 mm	4	4.883 SF	0.454 m ²
K25	ST-2	2' - 0"	610 mm	11 13/16"	300 mm	3	5.906 SF	0.549 m ²
K26	ST-2	2' - 0"	610 mm	11 7/8"	302 mm	27	53.438 SF	4.965 m ²
K27	ST-2	2' - 0"	610 mm	9 5/16"	237 mm	3	4.656 SF	0.433 m ²
K28	ST-2	1' - 6 1/4"	464 mm	11 13/16"	300 mm	4	5.988 SF	0.556 m ²
K29	ST-2	1' - 6 1/4"	464 mm	11 7/8"	302 mm	36	54.180 SF	5.033 m ²
K30	ST-2	1' - 6 1/4"	464 mm	9 5/16"	237 mm	4	4.721 SF	0.439 m ²
K31	ST-2	1' - 6 7/16"	468 mm	11 13/16"	300 mm	2	3.025 SF	0.281 m ²
K32	ST-2	1' - 6 7/16"	468 mm	11 7/8"	302 mm	18	27.368 SF	2.543 m ²
K33	ST-2	1' - 6 7/16"	468 mm	9 5/16"	237 mm	2	2.385 SF	0.222 m ²
K34	ST-2	1' - 6 7/8"	479 mm	3 7/8"	98 mm	72	36.570 SF	3.397 m ²
K35	ST-2	1' - 8 13/16"	529 mm	3 7/8"	98 mm	72	40.324 SF	3.746 m ²
Grand total						432	539.422 SF	50.114 m ²

Abbreviations
FE - Finished Edge QME - Quirk Mitre Edge

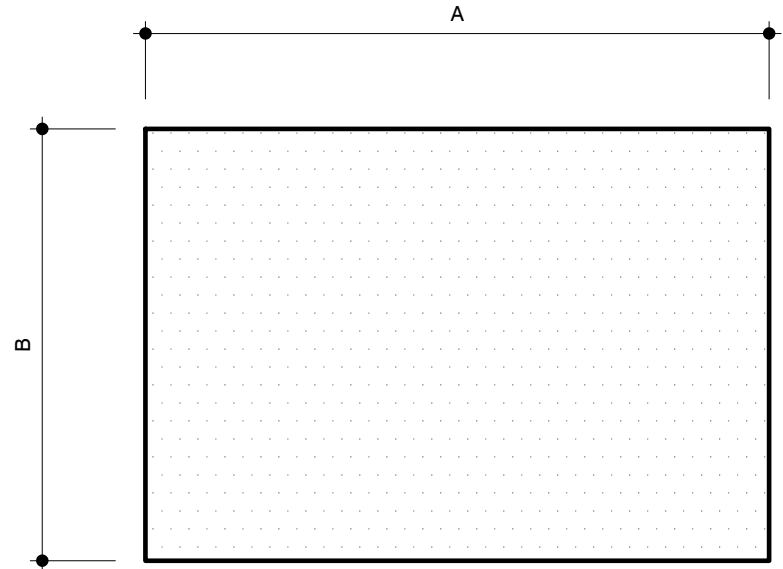

Stone Project Example

6250 Westpark Suite 218 Houston Texas 77057

Date: 02/15/09

Material: Tan Brown Granite

Finish: Polished

Thickness: 1/2"

Ticket Number: **TK1**

Mark	Stone Type	A		B		Quantity	Area	
		Imperial	Metric	Imperial	Metric		Imperial	Metric
L1	ST-1	1' - 11 13/16"	605 mm	1' - 11 13/16"	605 mm	2	7.875 SF	0.732 m ²
L2	ST-1	1' - 11 7/8"	606 mm	1' - 11 13/16"	605 mm	6	23.688 SF	2.201 m ²
L3	ST-1	1' - 11 13/16"	605 mm	1' - 11 7/8"	606 mm	6	23.688 SF	2.201 m ²
L4	ST-1	1' - 11 7/8"	606 mm	1' - 11 7/8"	606 mm	30	118.753 SF	11.033 m ²
L5	ST-1	1' - 11 7/8"	606 mm	2' - 2 1/2"	673 mm	4	17.575 SF	1.633 m ²
L6	ST-1	1' - 8 13/16"	529 mm	1' - 11 13/16"	605 mm	8	27.533 SF	2.558 m ²
L7	ST-1	1' - 8 13/16"	529 mm	1' - 11 7/8"	606 mm	24	82.816 SF	7.694 m ²
L8	ST-1	1' - 10 7/8"	581 mm	1' - 11 13/16"	605 mm	2	7.565 SF	0.703 m ²
L9	ST-1	1' - 10 7/8"	581 mm	1' - 11 7/8"	606 mm	6	22.756 SF	2.114 m ²
L10	ST-1	1' - 11 7/8"	606 mm	1' - 8 3/8"	518 mm	3	10.134 SF	0.942 m ²
L11	ST-1	10 7/8"	276 mm	1' - 8 3/8"	518 mm	6	9.232 SF	0.858 m ²
L12	ST-1	1' - 11 13/16"	605 mm	1' - 8 3/8"	518 mm	6	20.216 SF	1.878 m ²
L13	ST-1	1' - 11 13/16"	605 mm	1' - 11 13/16"	605 mm	2	7.875 SF	0.732 m ²
L14	ST-1	1' - 11 13/16"	605 mm	1' - 11 7/8"	606 mm	6	23.688 SF	2.201 m ²
L15	ST-1	10 7/8"	276 mm	1' - 1"	330 mm	2	1.964 SF	0.182 m ²
L16	ST-1	1' - 8 13/16"	529 mm	6 5/16"	160 mm	36	32.845 SF	3.051 m ²
L17	ST-1	1' - 8 13/16"	529 mm	11 7/8"	302 mm	54	92.681 SF	8.610 m ²
L18	ST-1	1' - 8 13/16"	529 mm	4 1/4"	108 mm	18	11.057 SF	1.027 m ²
L19	ST-1	1' - 6 7/8"	479 mm	6 5/16"	160 mm	18	14.894 SF	1.384 m ²
L20	ST-1	1' - 6 7/8"	479 mm	11 7/8"	302 mm	18	28.018 SF	2.603 m ²
L21	ST-1	1' - 6 7/8"	479 mm	11 7/8"	302 mm	9	14.009 SF	1.301 m ²
L22	ST-1	1' - 11 13/16"	605 mm	1' - 9 3/8"	543 mm	2	7.069 SF	0.657 m ²
L23	ST-1	1' - 11 7/8"	606 mm	1' - 9 3/8"	543 mm	1	3.544 SF	0.329 m ²
L24	ST-1	1' - 8 13/16"	529 mm	9 1/4"	235 mm	8	10.695 SF	0.994 m ²
Grand total						277	620.172 SF	57.616 m ²

Abbreviations
FE - Finished Edge QME - Quirk Mitre Edge

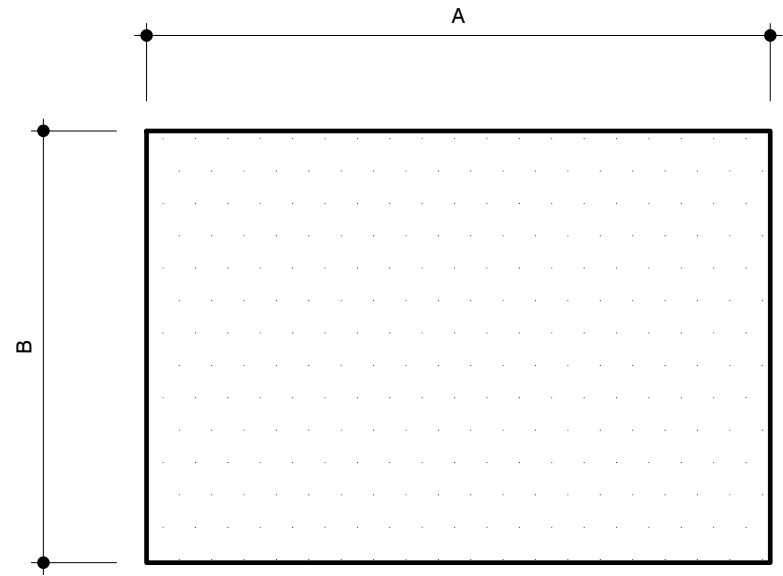

Stone Project Example

6250 Westpark Suite 218 Houston Texas 77057

Date: 02/15/09

Material: Porto Granite

Finish: Polished

Thickness: 1/2"

Ticket Number: **TL1**

Mark	Stone Type	A		B		Quantity	Area	
		Imperial	Metric	Imperial	Metric		Imperial	Metric
M1	ST-3	11 13/16"	300 mm	11 7/8"	302 mm	4	3.896 SF	0.362 m ²
M2	ST-3	11 7/8"	302 mm	11 7/8"	302 mm	48	47.005 SF	4.367 m ²
M3	ST-3	11 13/16"	300 mm	9 5/16"	237 mm	2	1.528 SF	0.142 m ²
M4	ST-3	11 7/8"	302 mm	9 5/16"	237 mm	24	18.431 SF	1.712 m ²
M5	ST-3	2' - 11 3/4"	908 mm	6 15/16"	176 mm	1	1.722 SF	0.160 m ²
M6	ST-3	10 3/8"	264 mm	11 7/8"	302 mm	16	13.689 SF	1.272 m ²
M7	ST-3	10 5/16"	262 mm	11 7/8"	302 mm	16	13.607 SF	1.264 m ²
M8	ST-3	10 3/8"	264 mm	9 5/16"	237 mm	8	5.368 SF	0.499 m ²
M9	ST-3	10 5/16"	262 mm	9 5/16"	237 mm	8	5.335 SF	0.496 m ²
M10	ST-3	3' - 5 3/4"	1060 mm	2 9/16"	65 mm	1	0.743 SF	0.069 m ²
M11	ST-3	3' - 5 3/4"	1060 mm	9 1/4"	235 mm	3	8.046 SF	0.747 m ²
M12	ST-3	11 3/8"	289 mm	11 7/8"	302 mm	8	7.504 SF	0.697 m ²
M13	ST-3	11 13/16"	300 mm	9 5/16"	237 mm	2	1.528 SF	0.142 m ²
M14	ST-3	11 3/8"	289 mm	9 5/16"	237 mm	4	2.942 SF	0.273 m ²
M15	ST-3	11 13/16"	300 mm	11 7/8"	302 mm	4	3.896 SF	0.362 m ²
M16	ST-3	1' - 6 7/8"	479 mm	6 5/16"	160 mm	18	14.894 SF	1.384 m ²
M17	ST-3	1' - 6 7/8"	479 mm	11 7/8"	302 mm	27	42.026 SF	3.904 m ²
Grand total						194	192.161 SF	17.852 m ²

Abbreviations
 FE - Finished Edge QME - Quirk Mitre Edge

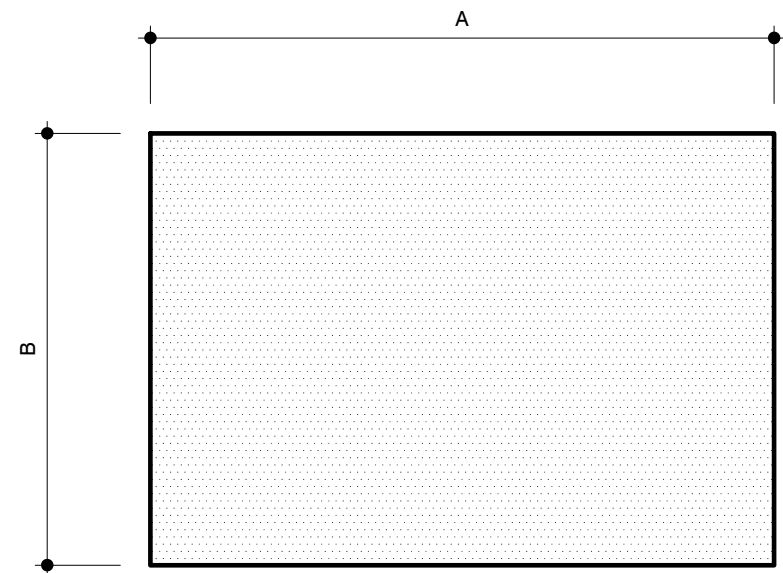

Stone Project Example

6250 Westpark Suite 218 Houston Texas 77057

Date: 02/15/09

Material: Rajah Black Granite

Finish: Polished

Thickness: 1/2"

Ticket Number: **TM1**

Mark	Stone Type	Quantity	Area	
			Imperial	Metric
CT1	ST-9	17	142.274 SF	13.218 m ²

Abbreviations
 FE - Finished Edge QME - Quirk Mitre Edge

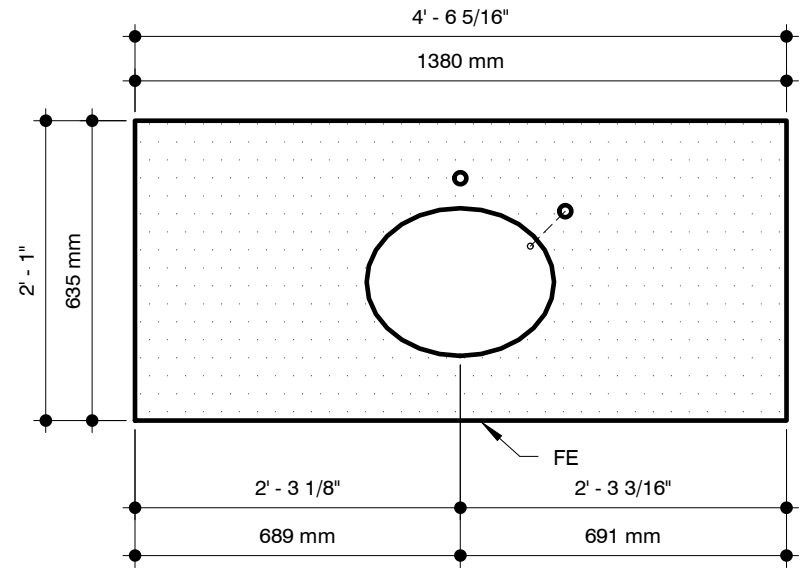

Stone Project Example

6250 Westpark Suite 218 Houston Texas 77057

Date: 02/27/09	Material: Tan Brown Granite	Finish: Polished	Thickness: 2cm	Ticket Number: TT1
----------------	-----------------------------	------------------	----------------	---------------------------

Mark	Stone Type	Quantity	Area	
			Imperial	Metric
CT2	ST-9	17	142.274 SF	13.218 m ²

Abbreviations
 FE - Finished Edge QME - Quirk Mitre Edge

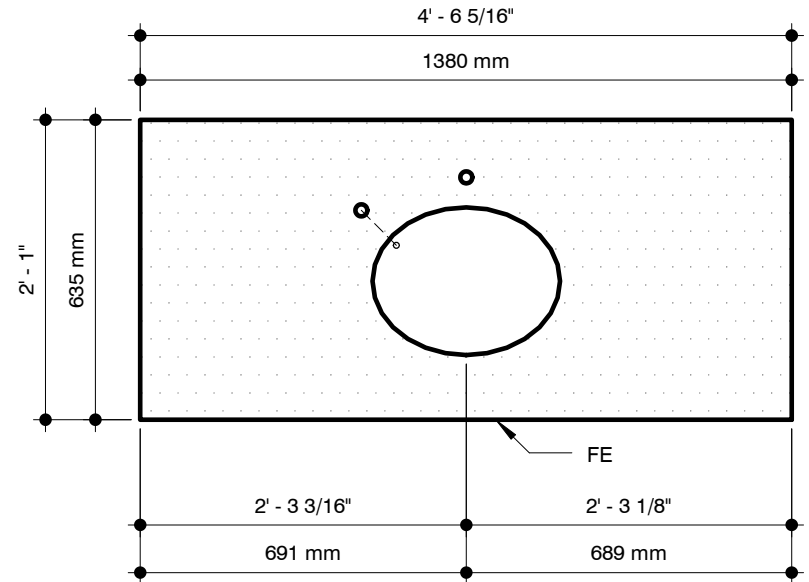

Stone Project Example

6250 Westpark Suite 218 Houston Texas 77057

Date: 02/27/09

Material: Tan Brown Granite

Finish: Polished

Thickness: 2cm

Ticket Number: **TT2**

Mark	Stone Type	Quantity	Area	
			Imperial	Metric
CT9	ST-9	17	175.716 SF	16.325 m ²

Abbreviations
 FE - Finished Edge QME - Quirk Mitre Edge

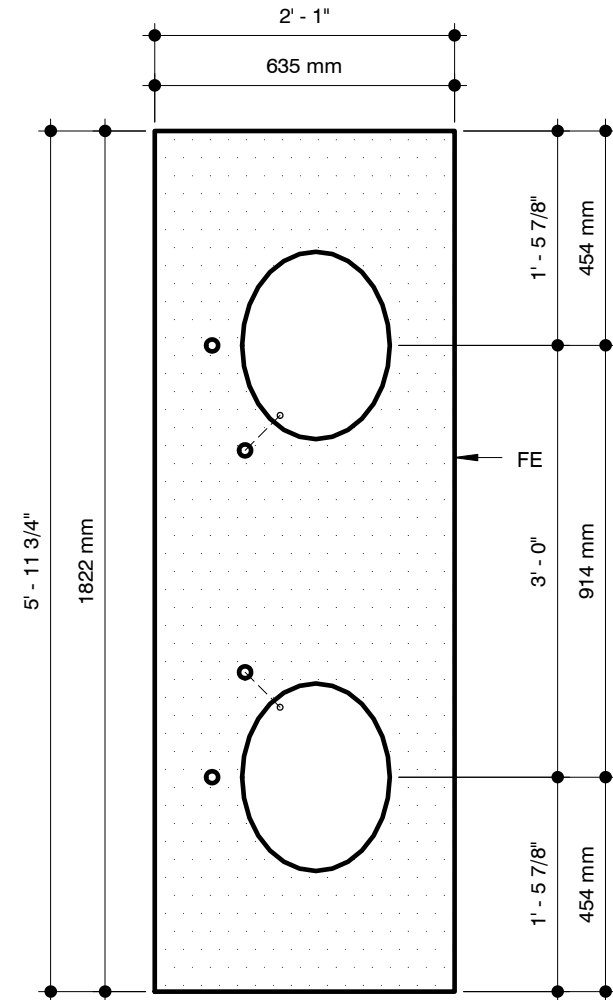

Stone Project Example

6250 Westpark Suite 218 Houston Texas 77057

Date: 02/27/09	Material: Tan Brown Granite	Finish: Polished	Thickness: 2cm	Ticket Number: TT3
----------------	-----------------------------	------------------	----------------	---------------------------

Mark	Stone Type	A		B		Quantity	Area	
		Imperial	Metric	Imperial	Metric		Imperial	Metric
CT4	ST-9	4' - 6 5/16"	1380 mm	4 1/16"	104 mm	34	52.397 SF	4.868 m ²
CT8	ST-9	5' - 11 3/4"	1822 mm	4 1/16"	104 mm	17	34.610 SF	3.215 m ²

Abbreviations
 FE - Finished Edge QME - Quirk Mitre Edge

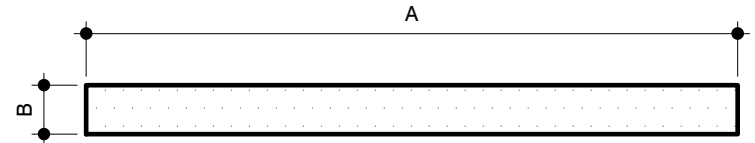

Stone Project Example

6250 Westpark Suite 218 Houston Texas 77057

Date: 02/27/09

Material: Tan Brown Granite

Finish: Polished

Thickness: 2cm

Ticket Number: **TT4**

Mark	Stone Type	A		B		Quantity	Area	
		Imperial	Metric	Imperial	Metric		Imperial	Metric
CT3	ST-9	4' - 6 5/16"	1380 mm	3 7/8"	98 mm	34	49.692 SF	4.617 m ²
CT7	ST-9	5' - 11 3/4"	1822 mm	3 7/8"	98 mm	17	32.823 SF	3.049 m ²

Abbreviations
 FE - Finished Edge QME - Quirk Mitre Edge

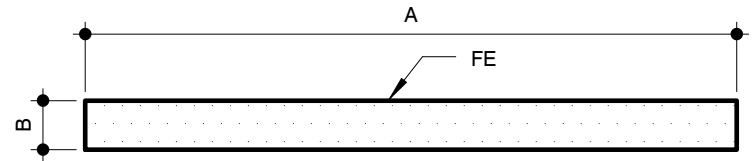

Stone Project Example

6250 Westpark Suite 218 Houston Texas 77057

Date: 02/27/09

Material: Tan Brown Granite

Finish: Polished

Thickness: 2cm

Ticket Number: **TT5**

Mark	Stone Type	Quantity	Area	
			Imperial	Metric
CT5	ST-9	34	22.037 SF	2.047 m ²

Abbreviations
 FE - Finished Edge QME - Quirk Mitre Edge

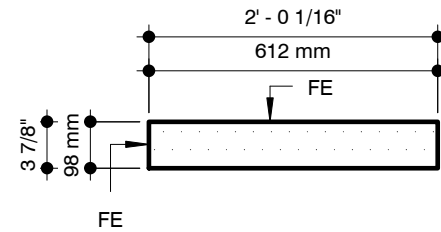

Stone Project Example

6250 Westpark Suite 218 Houston Texas 77057

Date: 02/27/09

Material: Tan Brown Granite

Finish: Polished

Thickness: 2cm

Ticket Number: **TT6**

Mark	Stone Type	Quantity	Area	
			Imperial	Metric
CT6	ST-9	34	22.037 SF	2.047 m ²

Abbreviations
 FE - Finished Edge QME - Quirk Mitre Edge

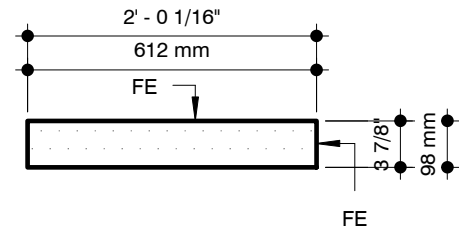

Stone Project Example

6250 Westpark Suite 218 Houston Texas 77057

Date: 02/27/09	Material: Tan Brown Granite	Finish: Polished	Thickness: 2cm	Ticket Number: TT7
----------------	-----------------------------	------------------	----------------	---------------------------

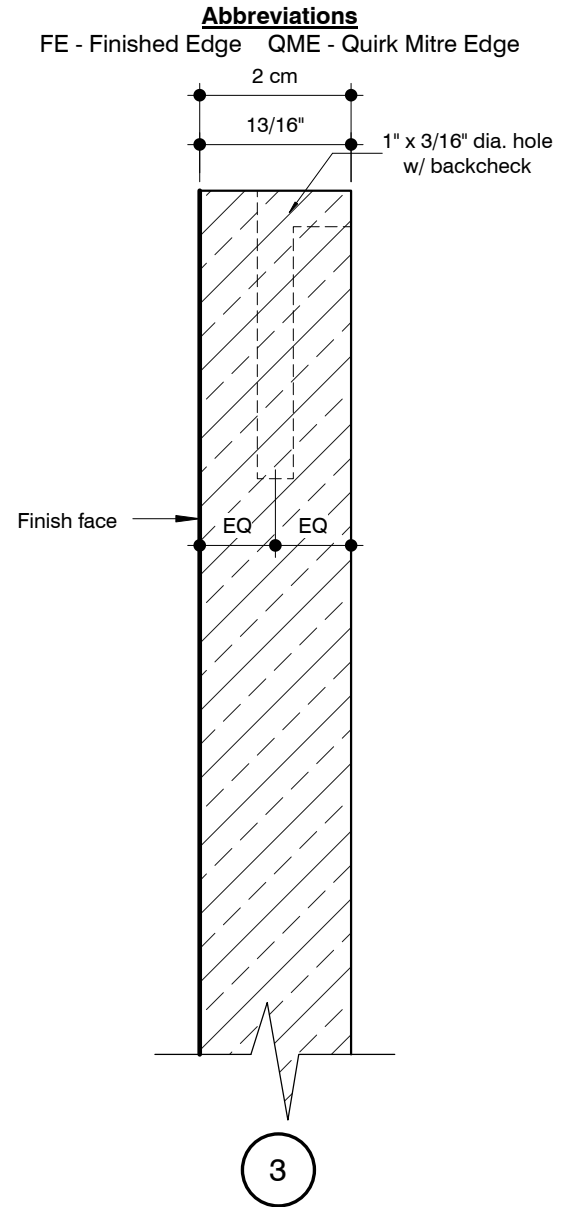
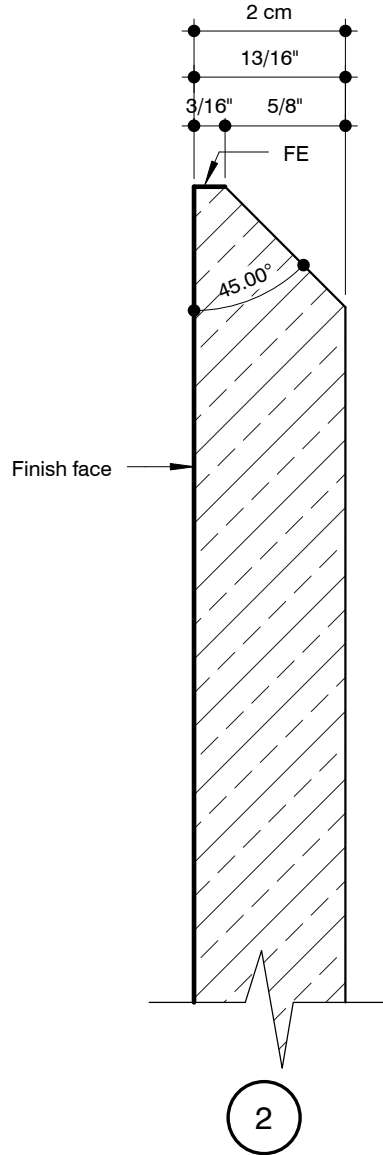
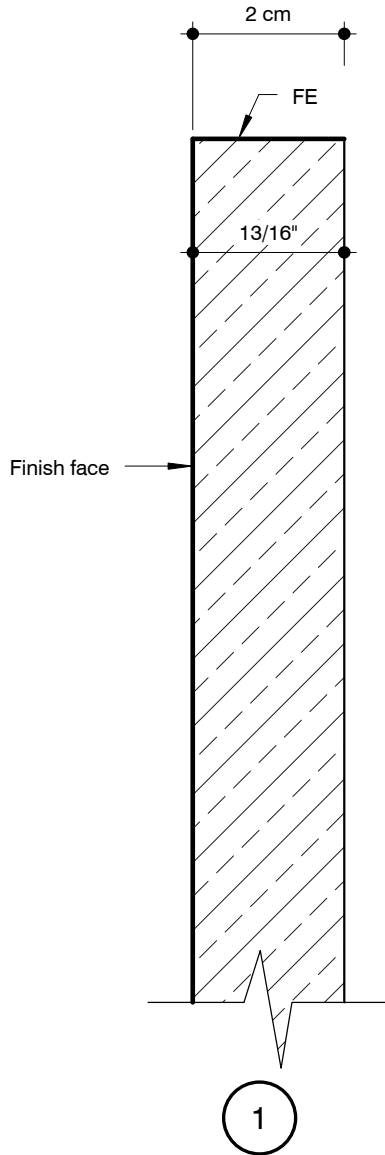

Stone Project Example

6250 Westpark Suite 218 Houston Texas 77057

Abbreviations

FE - Finished Edge QME - Quirk Mitre Edge

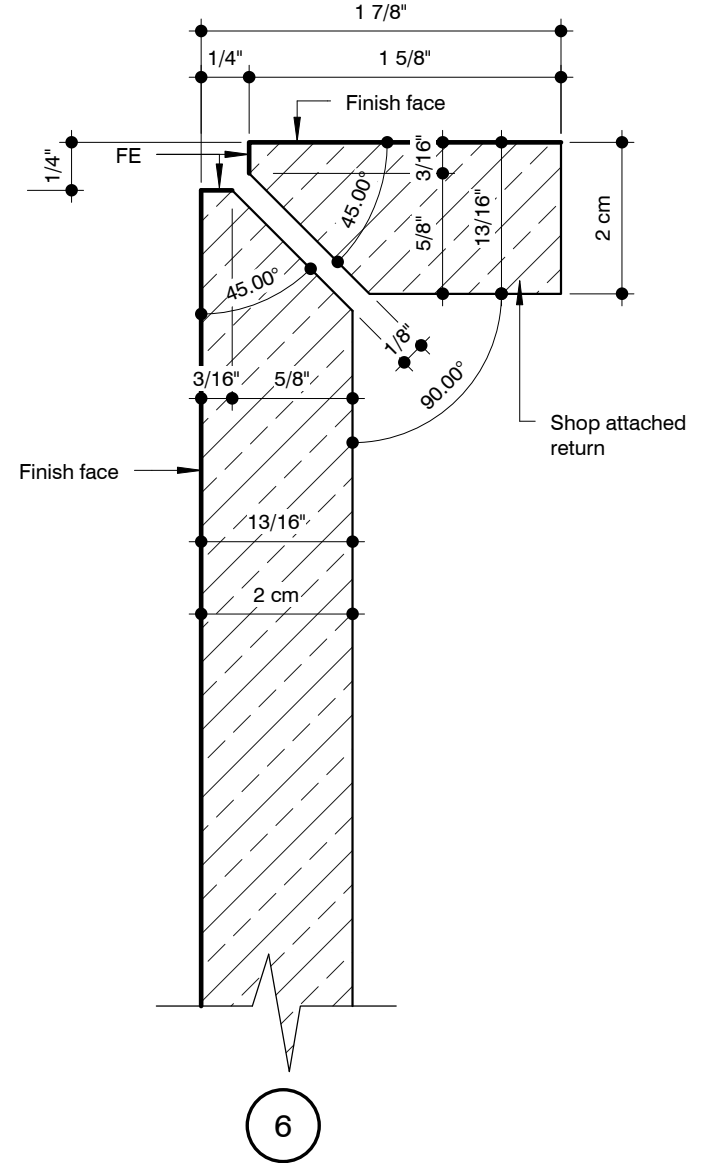
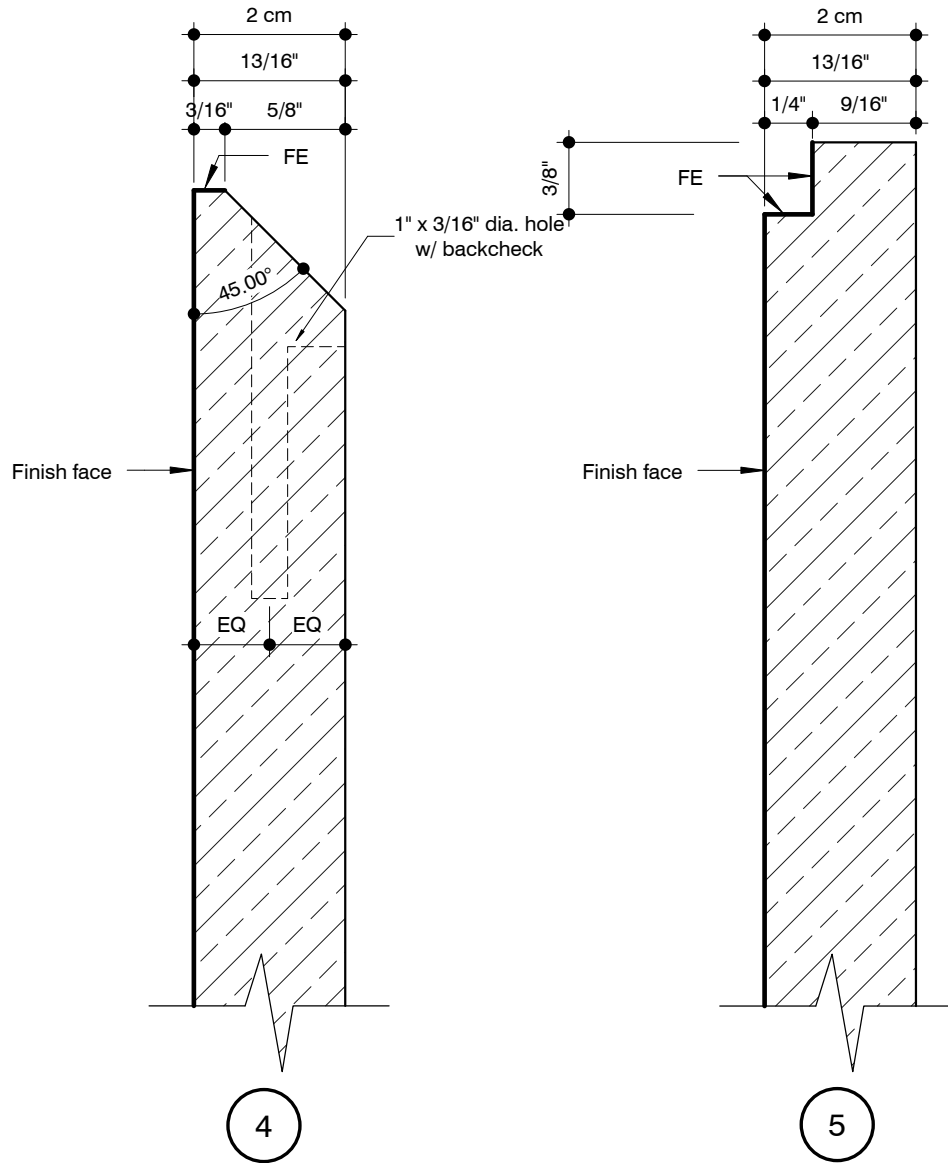

Stone Project Example

6250 Westpark Suite 218 Houston Texas 77057

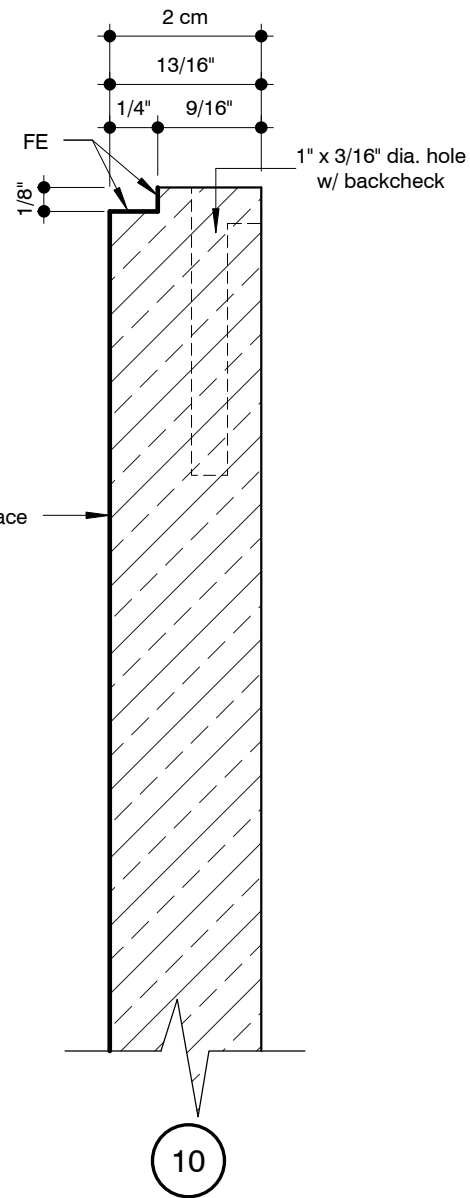
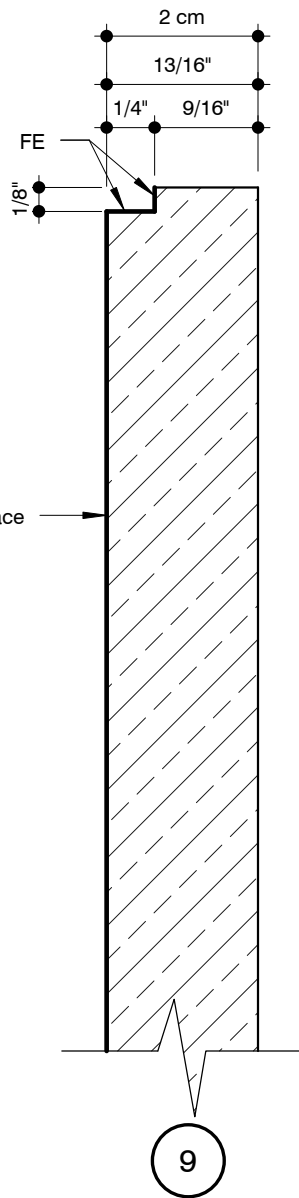

Abbreviations
 FE - Finished Edge QME - Quirk Mitre Edge

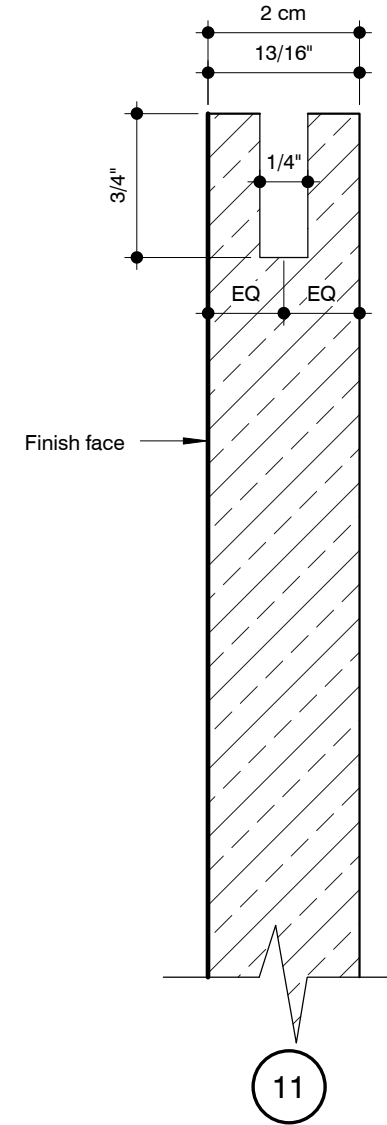

Stone Project Example

6250 Westpark Suite 218 Houston Texas 77057

Date: 02/23/09

Details

Ticket Number: **TX-4**

Abbreviations

FE - Finished Edge QME - Quirk Mitre Edge

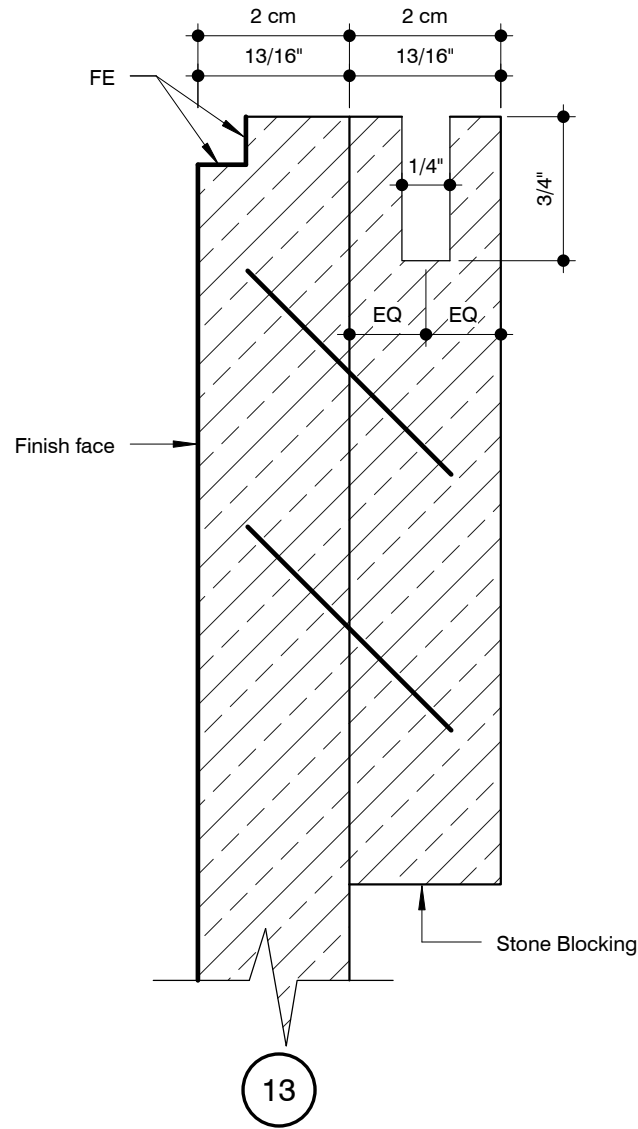
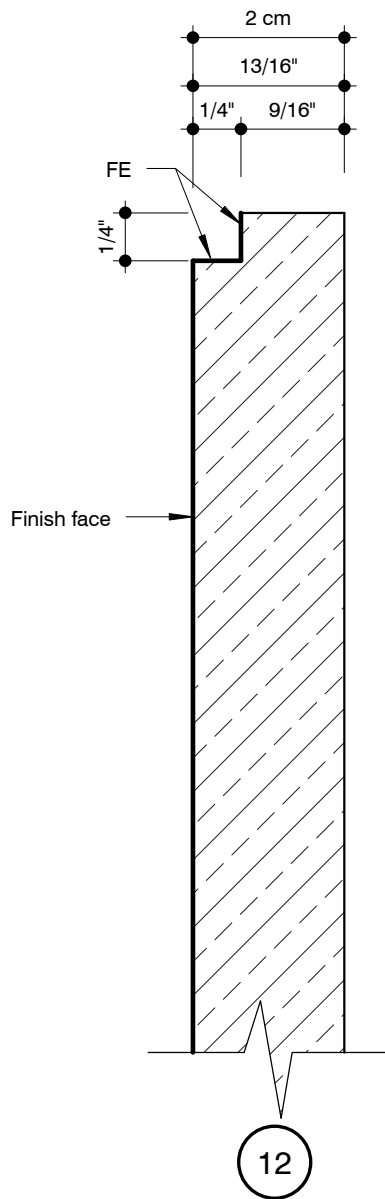

Stone Project Example

6250 Westpark Suite 218 Houston Texas 77057

Date: 02/23/09

Details

Ticket Number: **TX-5**