

DRAFTING		MOLD SHOP		PRODUCTION	
DATE: Lifestyle USA Design	DATE:	MOLD I.D. #	DATE:		
DRAWN BY:	MADE BY:	MOLD DISPOSAL CODE	TAMPED BY:		
CHECKED BY:	CHECKED BY:		CHECKED BY:		
JOB #:	COLOR:	SCALE: 1 1/2" = 1'-0"	DATE: 08/13/08		
Bench Assignment: Block 274 East		PROJECT: Houston Pavilions		MARK: BS45	

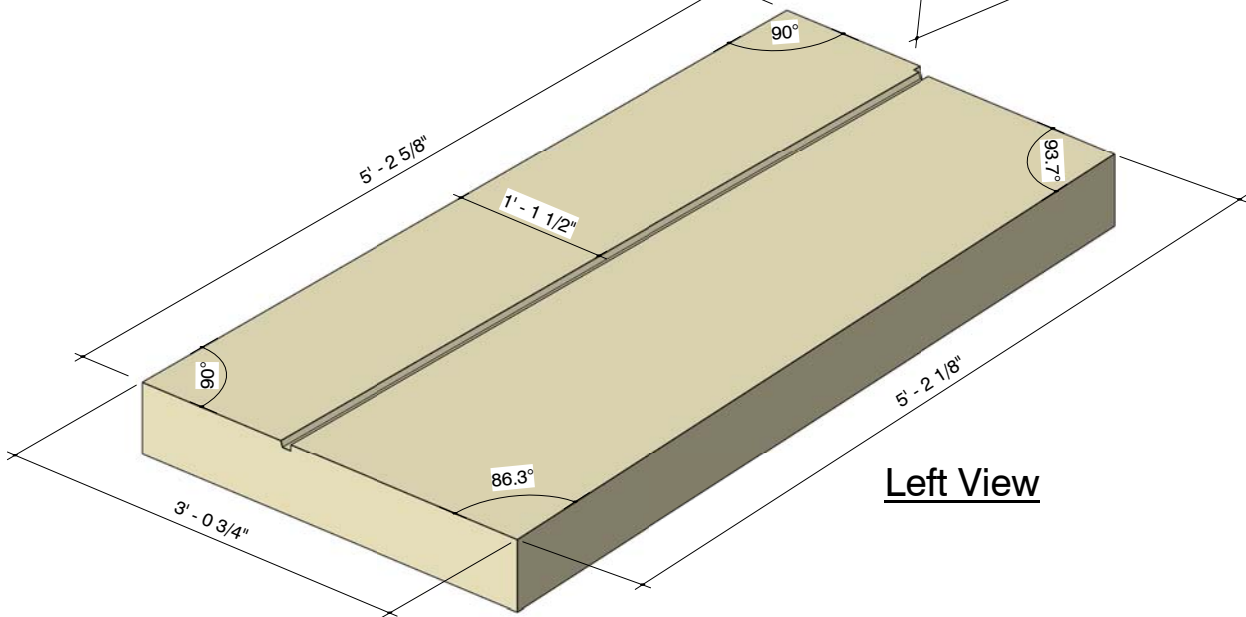

DRAFTING		MOLD SHOP		PRODUCTION	
DATE: Lifestyle USA Design	DATE:	MOLD I.D. #	DATE:		
DRAWN BY:	MADE BY:	MOLD DISPOSAL CODE	TAMPED BY:		
CHECKED BY:	CHECKED BY:		CHECKED BY:		
JOB #:	COLOR:	SCALE: 1 1/2" = 1'-0"	DATE: 08/14/08	MARK: BS44	
Bench Assignment: Block 274 East		PROJECT: Houston Pavilions			

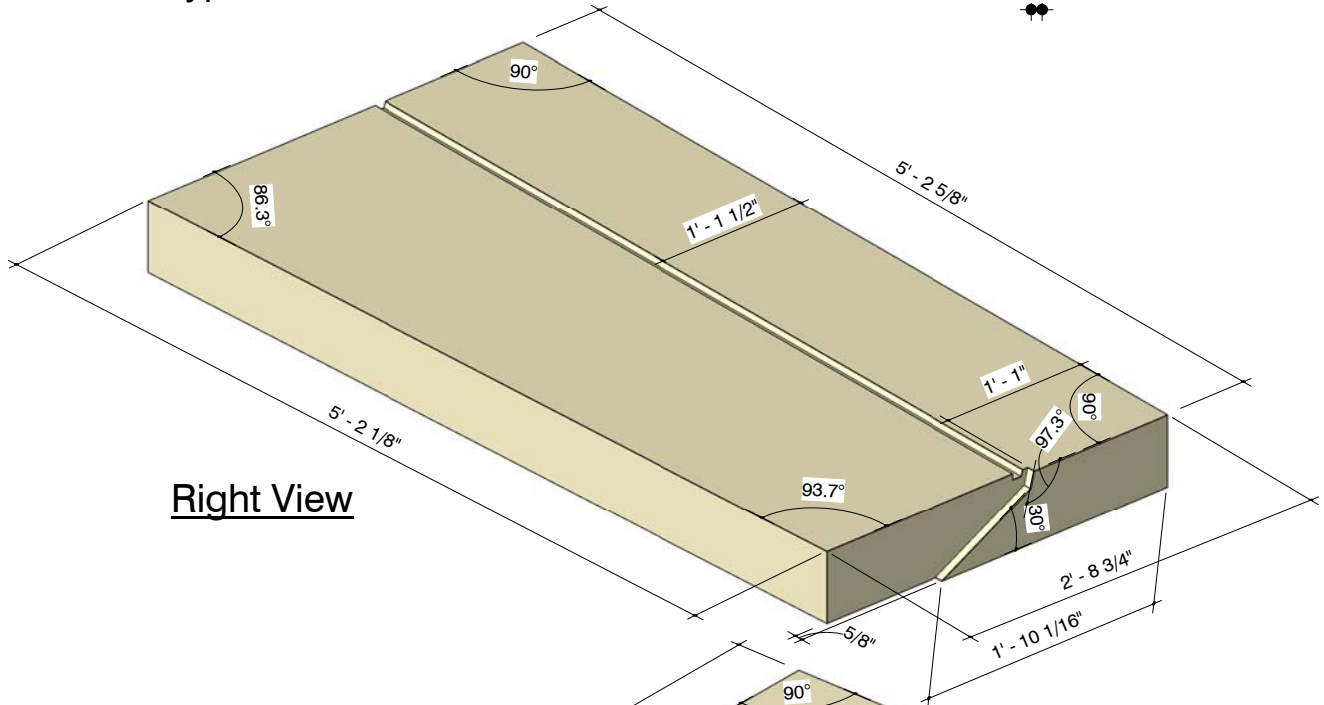
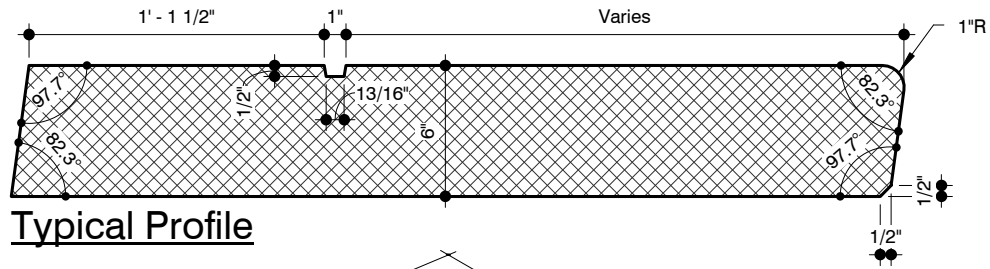
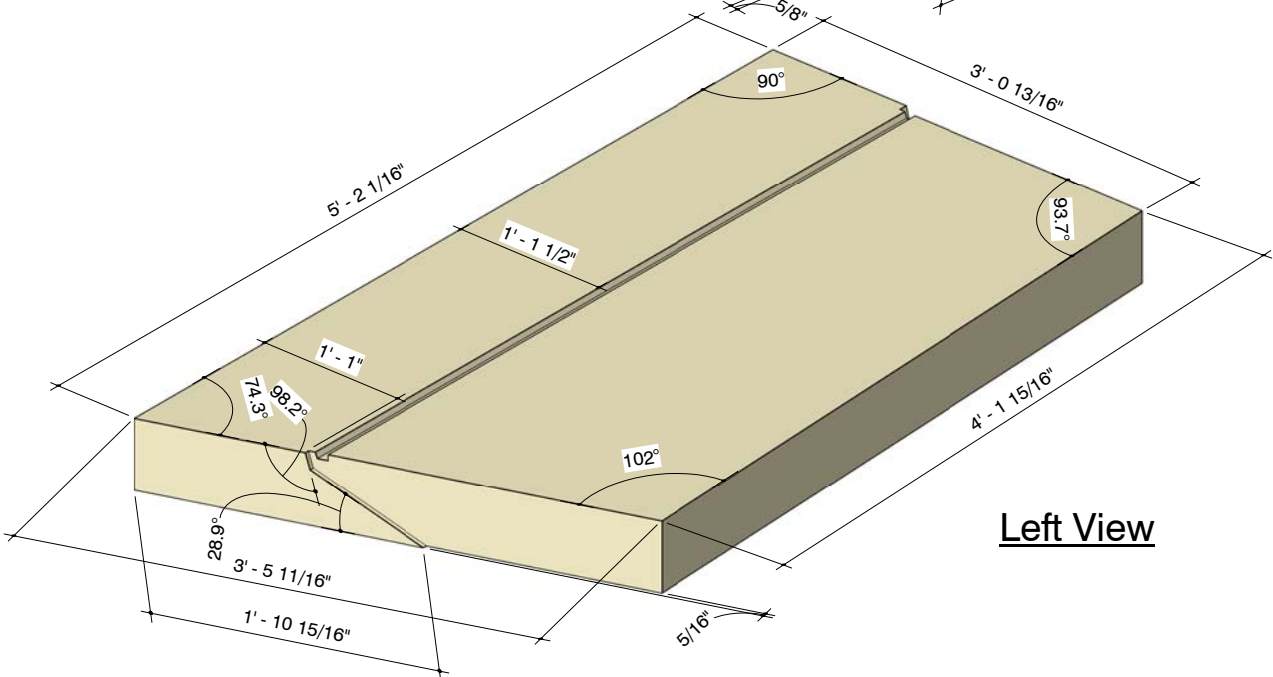
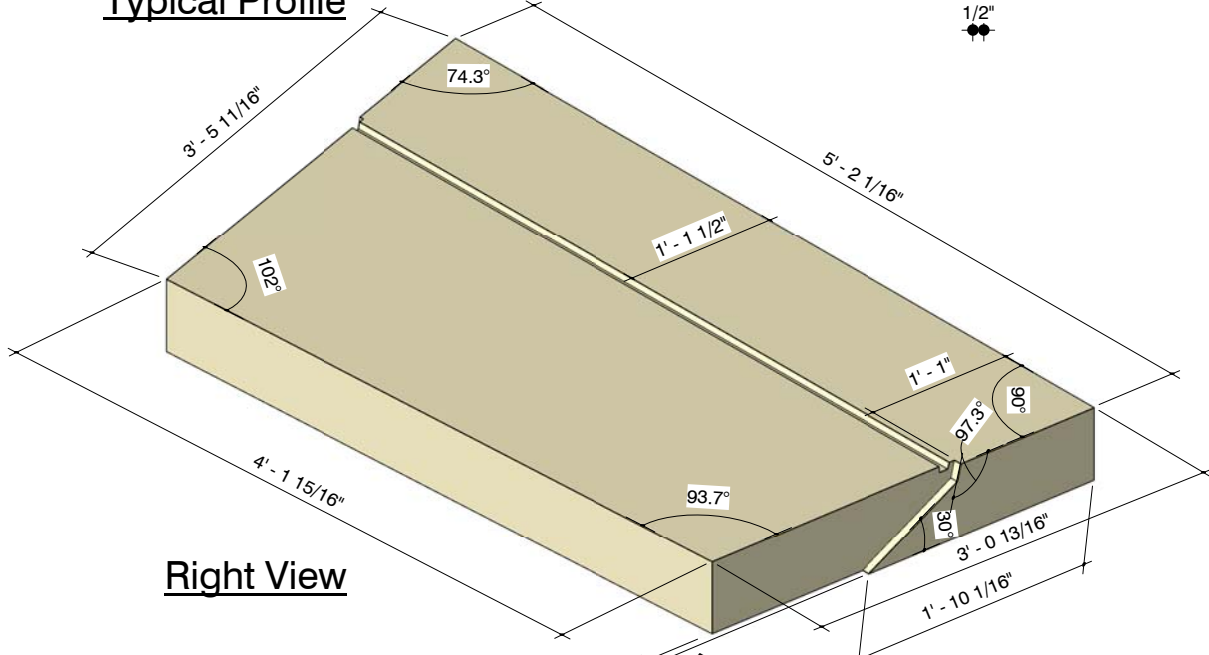
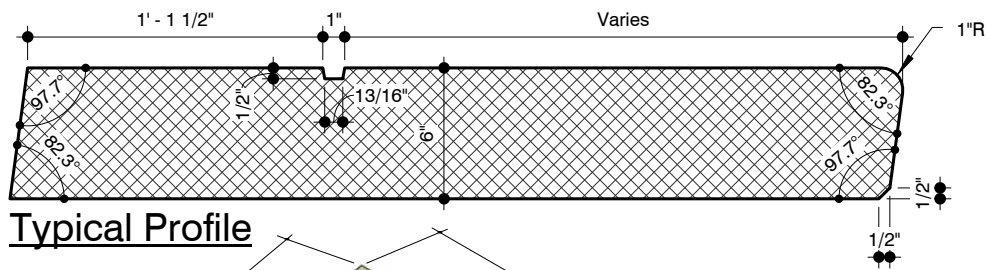

DRAFTING		MOLD SHOP		PRODUCTION	
DATE: Lifestyle USA Design	DATE:	MOLD I.D. #	DATE:		
DRAWN BY:	MADE BY:	MOLD DISPOSAL CODE	TAMPED BY:		
CHECKED BY:	CHECKED BY:		CHECKED BY:		
JOB #:	COLOR:	SCALE: 1 1/2" = 1'-0"	DATE: 08/14/08	MARK: BS43	
Bench Assignment: Block 274 East		PROJECT: Houston Pavilions			

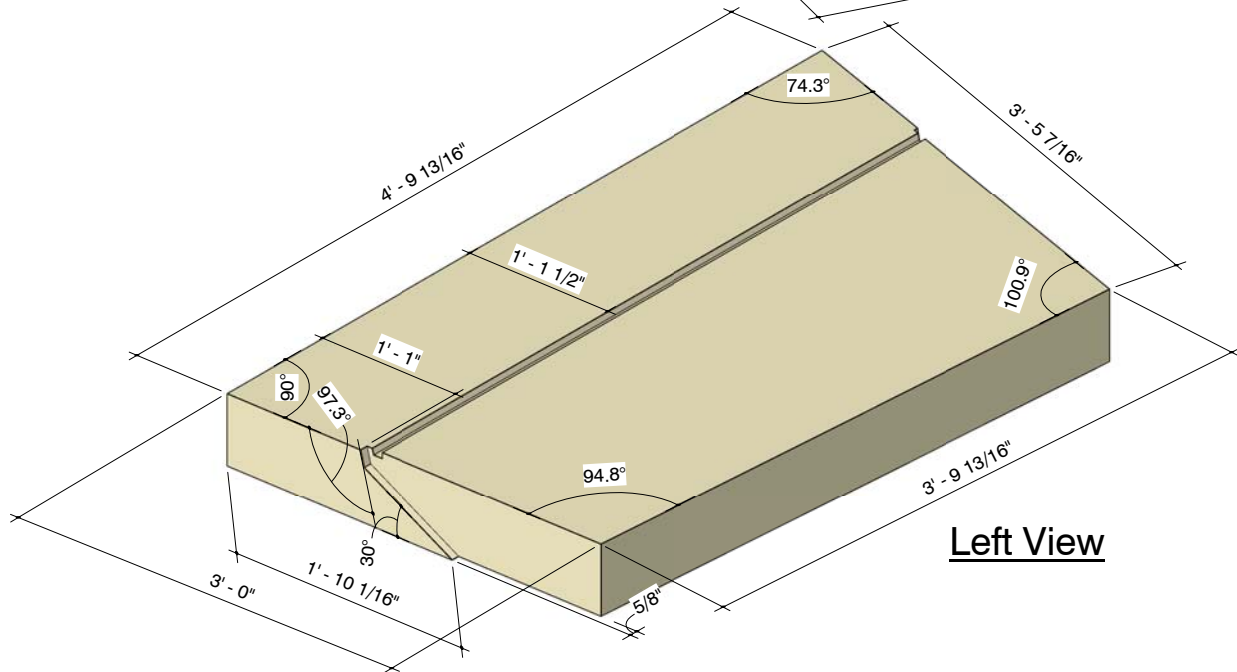
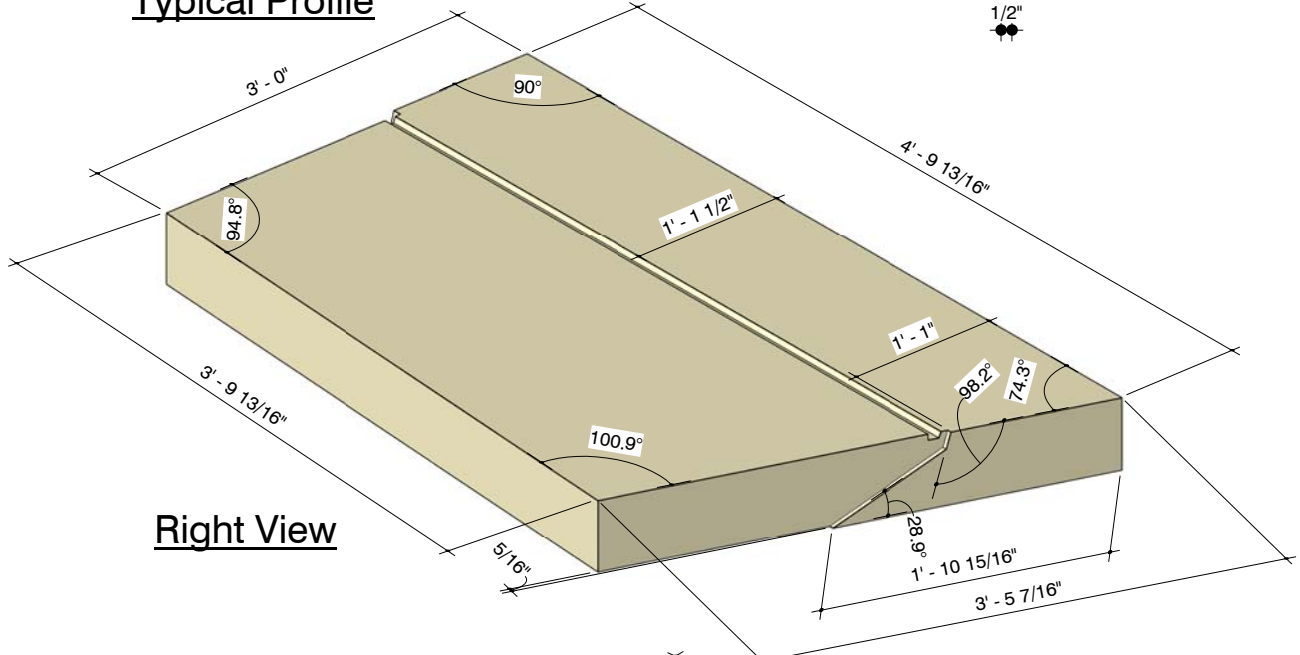
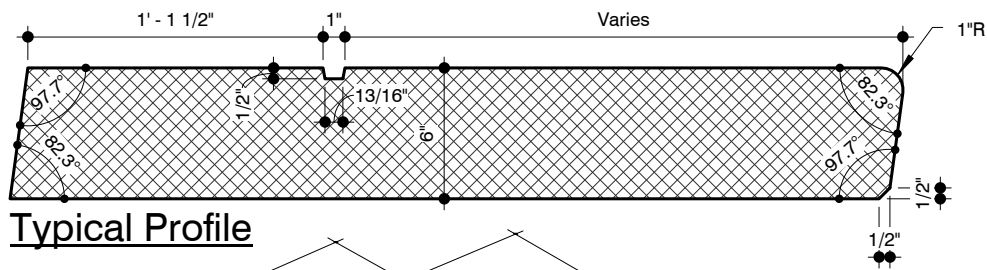

DRAFTING		MOLD SHOP		PRODUCTION	
DATE: Lifestyle USA Design	DATE:	MOLD I.D. #	DATE:		
DRAWN BY:	MADE BY:	MOLD DISPOSAL CODE	TAMPED BY:		
CHECKED BY:	CHECKED BY:		CHECKED BY:		
JOB #:	COLOR:	SCALE: 1 1/2" = 1'-0"	DATE: 08/14/08		
Bench Assignment: Block 274 East		PROJECT: Houston Pavilions			

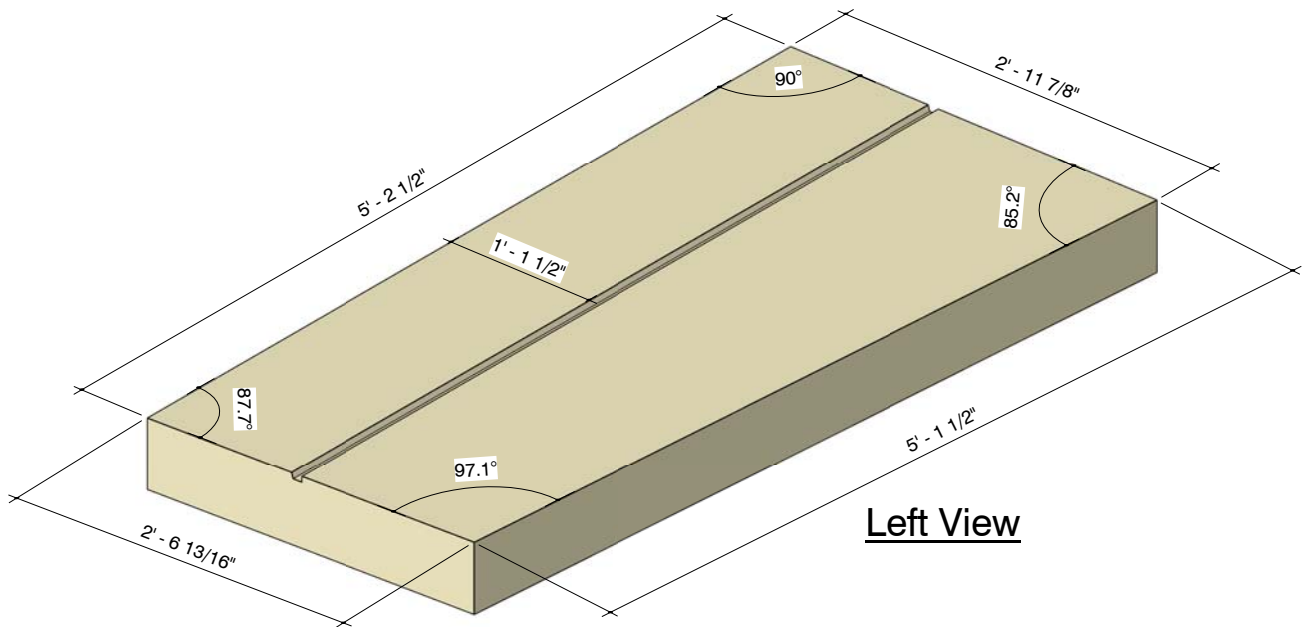
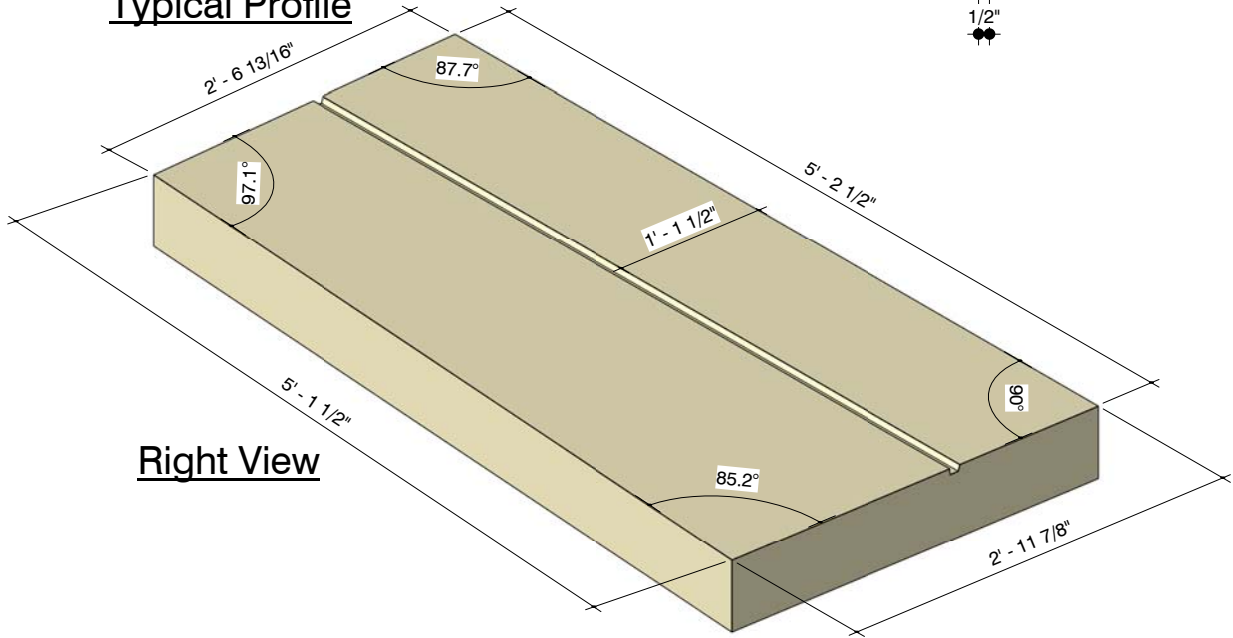
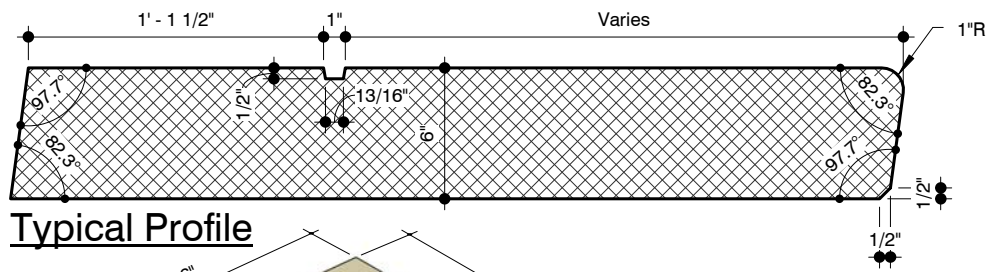

DRAFTING		MOLD SHOP		PRODUCTION	
DATE: Lifestyle USA Design	DATE:	MOLD I.D. #	DATE:		
DRAWN BY:	MADE BY:	MOLD DISPOSAL CODE	TAMPED BY:		
CHECKED BY:	CHECKED BY:		CHECKED BY:		
JOB #:	COLOR:	SCALE: 1 1/2" = 1'-0"	DATE: 08/14/08	MARK: BS41	
Bench Assignment: Block 274 East		PROJECT: Houston Pavilions			

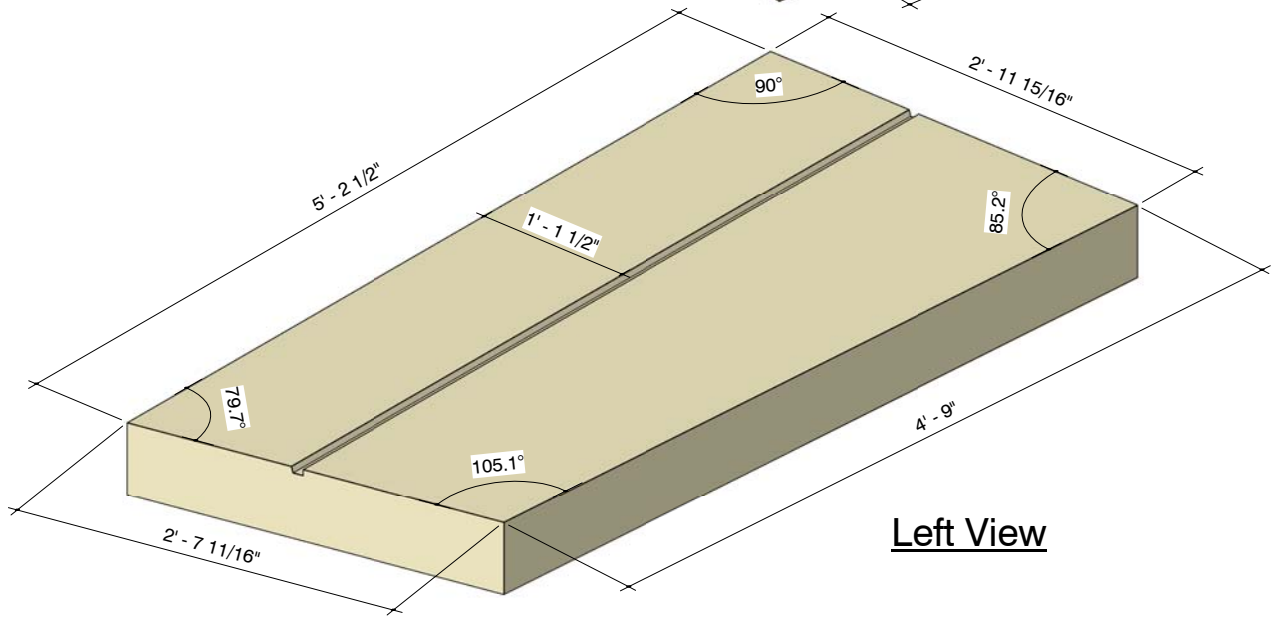
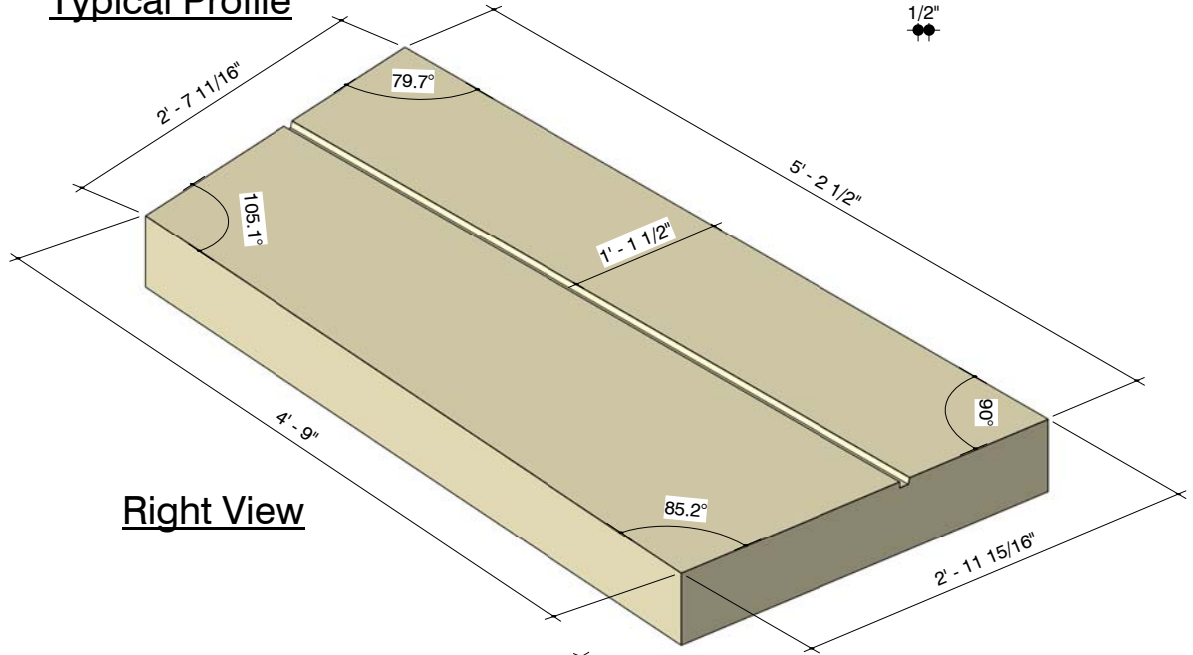
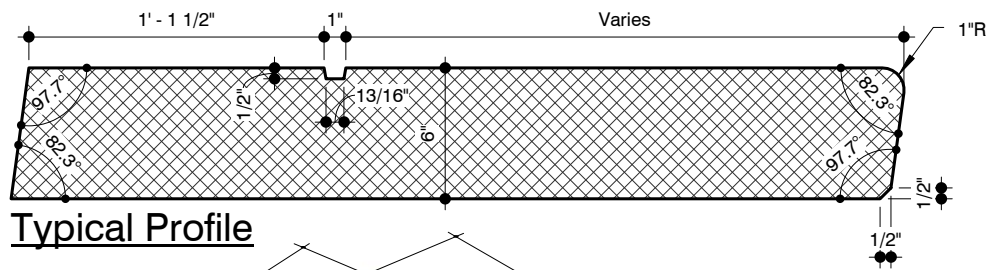

DRAFTING		MOLD SHOP		PRODUCTION	
DATE: Lifestyle USA Design	DATE:	MOLD I.D. #	DATE:		
DRAWN BY:	MADE BY:	MOLD DISPOSAL CODE	TAMPED BY:		
CHECKED BY:	CHECKED BY:		CHECKED BY:		
JOB #:	COLOR:	SCALE: 1 1/2" = 1'-0"	DATE: 08/14/08	MARK: BS46	
Bench Assignment: Block 274 East		PROJECT: Houston Pavilions			

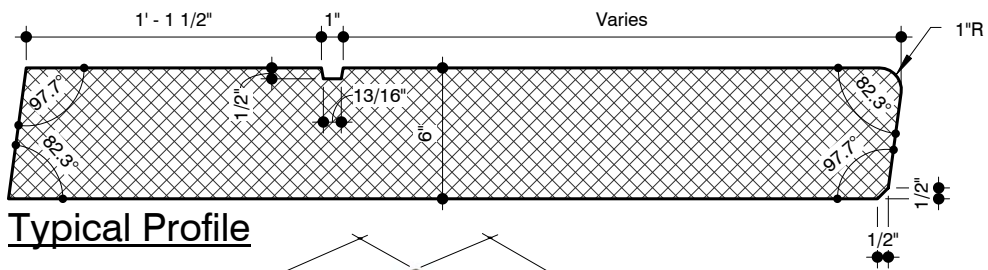

Typical Profile

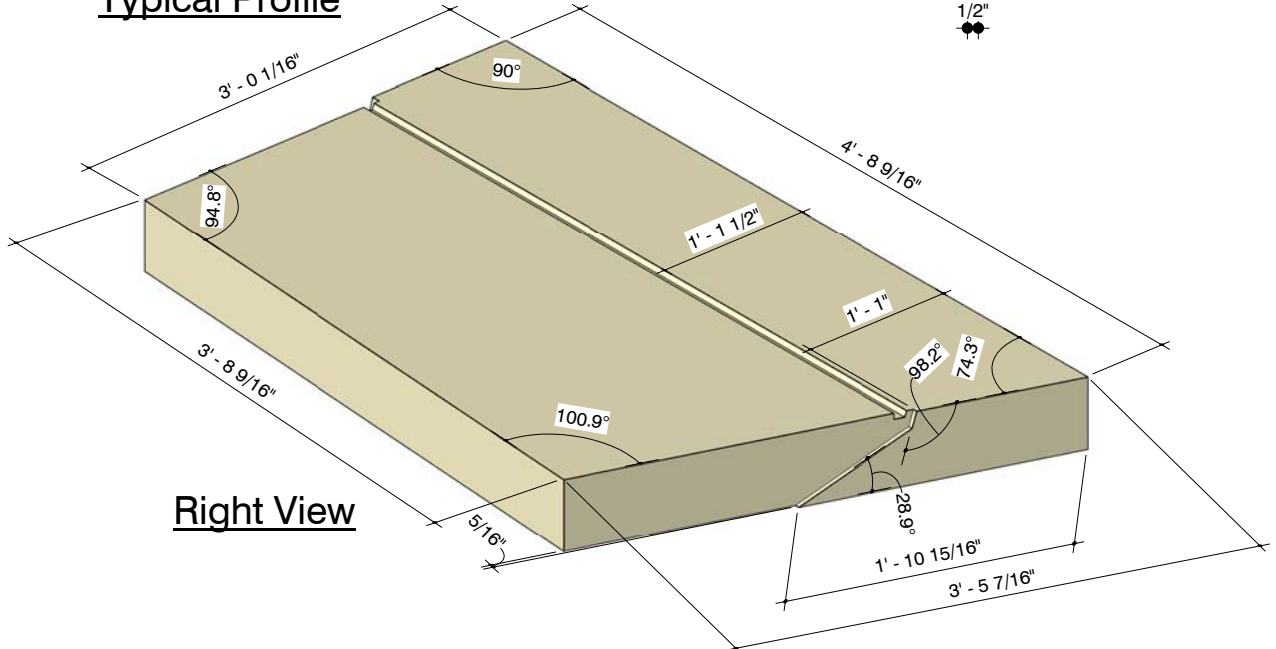

Right View

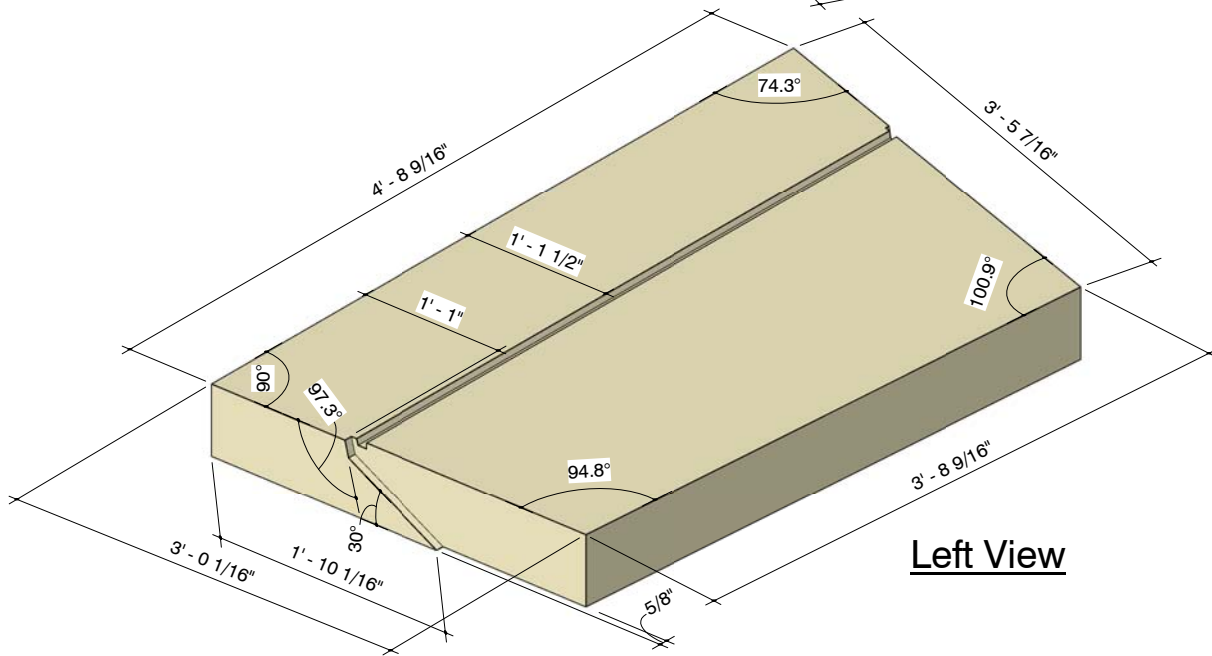

Left View

DRAFTING		MOLD SHOP		PRODUCTION	
DATE: Lifestyle USA Design	DATE:	MOLD I.D. #	DATE:		
DRAWN BY:	MADE BY:	MOLD DISPOSAL CODE	TAMPED BY:		
CHECKED BY:	CHECKED BY:		CHECKED BY:		
JOB #:	COLOR:	SCALE: 1 1/2" = 1'-0"	DATE: 08/14/08	MARK: BS47	
Bench Assignment: Block 274 East		PROJECT: Houston Pavilions			

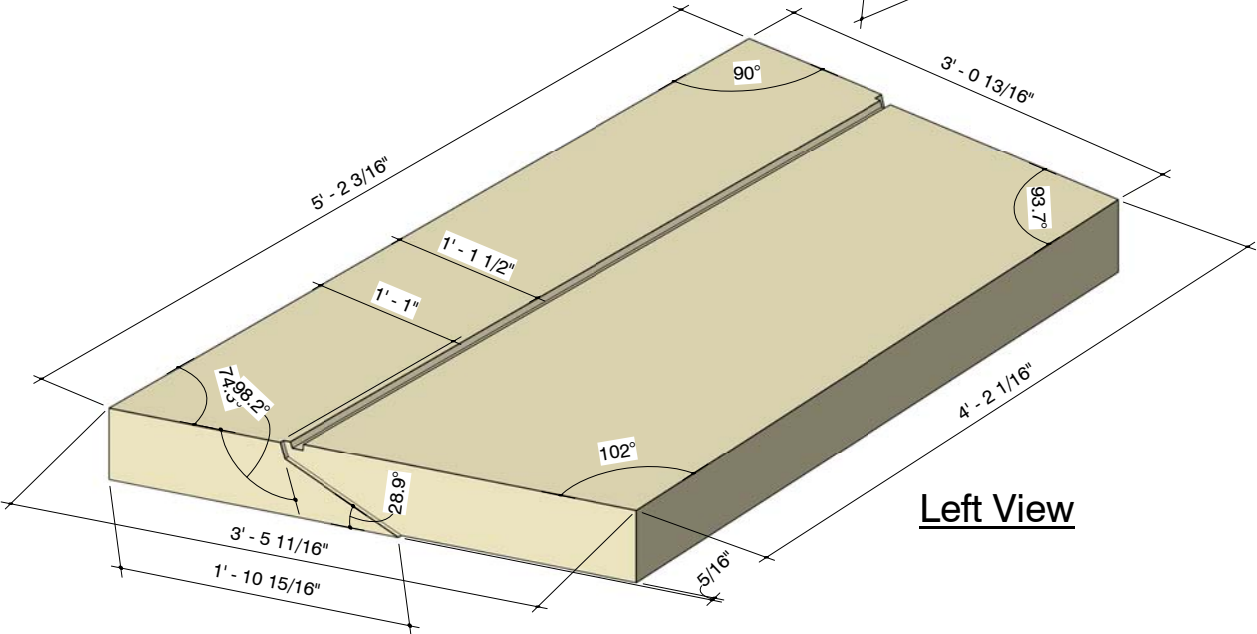
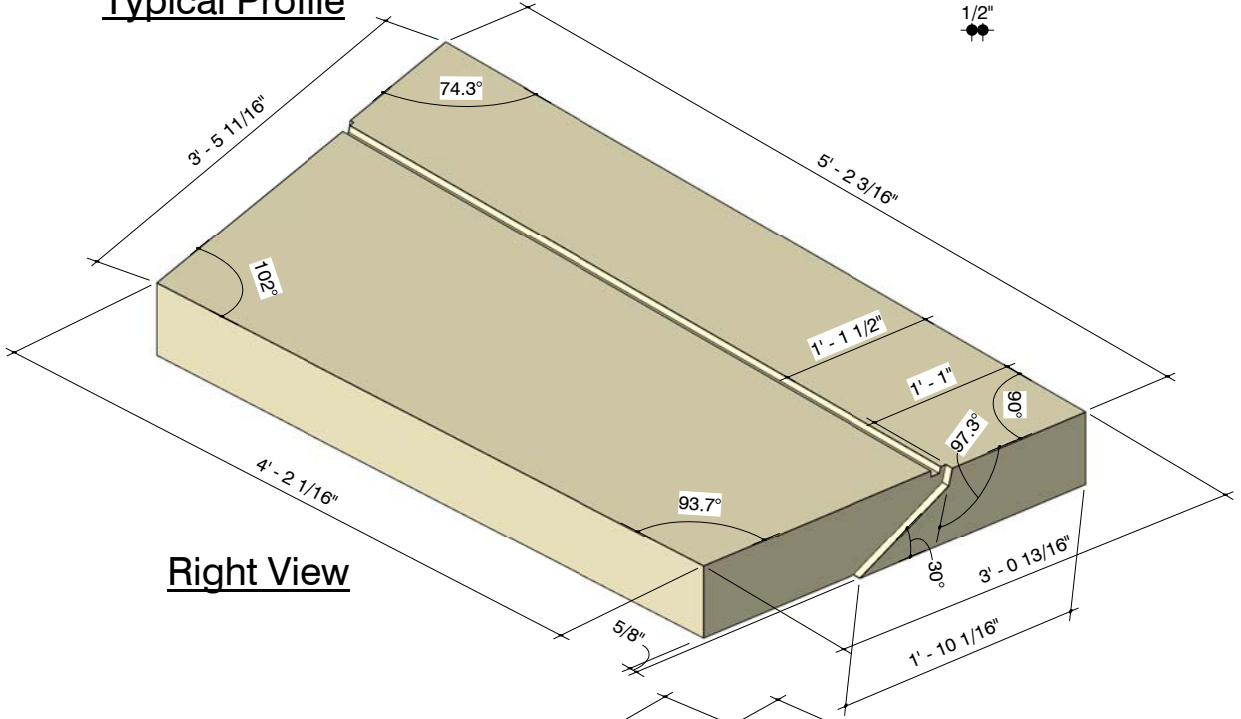
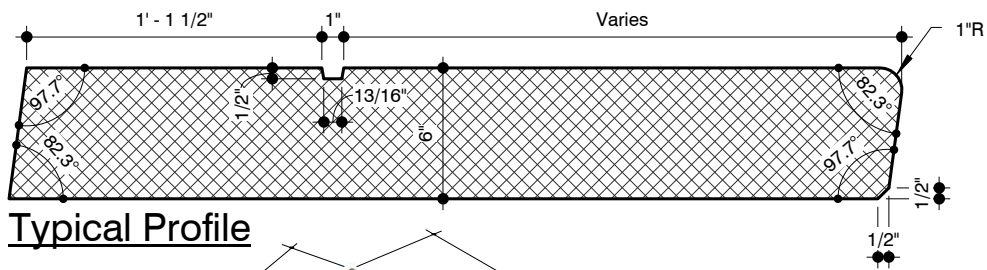

DRAFTING		MOLD SHOP		PRODUCTION	
DATE: Lifestyle USA Design	DATE:	MOLD I.D. #	DATE:		
DRAWN BY:	MADE BY:	MOLD DISPOSAL CODE	TAMPED BY:		
CHECKED BY:	CHECKED BY:		CHECKED BY:		
JOB #:	COLOR:	SCALE: 1 1/2" = 1'-0"	DATE: 08/14/08		
Bench Assignment: Block 274 East		PROJECT: Houston Pavilions		MARK: BS48	

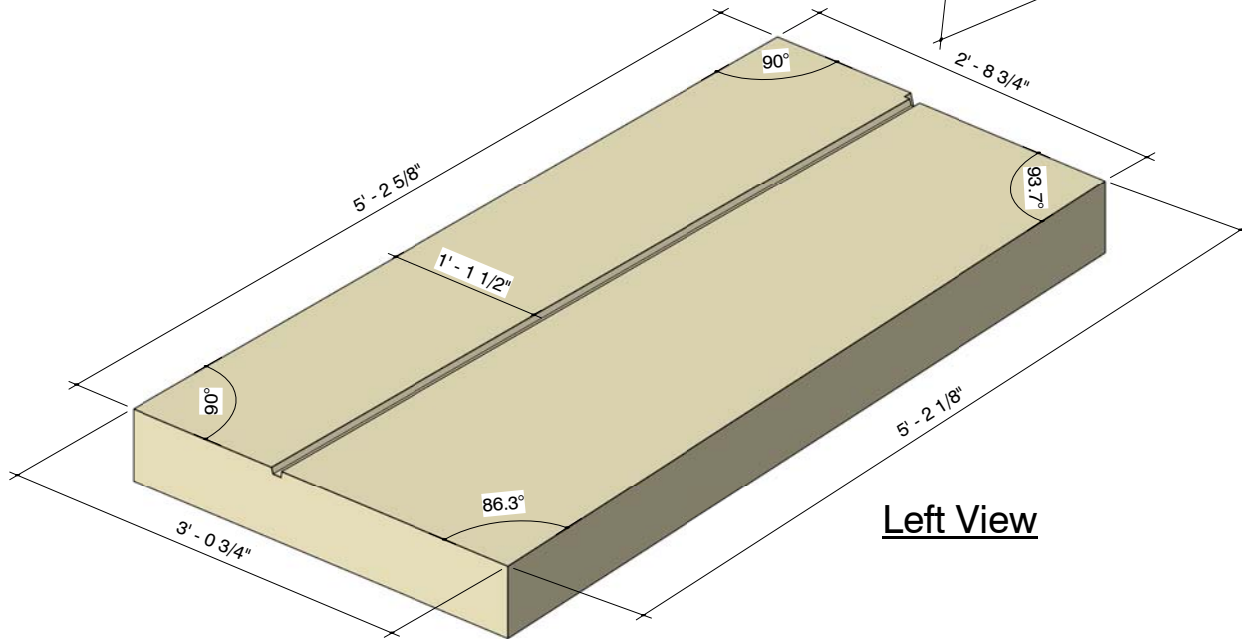
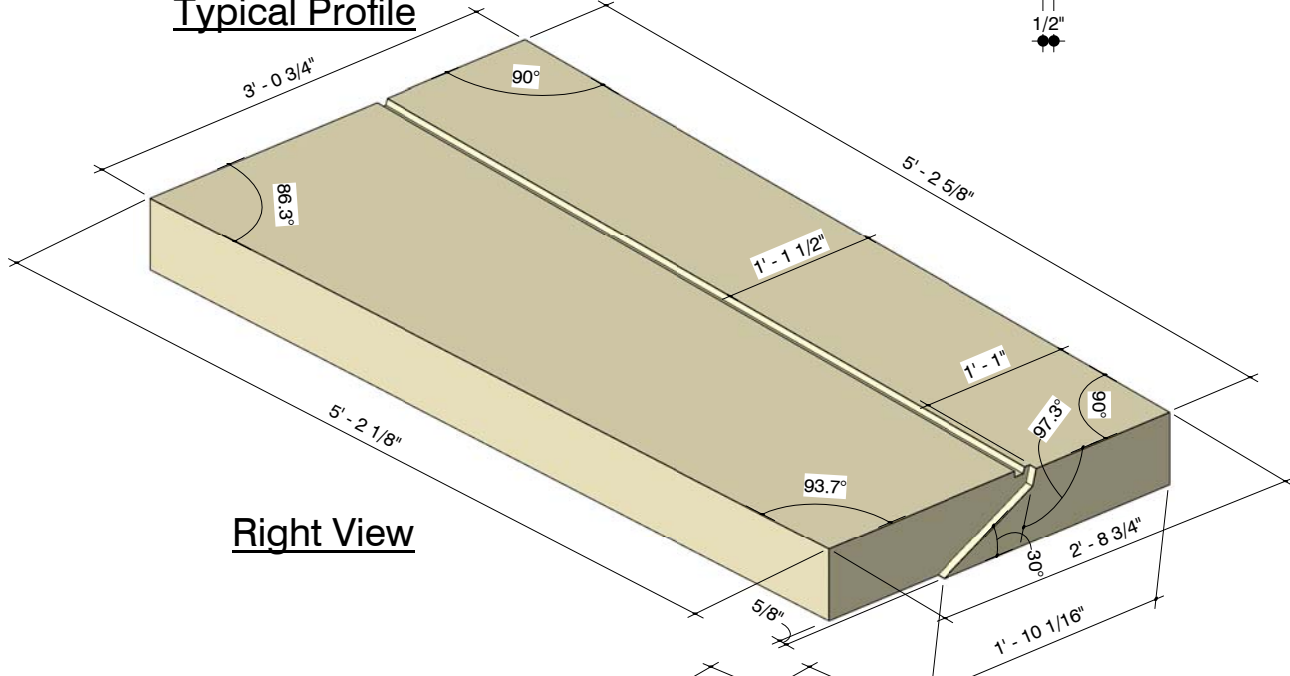
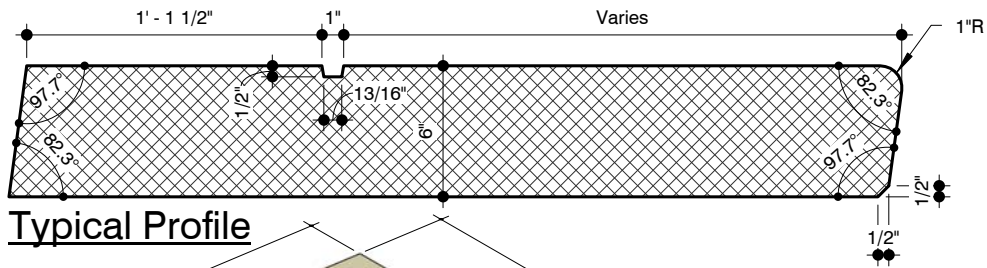

DRAFTING		MOLD SHOP		PRODUCTION	
DATE: Lifestyle USA Design	DATE:	MOLD I.D. #	DATE:		
DRAWN BY:	MADE BY:	MOLD DISPOSAL CODE	TAMPED BY:		
CHECKED BY:	CHECKED BY:		CHECKED BY:		
JOB #:	COLOR:	SCALE: 1 1/2" = 1'-0"	DATE: 08/14/08	MARK: BS49	
Bench Assignment: Block 274 East		PROJECT: Houston Pavilions			

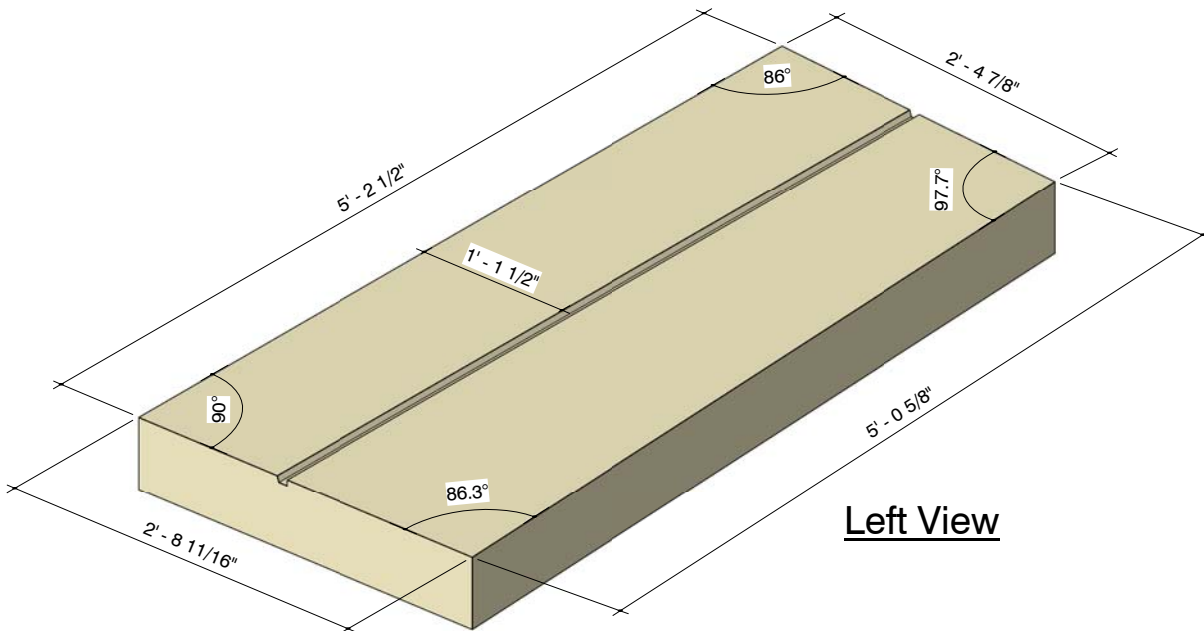
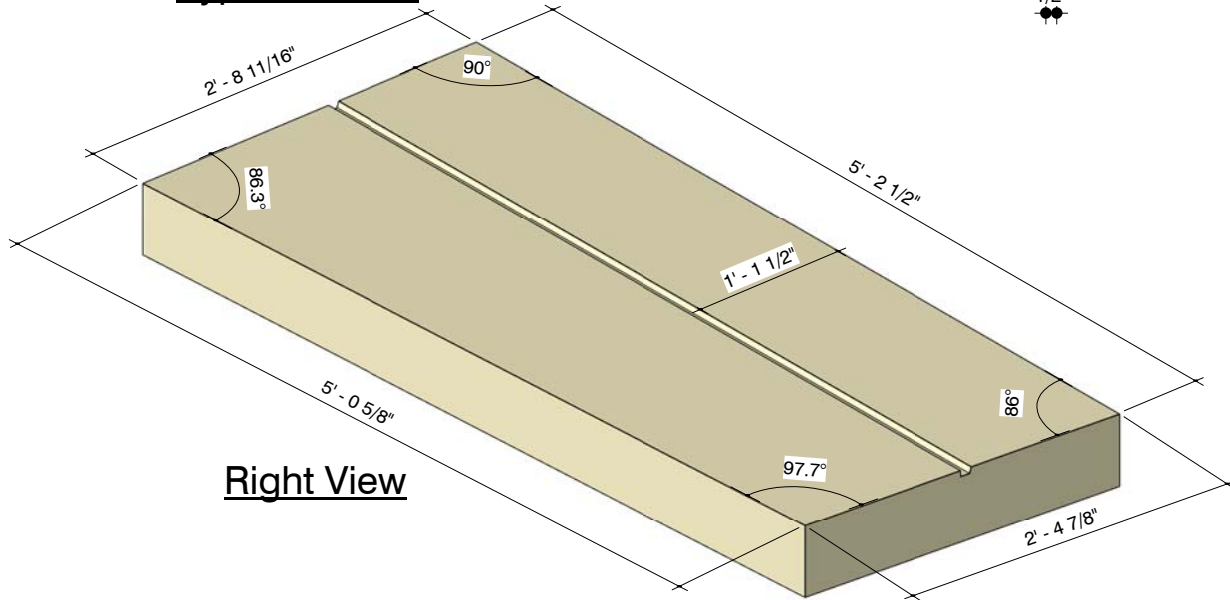
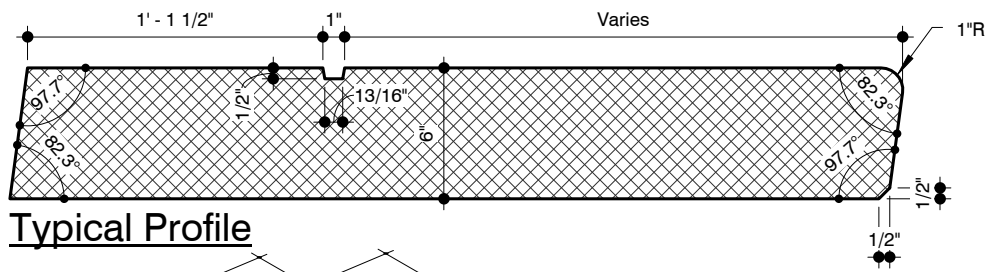

DRAFTING		MOLD SHOP		PRODUCTION	
DATE: Lifestyle USA Design	DATE:	MOLD I.D. #	DATE:		
DRAWN BY:	MADE BY:	MOLD DISPOSAL CODE	TAMPED BY:		
CHECKED BY:	CHECKED BY:		CHECKED BY:		
JOB #:	COLOR:	SCALE: 1 1/2" = 1'-0"	DATE: 08/14/08	MARK: BS50	
Bench Assignment: Block 274 East		PROJECT: Houston Pavilions			

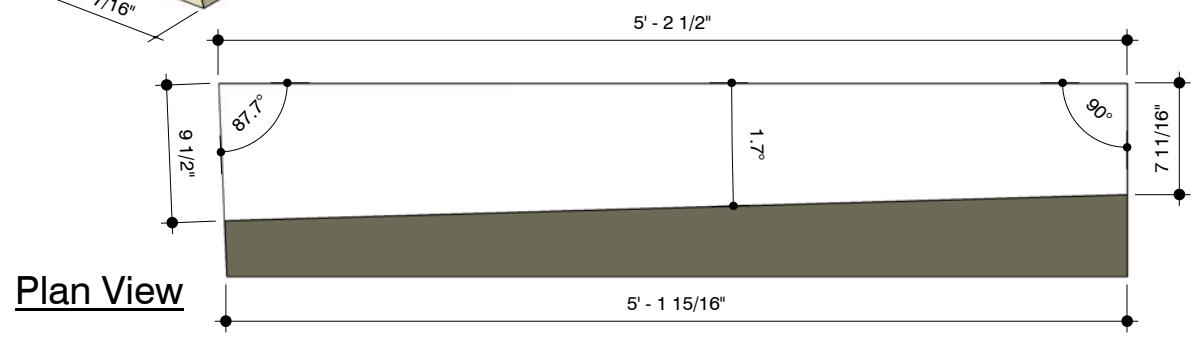
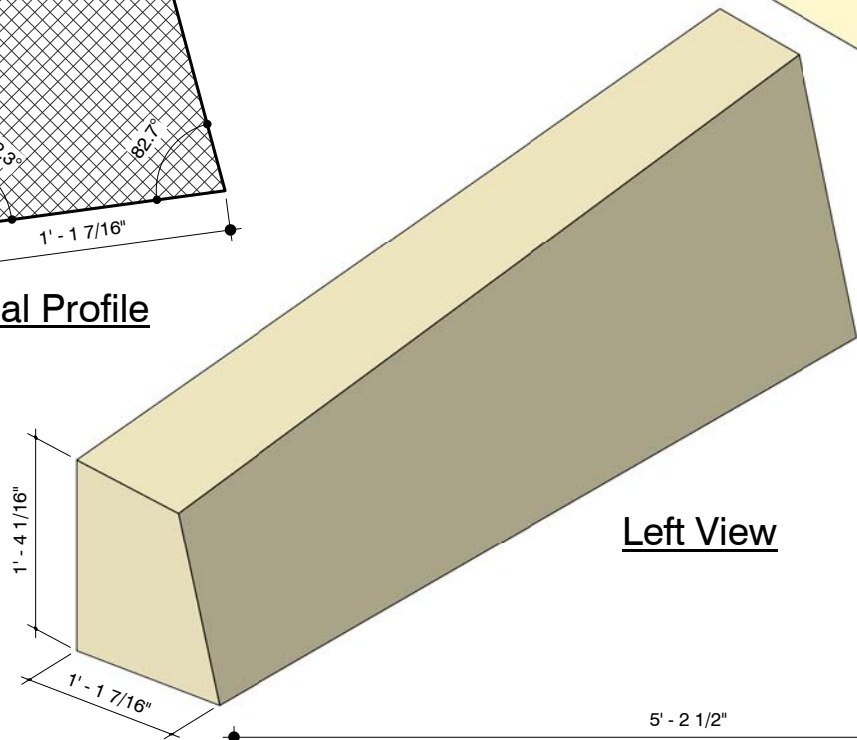
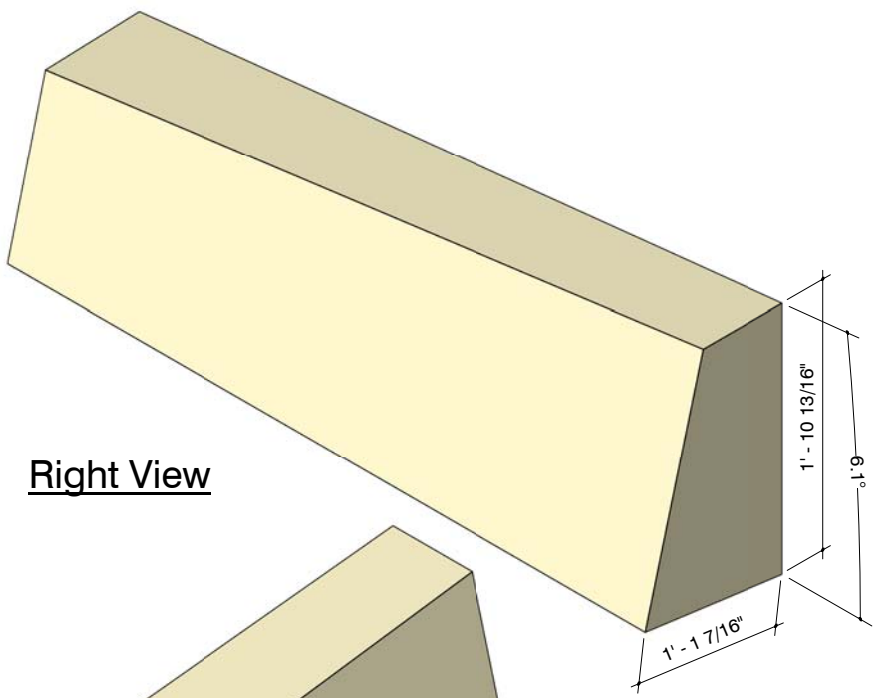
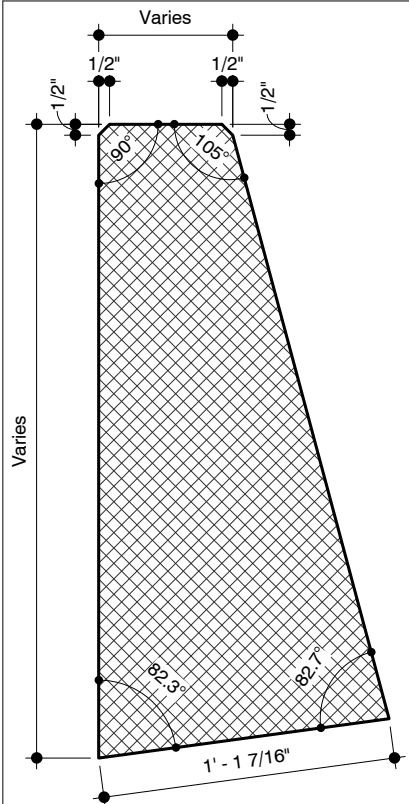

DRAFTING		MOLD SHOP		PRODUCTION		CUT WORK	
DATE: Lifestyle USA Design	DATE:	MOLD I.D. #	DATE:				
DRAWN BY:	MADE BY:	MOLD DISPOSAL CODE	TAMPED BY:				
CHECKED BY:	CHECKED BY:		CHECKED BY:				
JOB #:	COLOR:	SCALE: 1 1/2" = 1'-0"	DATE: 08/14/08	Member			
Bench Assignment: Block 274 East		PROJECT: Houston Pavilions		MARK: BB41			

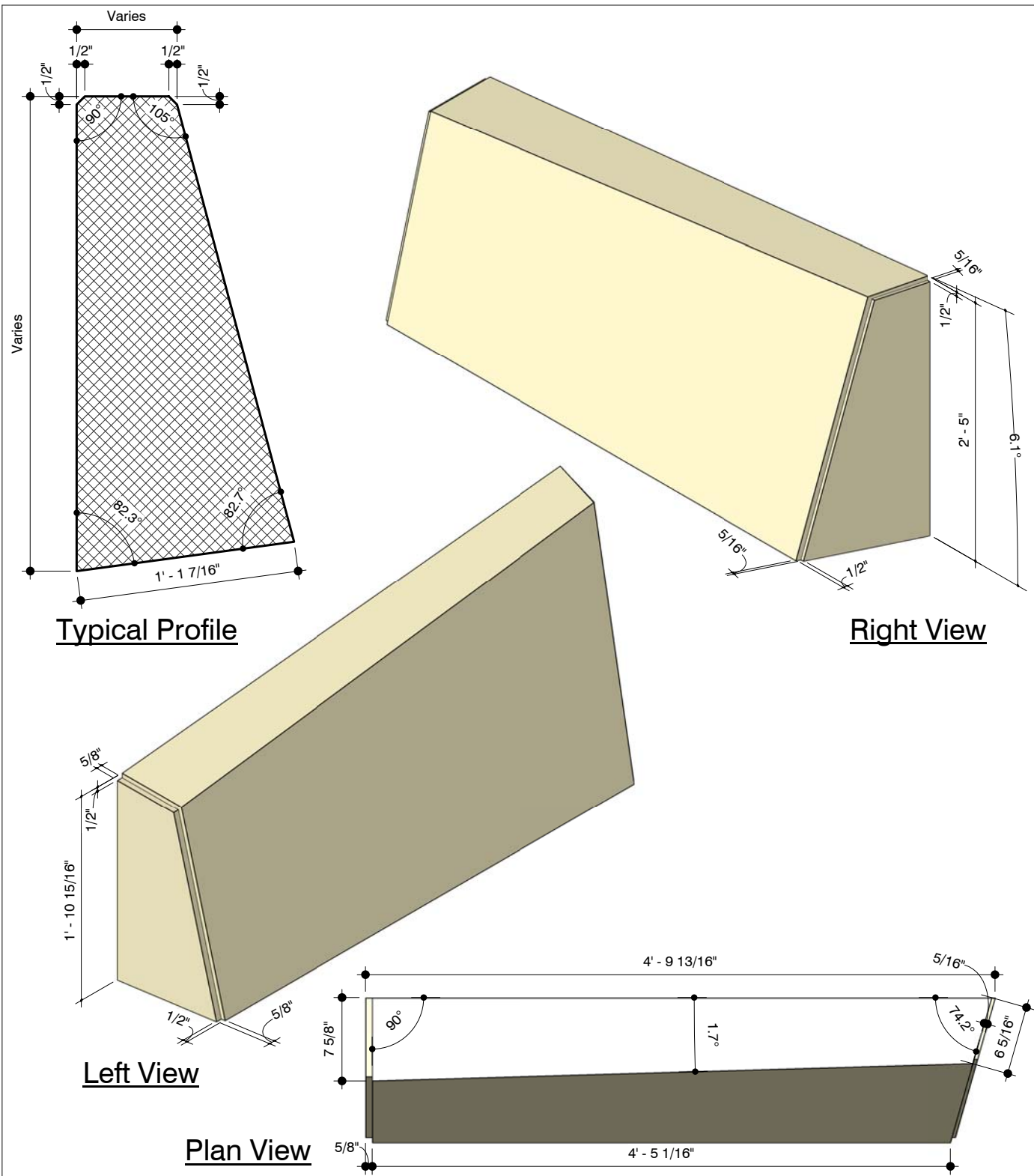

Typical Profile

Right View

Left View

Plan View

DRAFTING		MOLD SHOP		PRODUCTION	
DATE: Lifestyle USA Design	DATE:	MOLD I.D. #	DATE:		
DRAWN BY:	MADE BY:	MOLD DISPOSAL CODE	TAMPED BY:		
CHECKED BY:	CHECKED BY:		CHECKED BY:		
JOB #:	COLOR:	SCALE: 1 1/2" = 1'-0"	DATE: 08/14/08	MARK: BB42	
Bench Assignment: Block 274 East		PROJECT: Houston Pavilions			

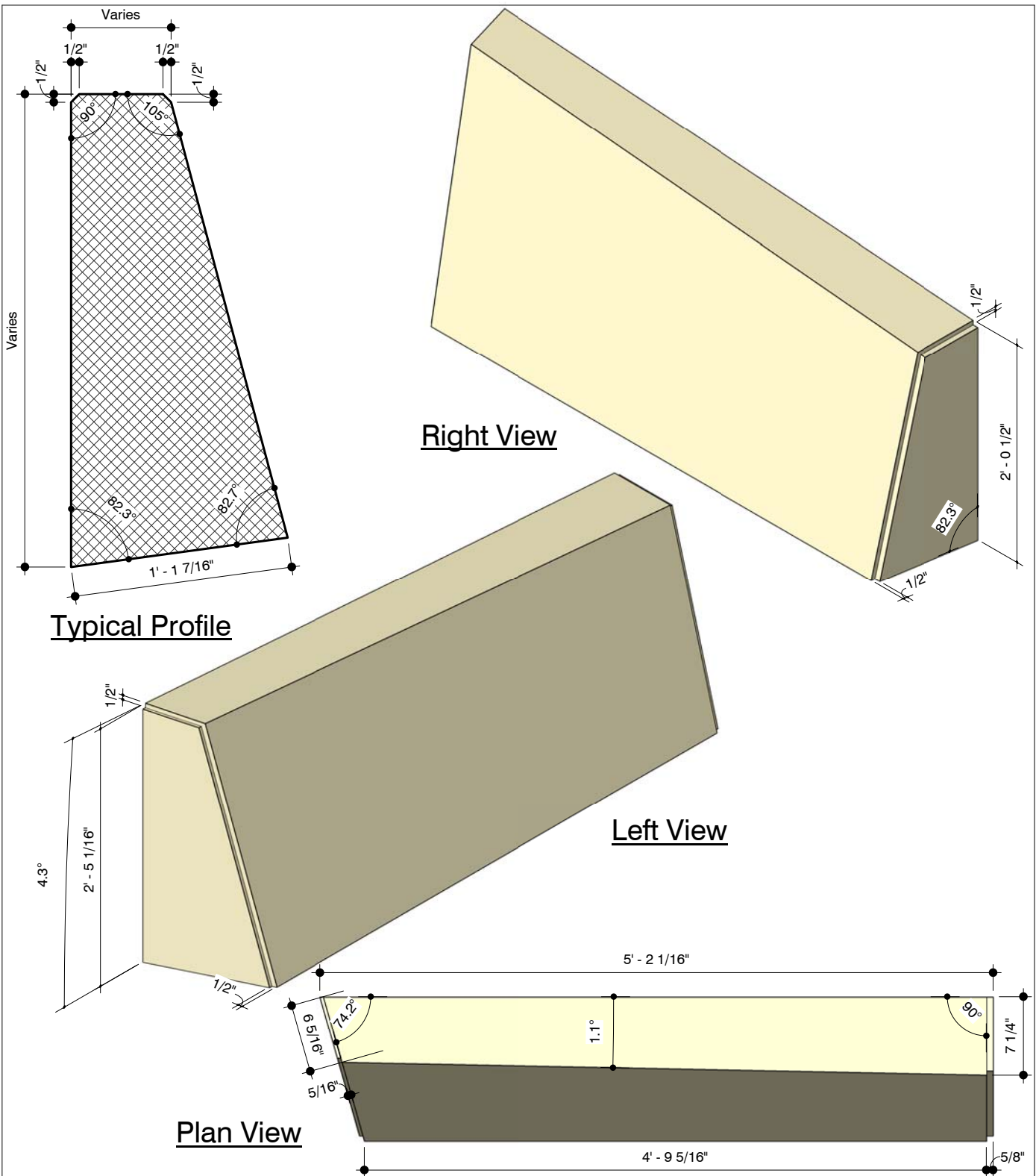

DRAFTING		MOLD SHOP		PRODUCTION	
DATE: Lifestyle USA Design	DATE:	MOLD I.D. #	DATE:		
DRAWN BY:	MADE BY:	MOLD DISPOSAL CODE	TAMPED BY:		
CHECKED BY:	CHECKED BY:		CHECKED BY:		
JOB #:	COLOR:	SCALE: 1 1/2" = 1'-0"	DATE: 08/14/08	Member	
Bench Assignment: Block 274 East		PROJECT: Houston Pavilions		MARK: BB43	

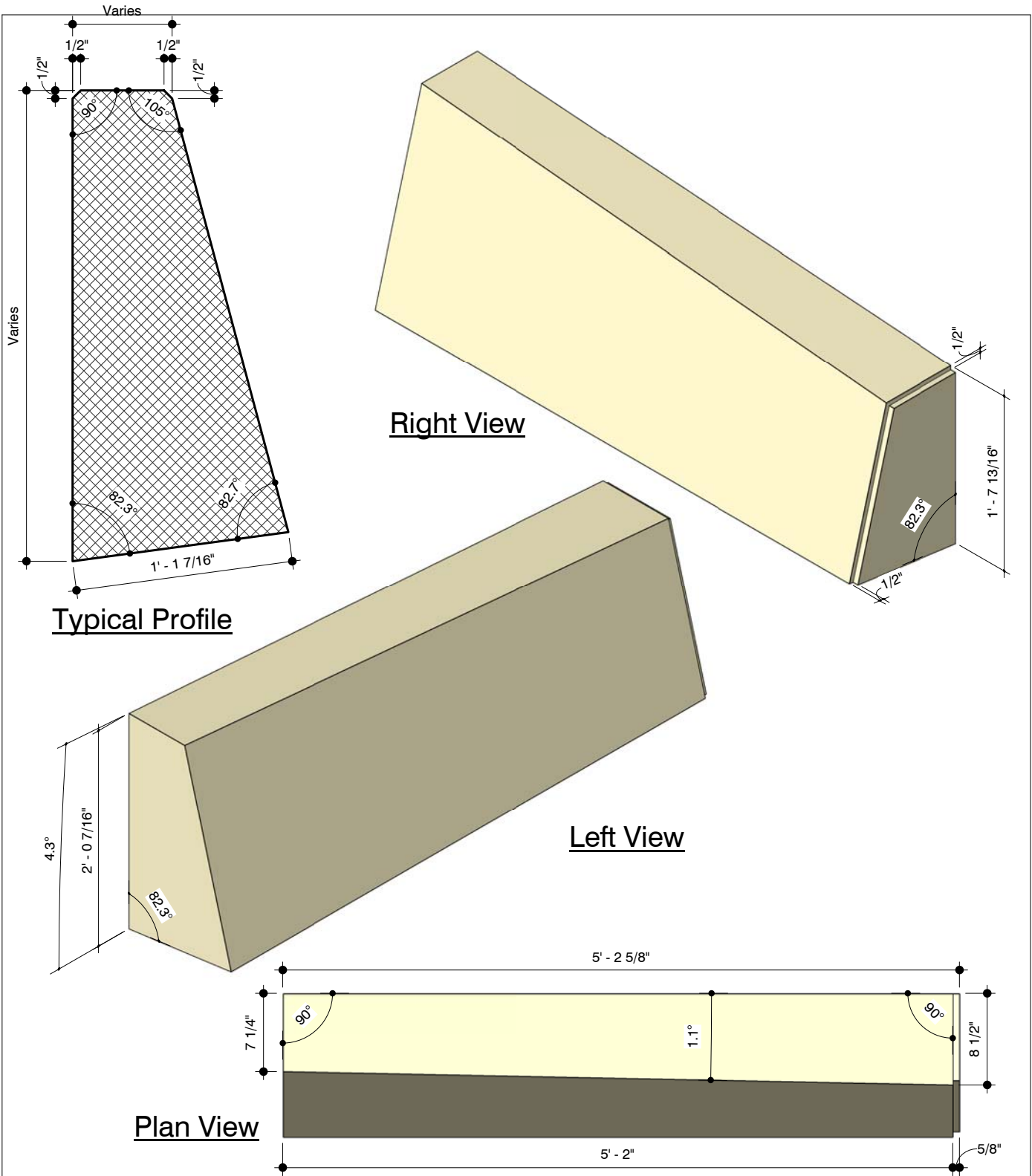

DRAFTING		MOLD SHOP		PRODUCTION	
DATE: Lifestyle USA Design	DATE:	MOLD I.D. #	DATE:		
DRAWN BY:	MADE BY:	MOLD DISPOSAL CODE	TAMPED BY:		
CHECKED BY:	CHECKED BY:		CHECKED BY:		
JOB #:	COLOR:	SCALE: 1 1/2" = 1'-0"	DATE: 08/14/08		
Bench Assignment: Block 274 East		PROJECT: Houston Pavilions			

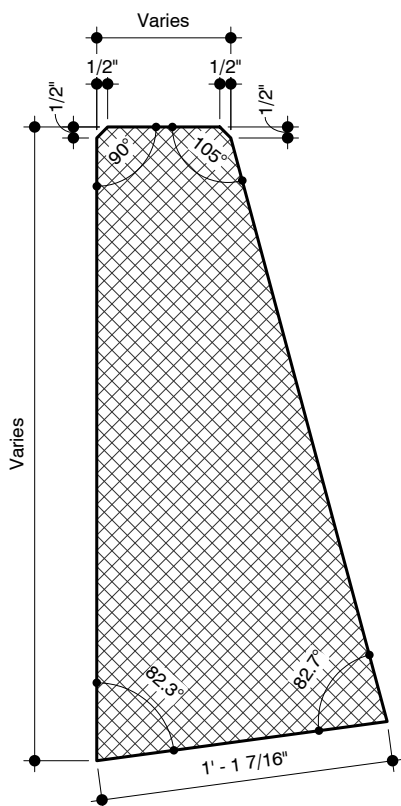

Typical Profile

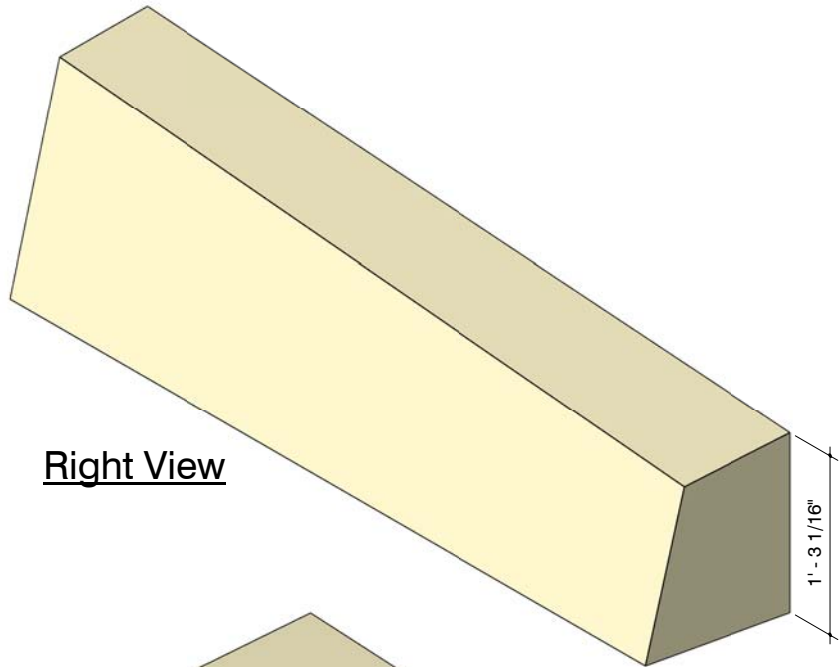

Right View

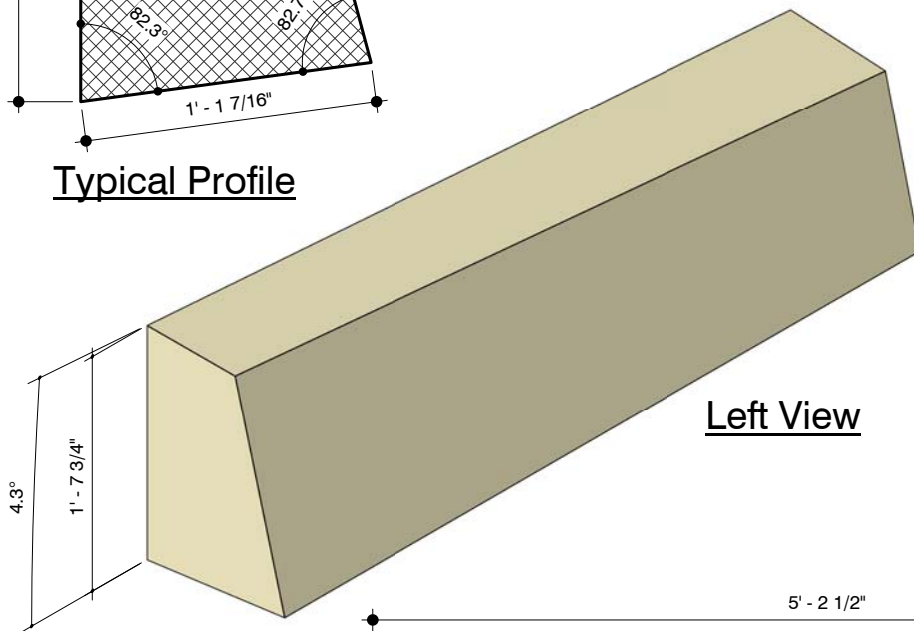

Left View

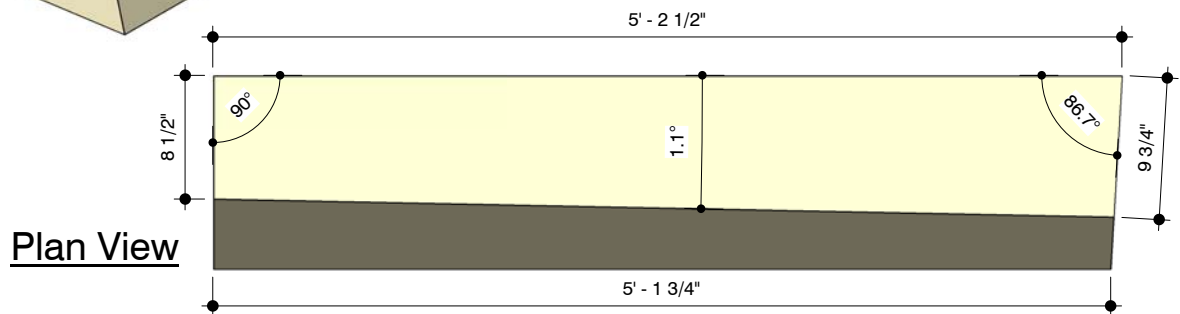

Plan View

DRAFTING		MOLD SHOP		PRODUCTION	
DATE: Lifestyle USA Design	DATE:	MOLD I.D. #	DATE:		
DRAWN BY:	MADE BY:	MOLD DISPOSAL CODE	TAMPED BY:		
CHECKED BY:	CHECKED BY:		CHECKED BY:		
JOB #:	COLOR:	SCALE: 1 1/2" = 1'-0"	DATE: 08/14/08		
Bench Assignment: Block 274 East		PROJECT: Houston Pavilions		MARK: BB45	